

E.ADEM v0.0.4.0

Work Progress

2009.6.13

2009.5.3

40 days

2009.6.13

138 days

2009.10.30

Previous Plan

- 1-2 weeks -> materials
- 1 week 1,4,5
- 1-2 weeks : 2,3,6,7,8,12
- 2 weeks 9 , 11'
- 2 weeks 10 ,11
- 2 weeks 13
- 2 weeks 14

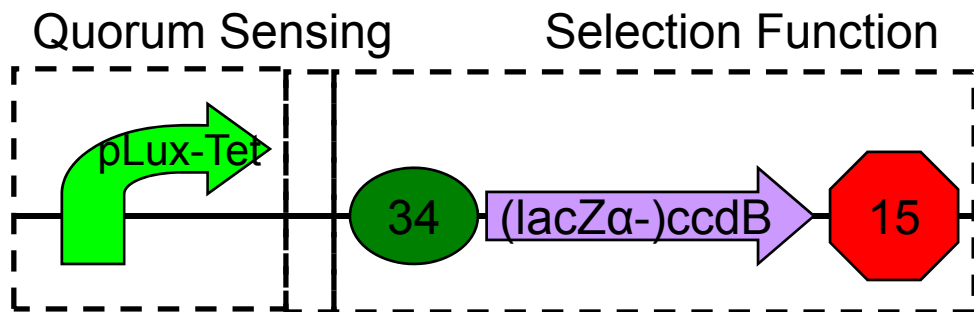
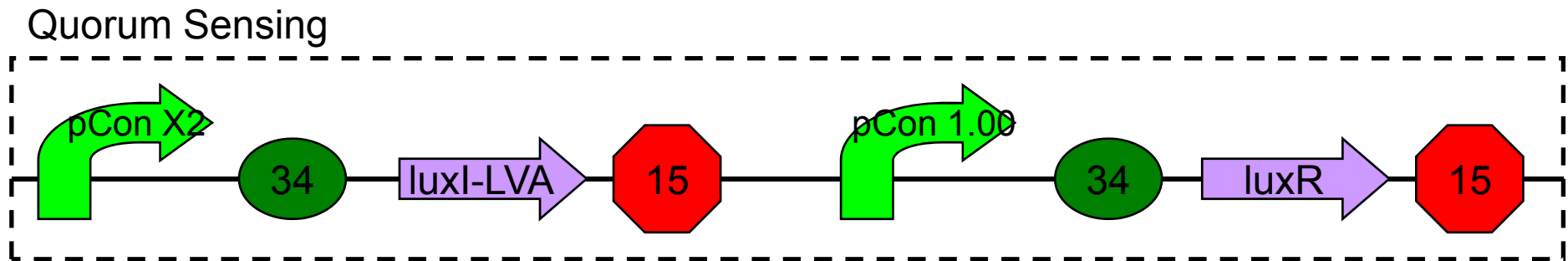
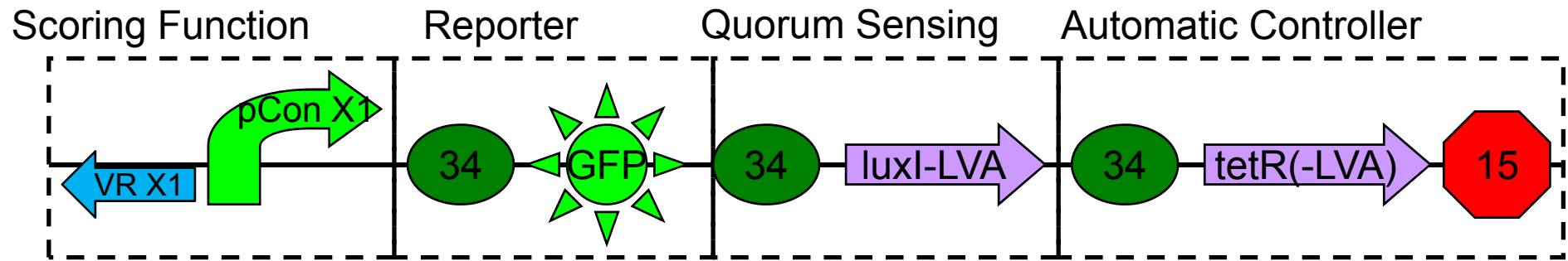

1. pLux-Tet
2. pLux-Tet + GFP
3. pCon + luxR + pLux-Tet
4. ccdB × 2
5. pCon × 8
6. pCon × 8 + GFP
7. pCon + luxR
8. pCon × 7 + luxI (AHL detection by 9 or GC-MS ?)
9. pCon + luxR + pLux-Tet + GFP (AHL)
10. pCon + luxR + pLux-Tet + ccdB × 2 (AHL)
11. tetR × 2
12. tetR × 2 + pCon + luxR + pLux-Tet (+ GFP)
13. (VR + pCon) × 8 + tetR × 2 + pCon + luxR + pLux-Tet (+ GFP) (AHL/aTc)
14. (pCon × 7 +) luxI + pCon + luxR + pLux-Tet (+ ccdB)
15. VR × 8
16. (VR + pCon) × 8
17. tetR + pCon + luxI + pCon + luxR + pLux-Tet (+ ccdB)
18. GFP + luxI + tetR + pCon + luxI + pCon + luxR + pLux-Tet (+ ccdB)
19. (VR + pCon) × 8 + tetR + pCon + luxI + pCon + luxR + pLux-Tet (+ ccdB)
20. (VR + pCon) × 8 + GFP + luxI + tetR + pCon + luxI + pCon + luxR + pLux-Tet (+ ccdB)

Waiting
Working
Done
Sequenced

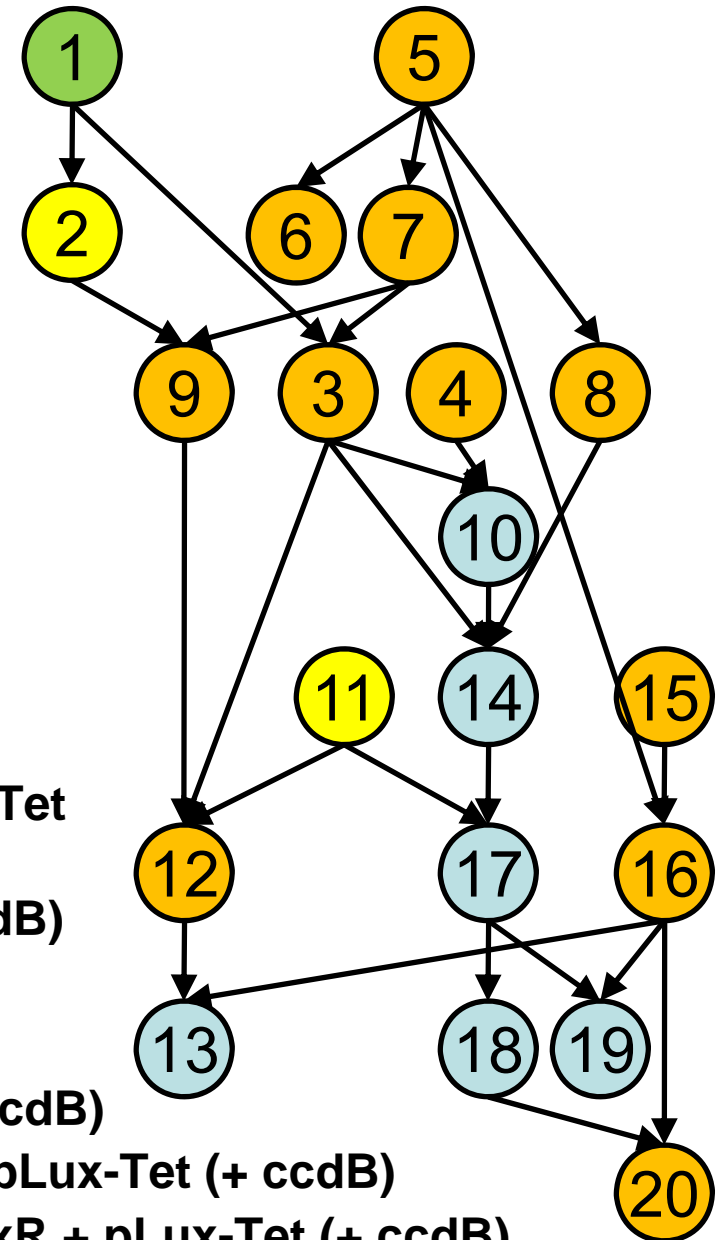

1

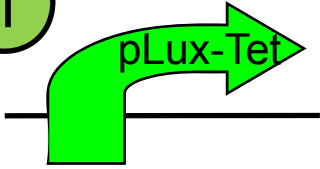

K176000 X+P with nicks
Sequence OK

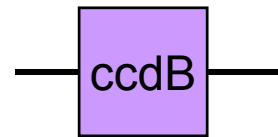

P1010 in pSB1A3 in DB 3.1
Length OK



pSB1A3 X+P
Length OK

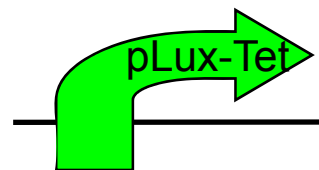

K176000 in pSB1A3
Sequence OK

2

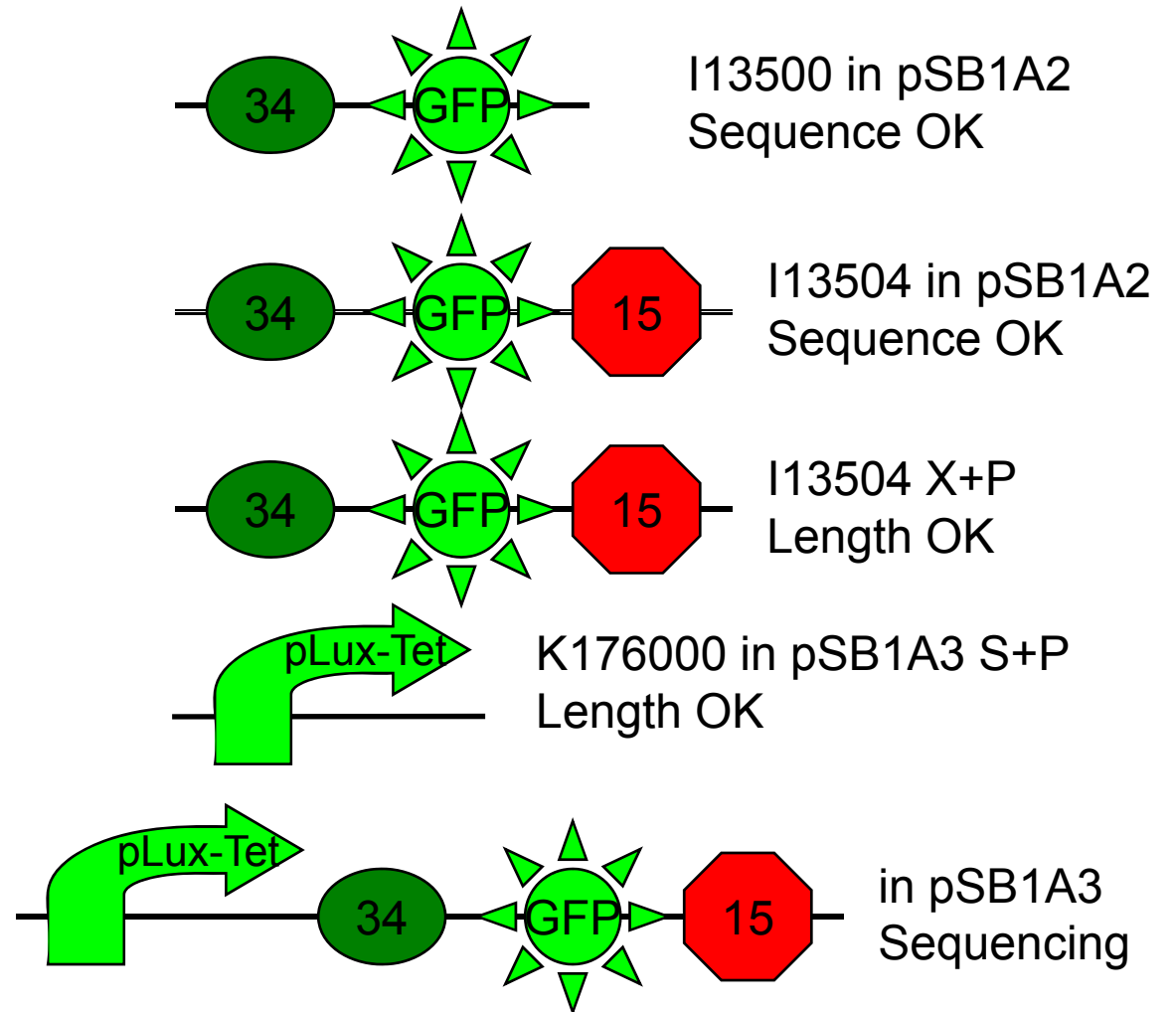

4



K145151 in pSB1A2 in DB 3.1

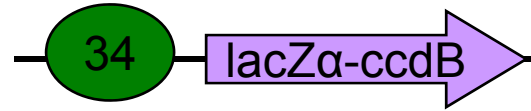

in pSB1A2 in DB 3.1

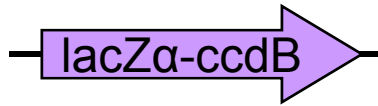

Sequencing
K176001 Fragment Length OK

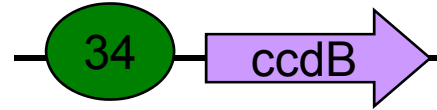

E+S
Waiting



B0034 in pSB1A2
Sequence OK

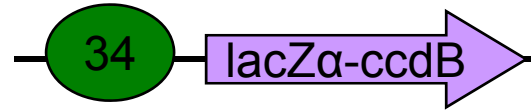

E+S
Waiting



B0034 in pSB1A2 S+P
Length OK

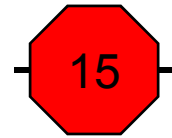

B0015 in pSB1AK3
Sequence OK

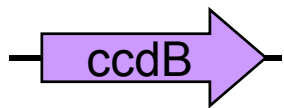

K145151 X+P
Digestion

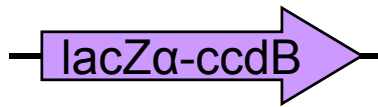

K176001 X+P
Length OK

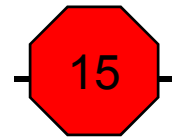

B0015 in pSB1AK3 E+X
Length OK

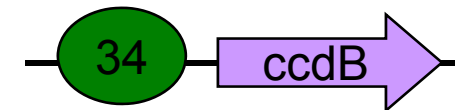

in pSB1A2 in DB 3.1
Waiting

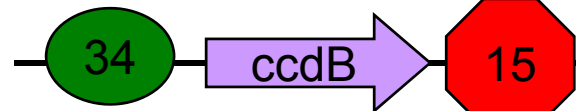

in pSB1AK3 in DB 3.1
Waiting

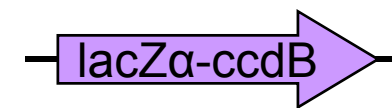

K176001 in pSB1A3 in DB 3.1
Sequencing

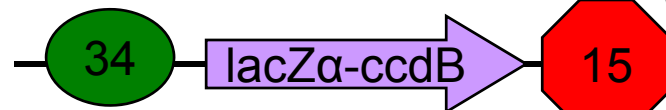

in pSB1AK3 in DB 3.1
Waiting

5

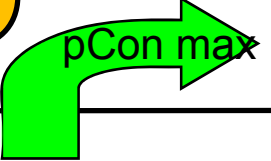
 pCon max J23119 in pSB1A2
Sequence OK

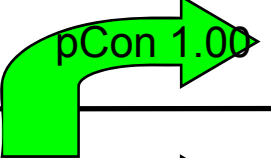
 pCon 1.00 J23100 in J61002
Length OK

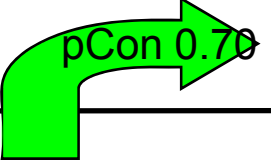
 pCon 0.70 J23101 in J61002
Length OK

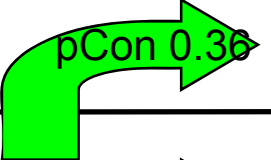
 pCon 0.36 J23107 in J61002
Length OK

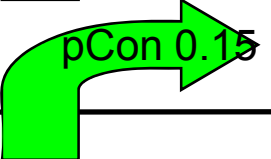
 pCon 0.15 J23115 in J61002
Length OK

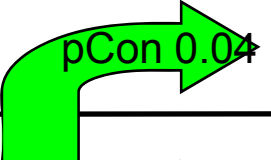
 pCon 0.04 J23109 in J61002
Length OK

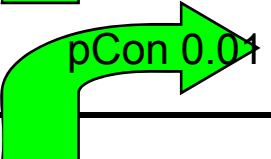
 pCon 0.04 J23103 in J61002
Length OK

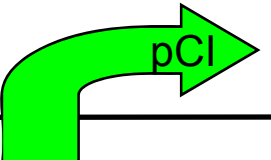
 pCl R0051 in pSB1A2
Sequencing

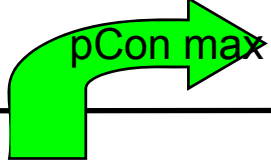
 pCon max J23119 X+P
Length OK

 pCon 1.00 J23100-J61002SF X+P
Length OK

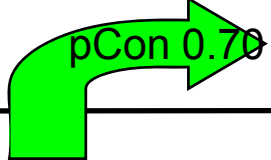
 pCon 0.70 J23101-J61002SF X+P
Length OK

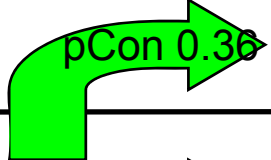
 pCon 0.36 J23107-J61002SF X+P
Length OK

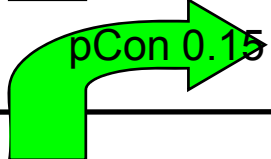
 pCon 0.15 J23115-J61002SF X+P
Length OK

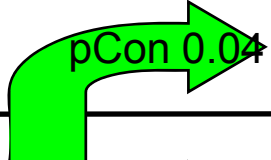
 pCon 0.04 J23109-J61002SF X+P
Length OK

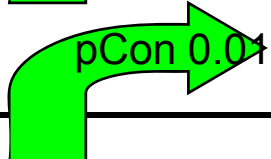
 pCon 0.04 J23103-J61002SF X+P
Length OK

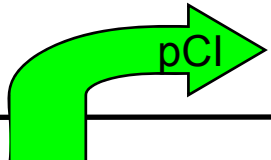
 pCl R0051 X+P
Digestion

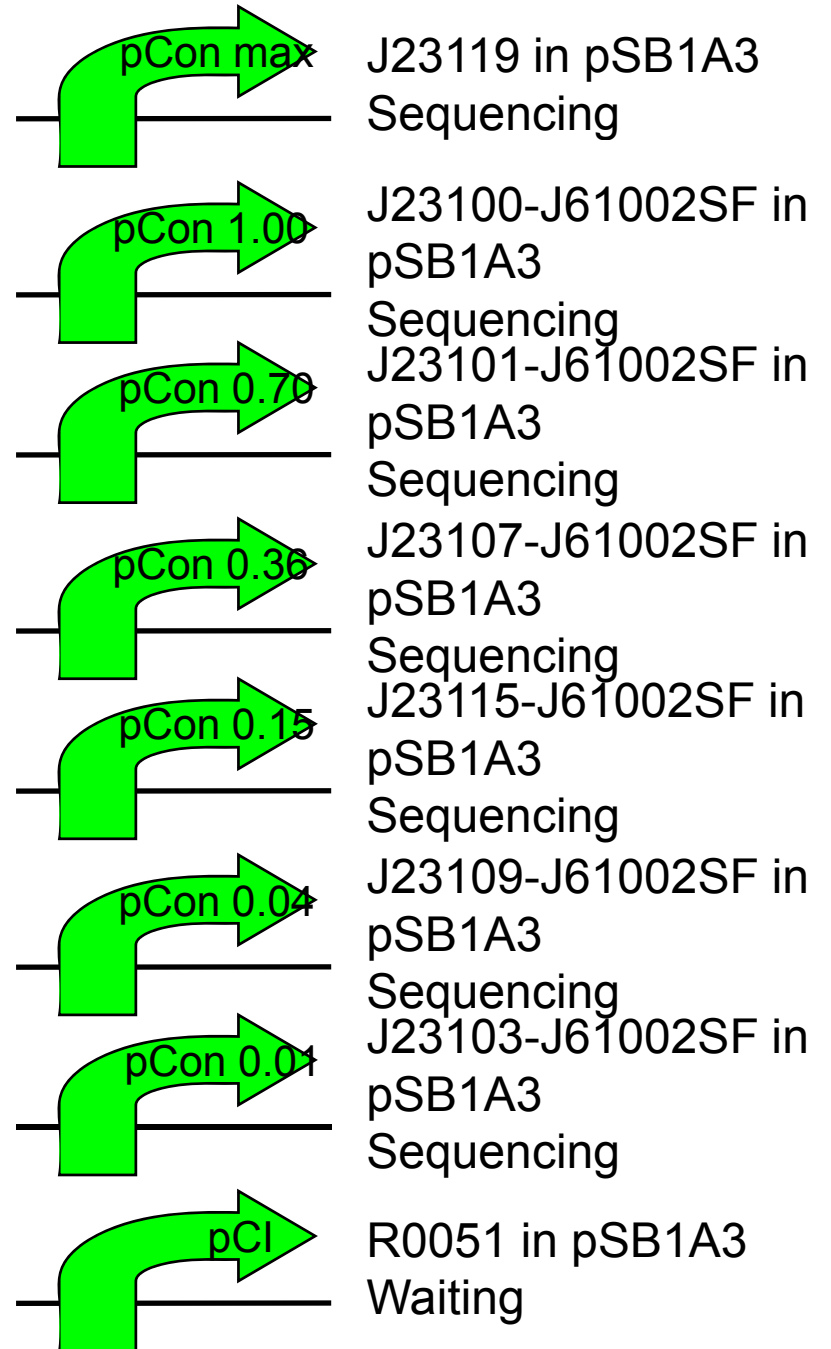

6

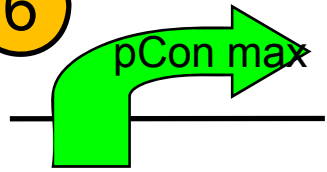

J23119 in
pSB1A3 S+P
Digestion

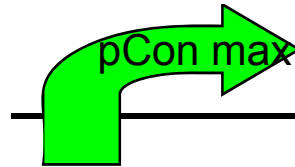

34

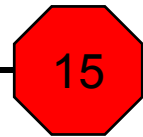

in pSB1A3
Waiting

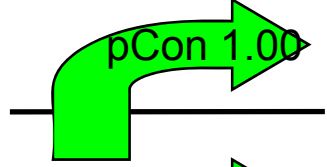

J23100 in
pSB1A3 S+P
Digestion

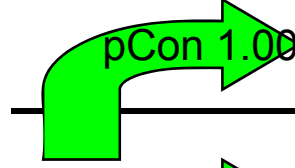

34

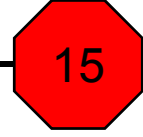

in pSB1A3
Waiting

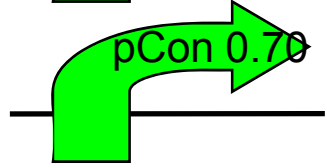

J23101 in
pSB1A3 S+P
Digestion

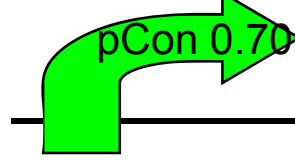

34

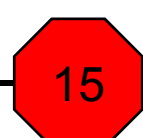

in pSB1A3
Waiting

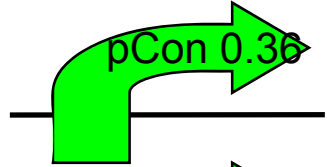

J23107 in
pSB1A3 S+P
Digestion

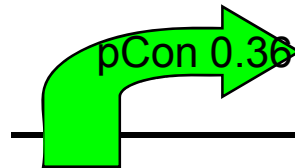

34

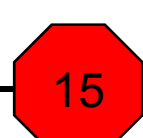

in pSB1A3
Waiting

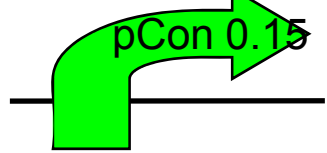

J23115 in
pSB1A3 S+P
Digestion

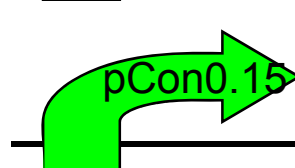

34

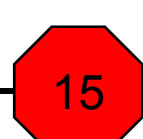

in pSB1A3
Waiting

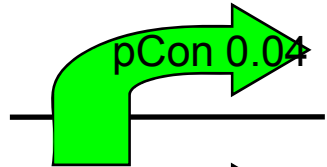

J23109 in
pSB1A3 S+P
Digestion

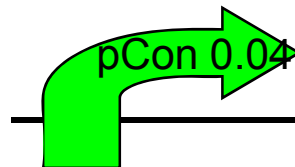

34

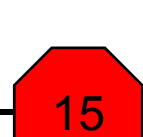

in pSB1A3
Waiting

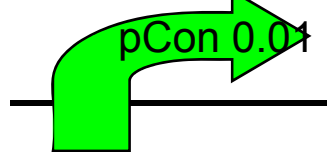

J23103 in
pSB1A3 S+P
Digestion

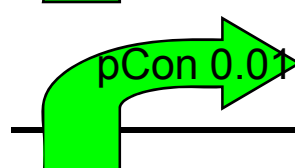

34

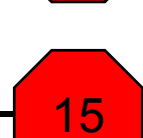

in pSB1A3
Waiting

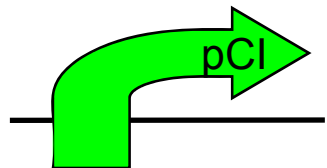

R0051 in
pSB1A3 S+P
Waiting

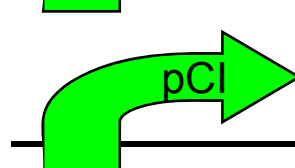

34

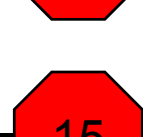

in pSB1A3
Waiting

7

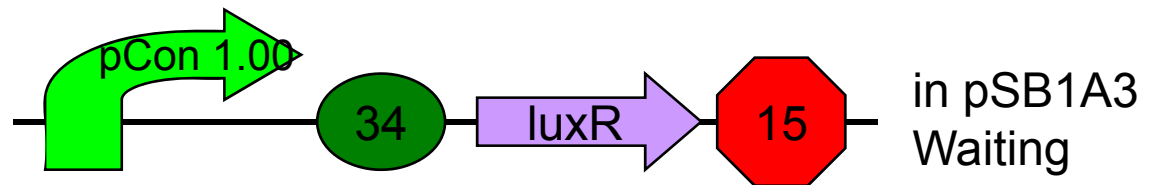
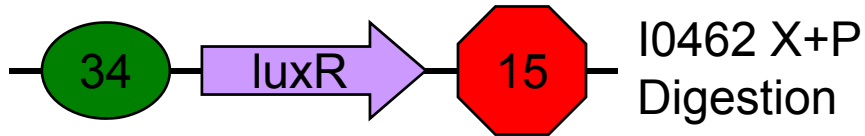
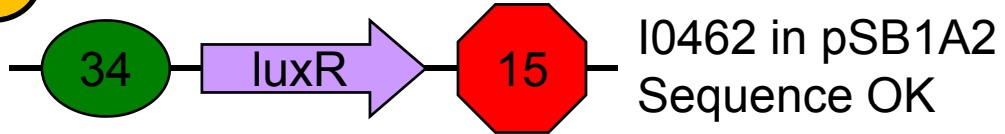

8



K082014 in pSB1AK3
Sequence OK

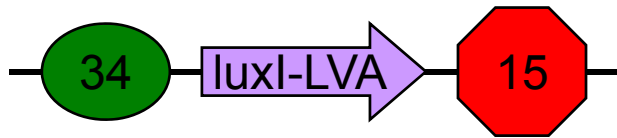

K082014 X+P
Digestion

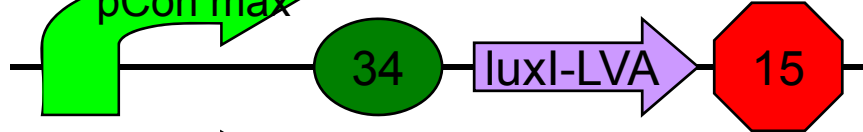
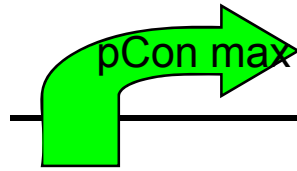

in pSB1A3
Waiting

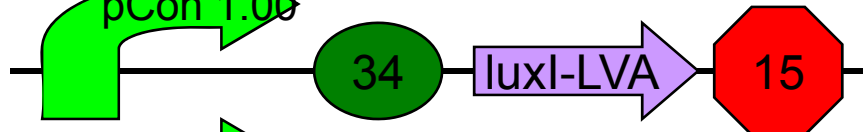
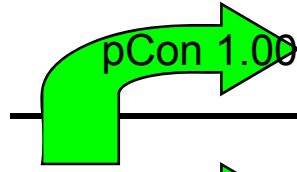

in pSB1A3
Waiting

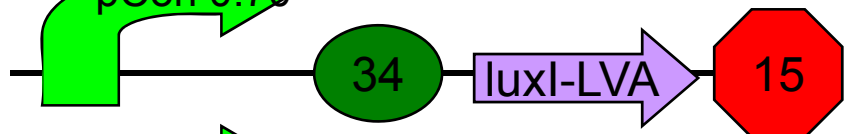
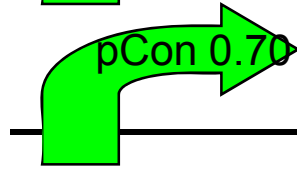

in pSB1A3
Waiting

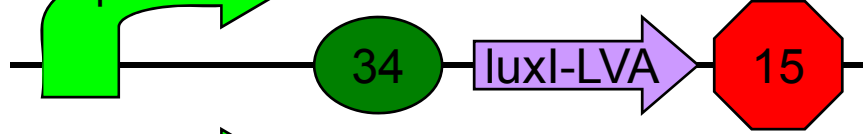
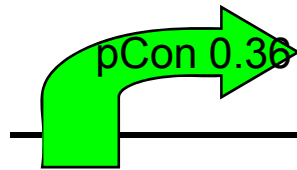

in pSB1A3
Waiting

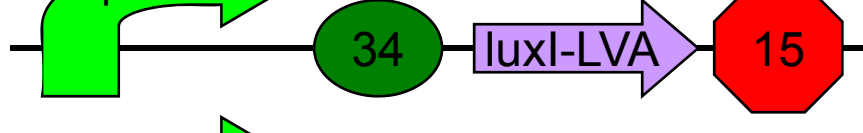
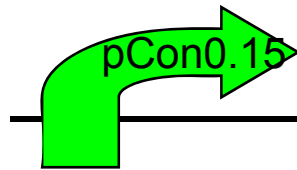

in pSB1A3
Waiting

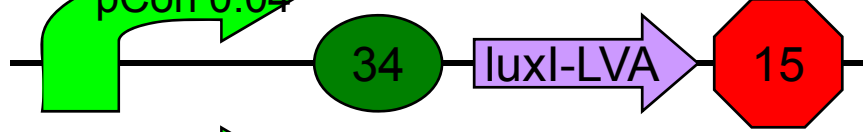
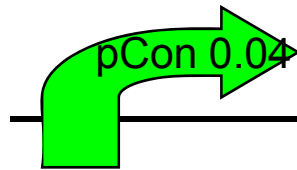

in pSB1A3
Waiting

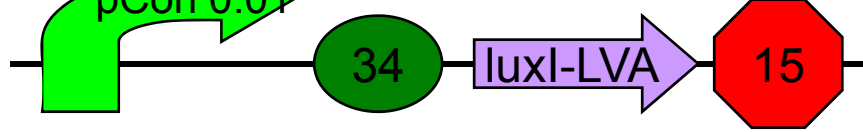
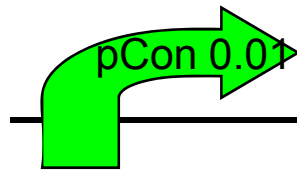

in pSB1A3
Waiting

3

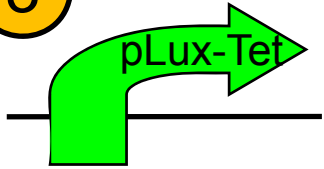

K176000 in pSB1A3 E+X
Digestion

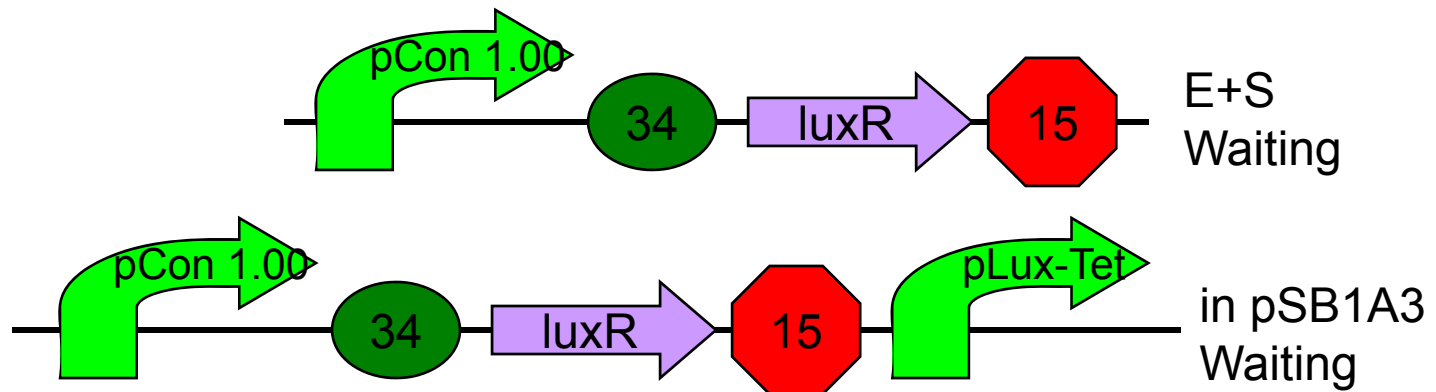

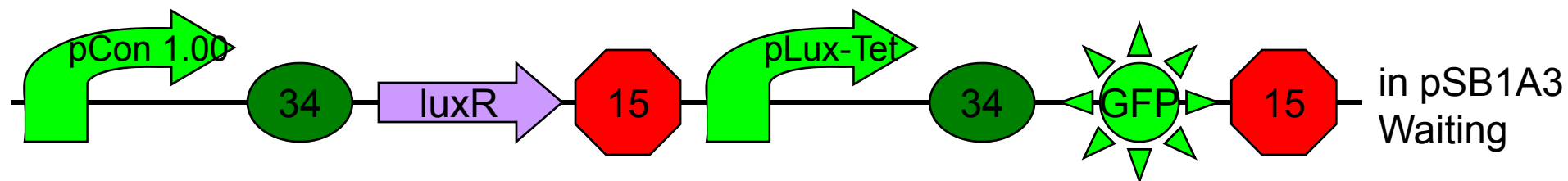
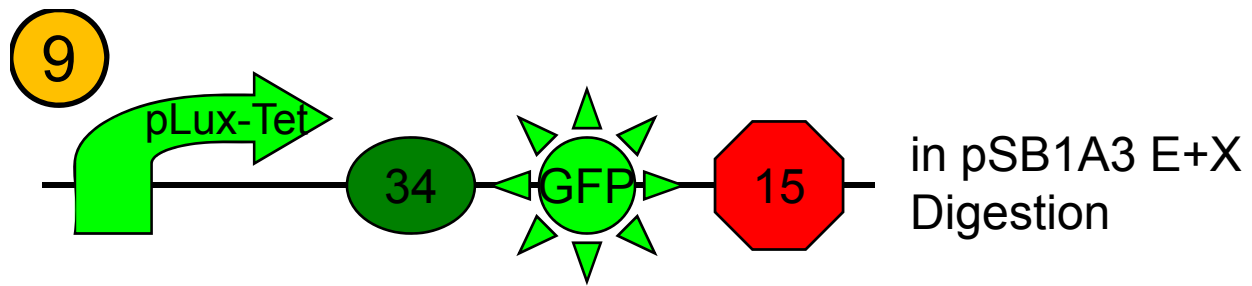

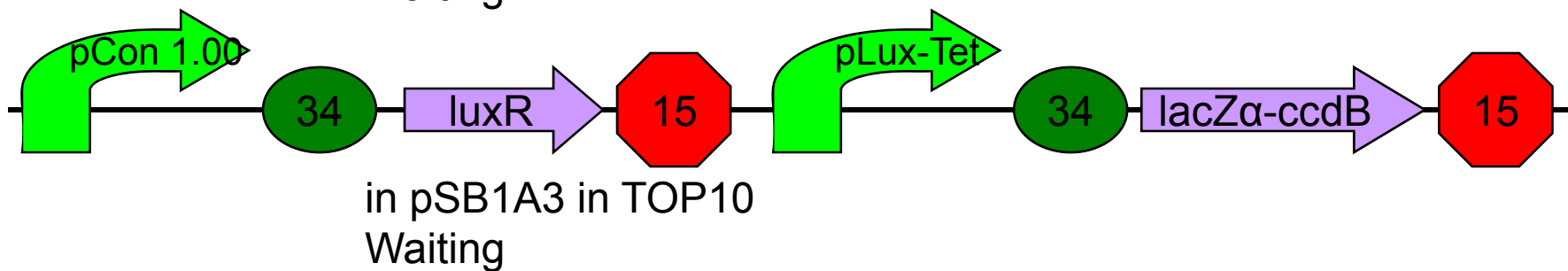
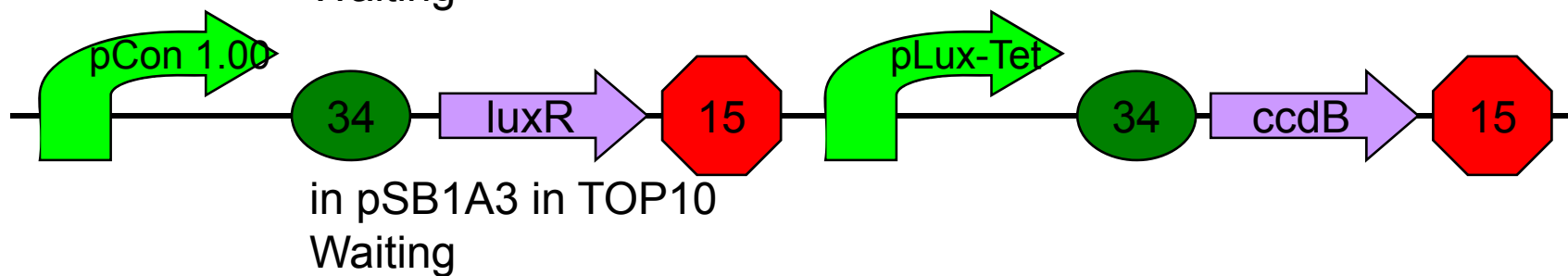
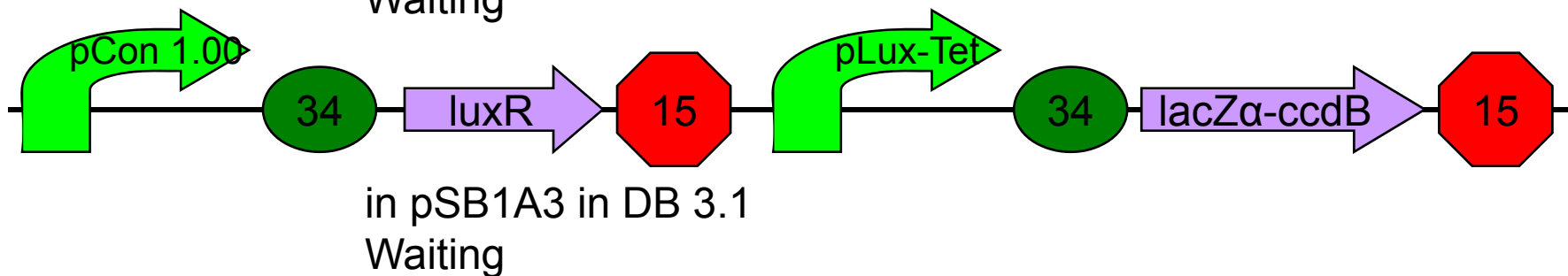
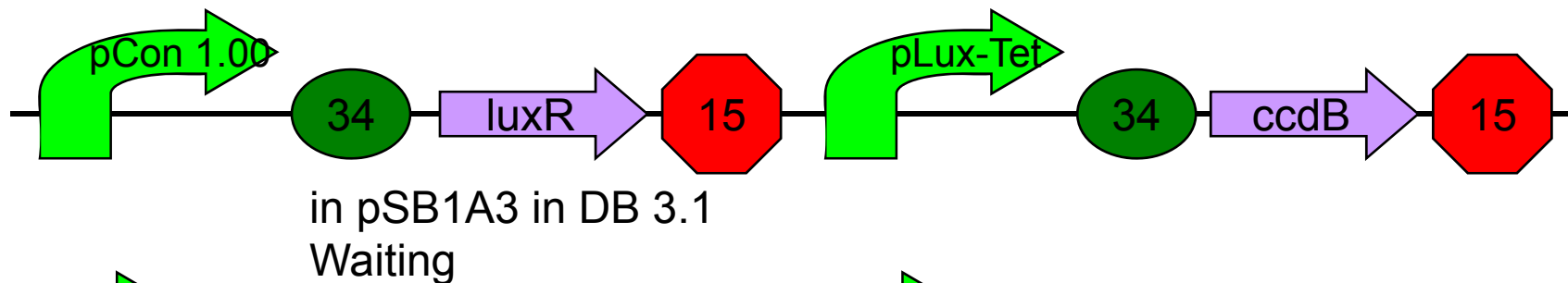
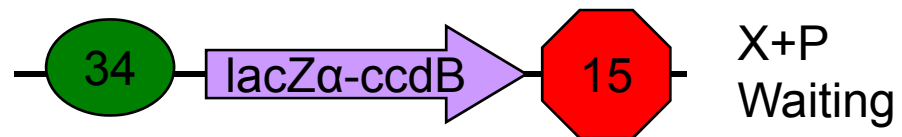
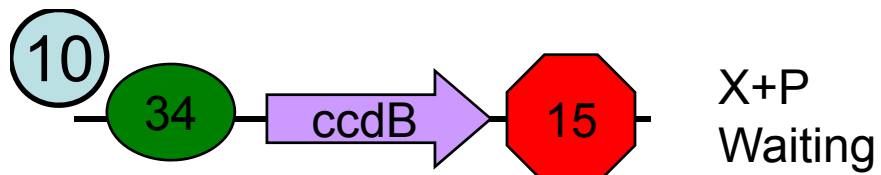

11

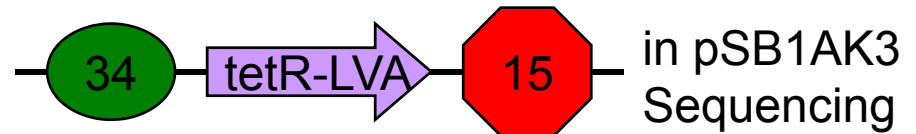
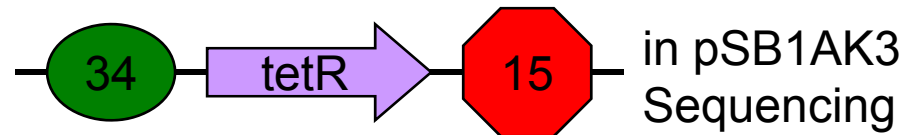
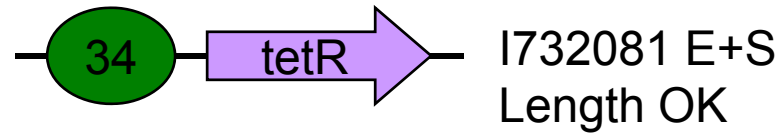
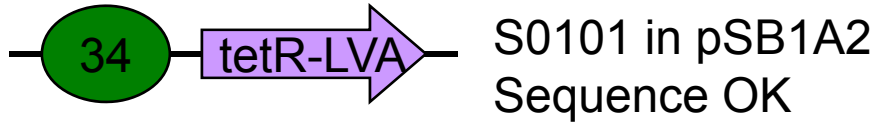
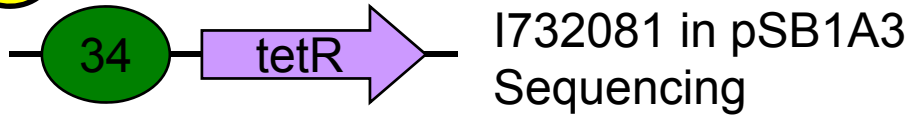

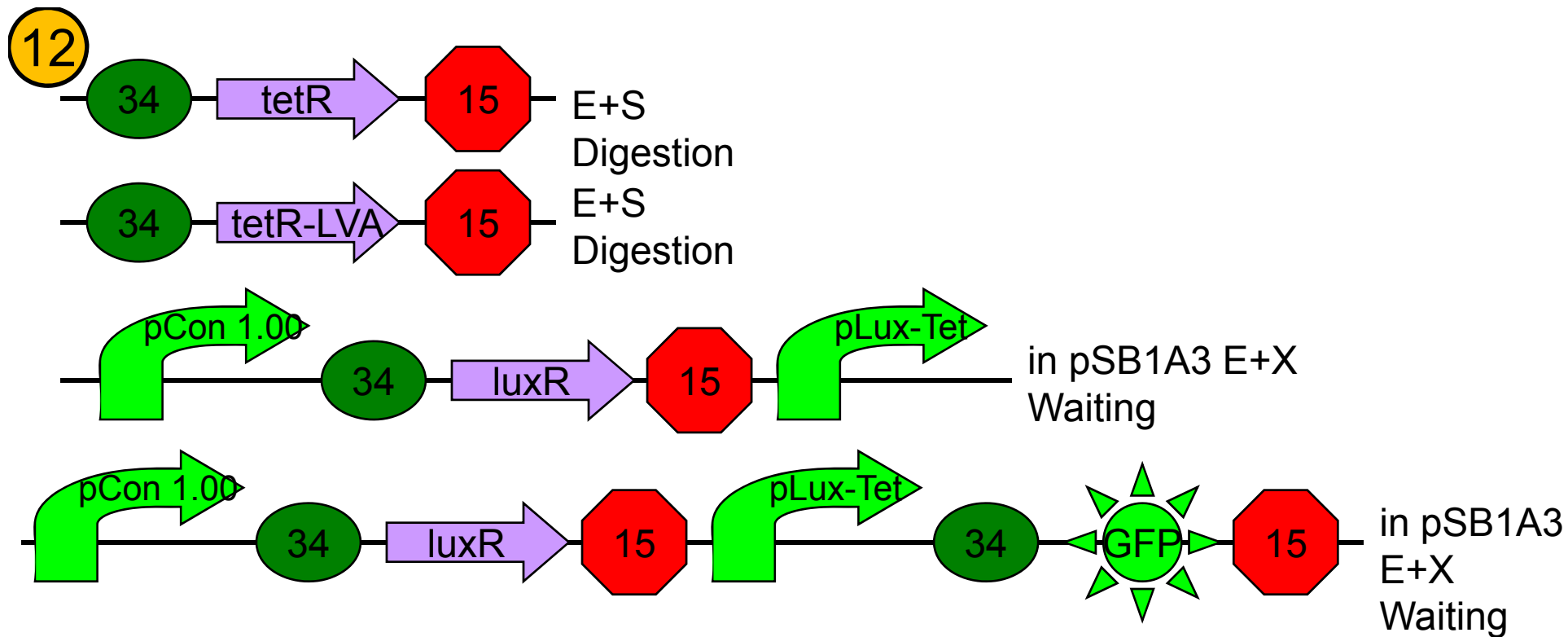

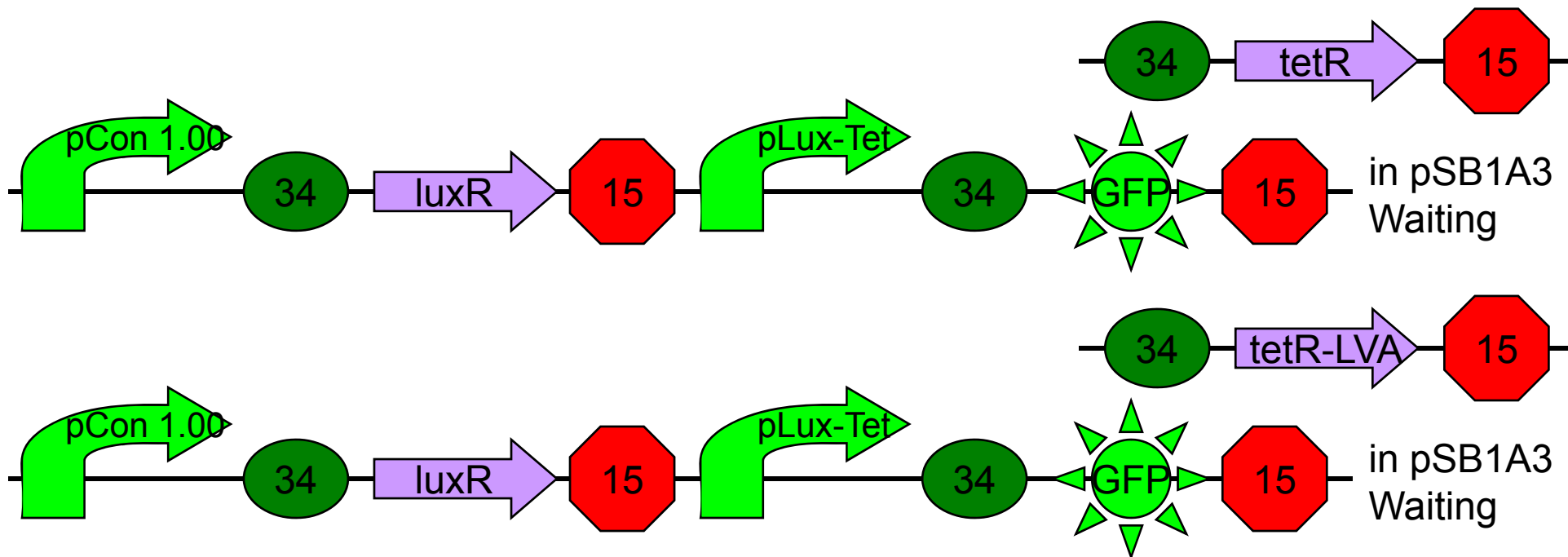
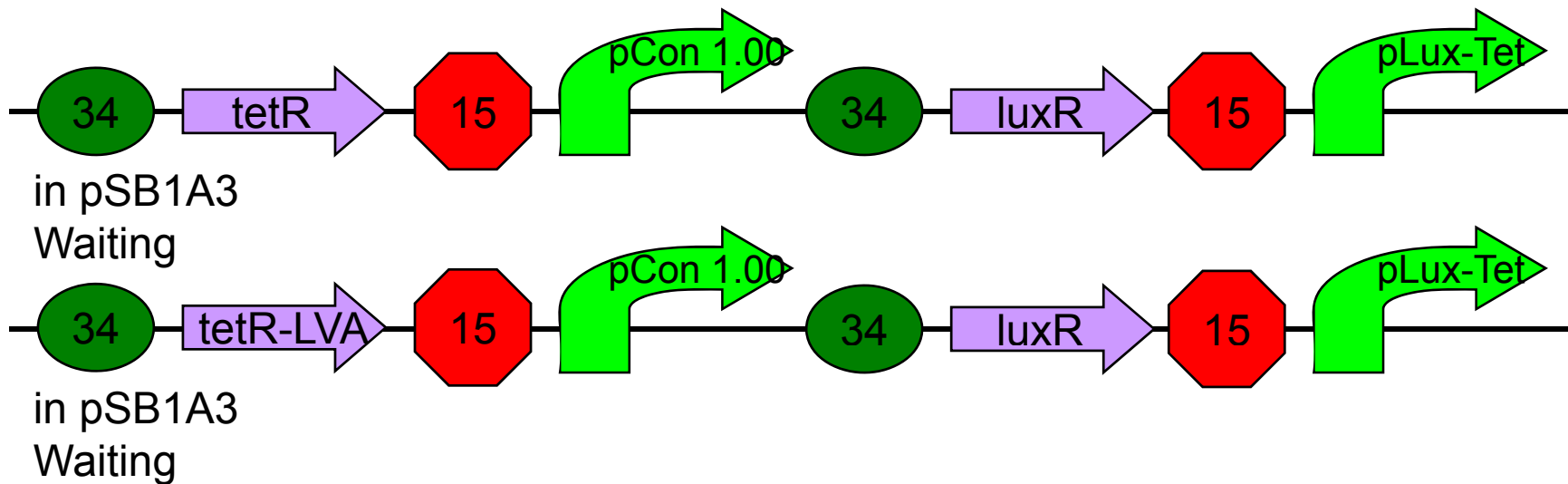

15

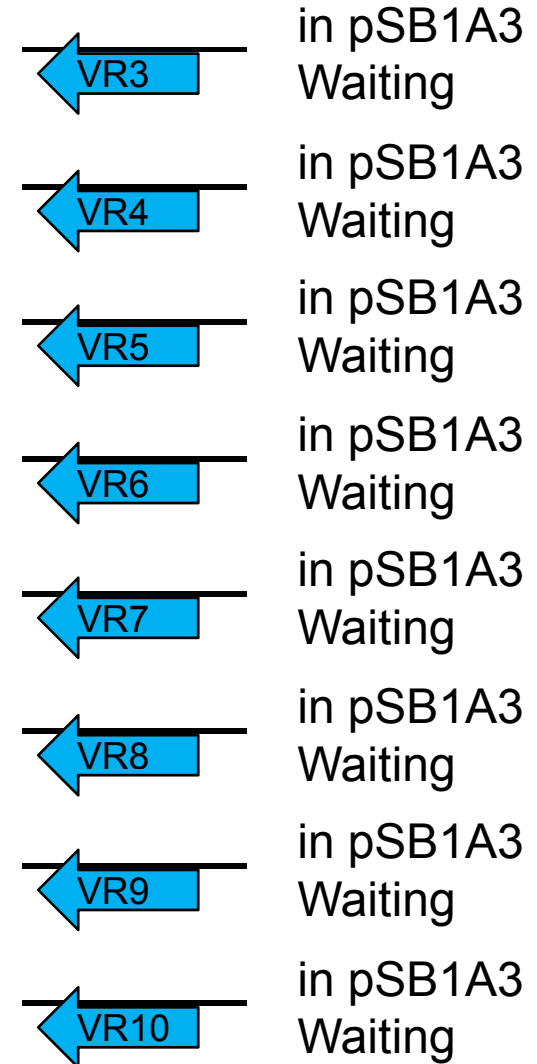
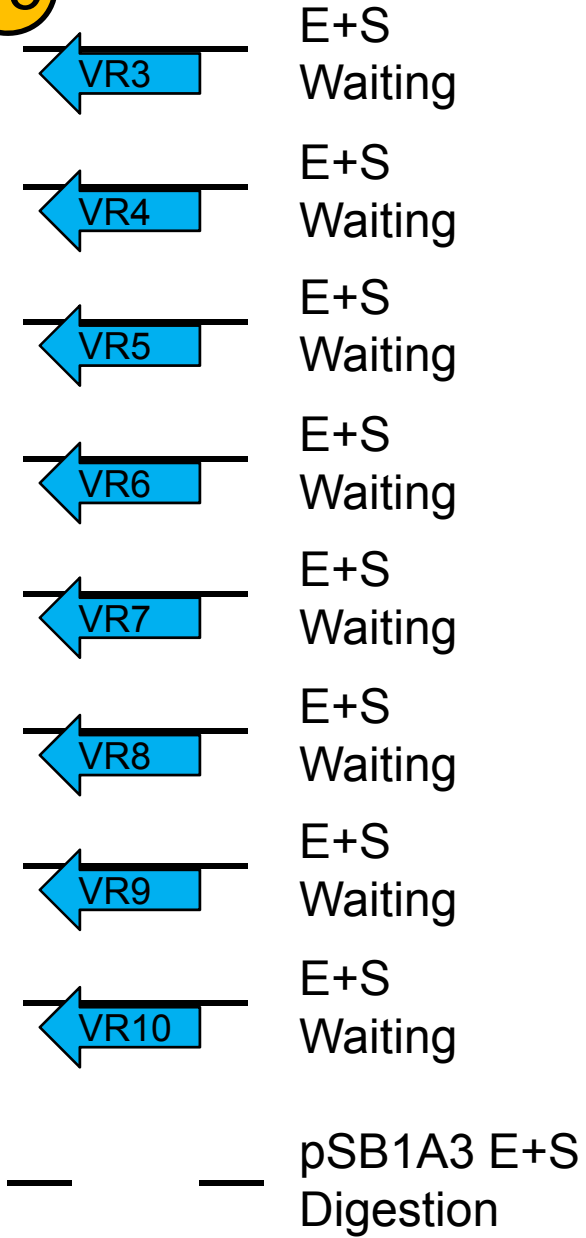

16

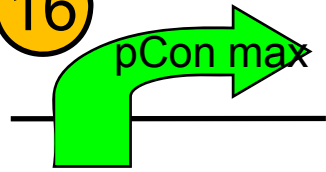

J23119 in pSB1A3
E+X
Digestion

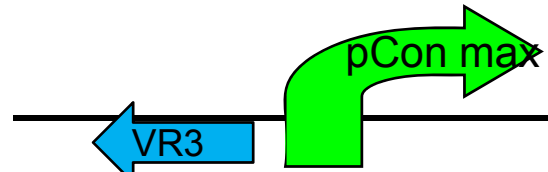

in pSB1A3
Waiting

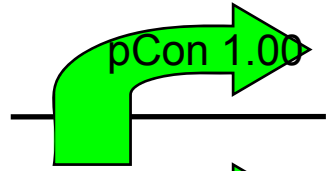

J23100-J61002SF in
pSB1A3E+X
Digestion

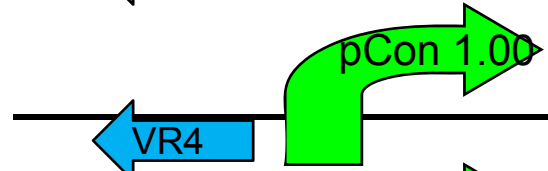

in pSB1A3
Waiting

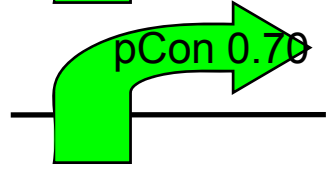

J23101-J61002SF in
pSB1A3E+X
Digestion

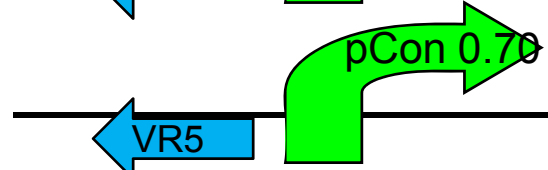

in pSB1A3
Waiting

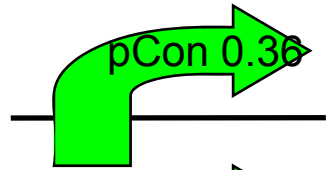

J23107-J61002SF in
pSB1A3E+X
Digestion

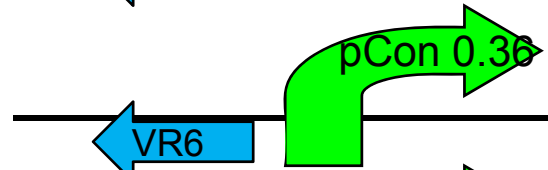

in pSB1A3
Waiting

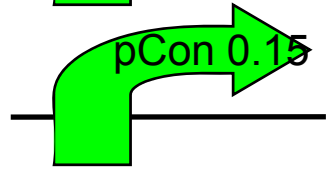

J23115-J61002SF in
pSB1A3E+X
Digestion

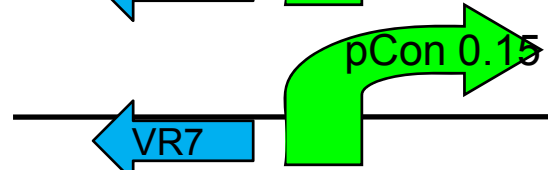

in pSB1A3
Waiting

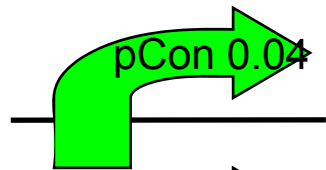

J23109-J61002SF in
pSB1A3E+X
Digestion

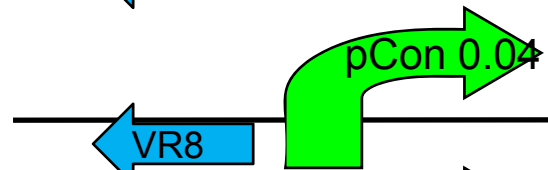

in pSB1A3
Waiting

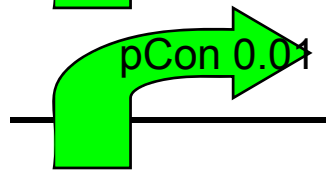

J23103-J61002SF in
pSB1A3E+X
Digestion

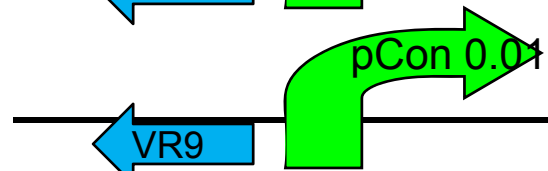

in pSB1A3
Waiting

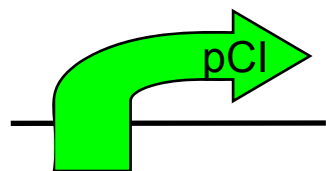

R0051 in pSB1A3
Waiting

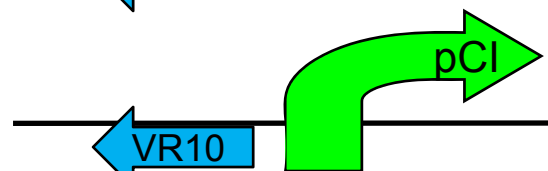

in pSB1A3
Waiting

20

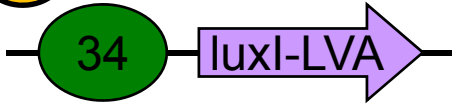

C0261 in pSB1A2
Sequence OK