

**E.ADEM v0.0.5.2**

**2009.8.22**

2009.5.3

110 days

2009.8.22

68 days

2009.10.30

# Outline

- Assembly
- Measurement
  - General Conditions
  - GFP
  - AHL
  - CcdB
  - LacZ $\alpha$
- Wiki
  - Team project description
  - Notebook
- Instructional Videos

# Assembly

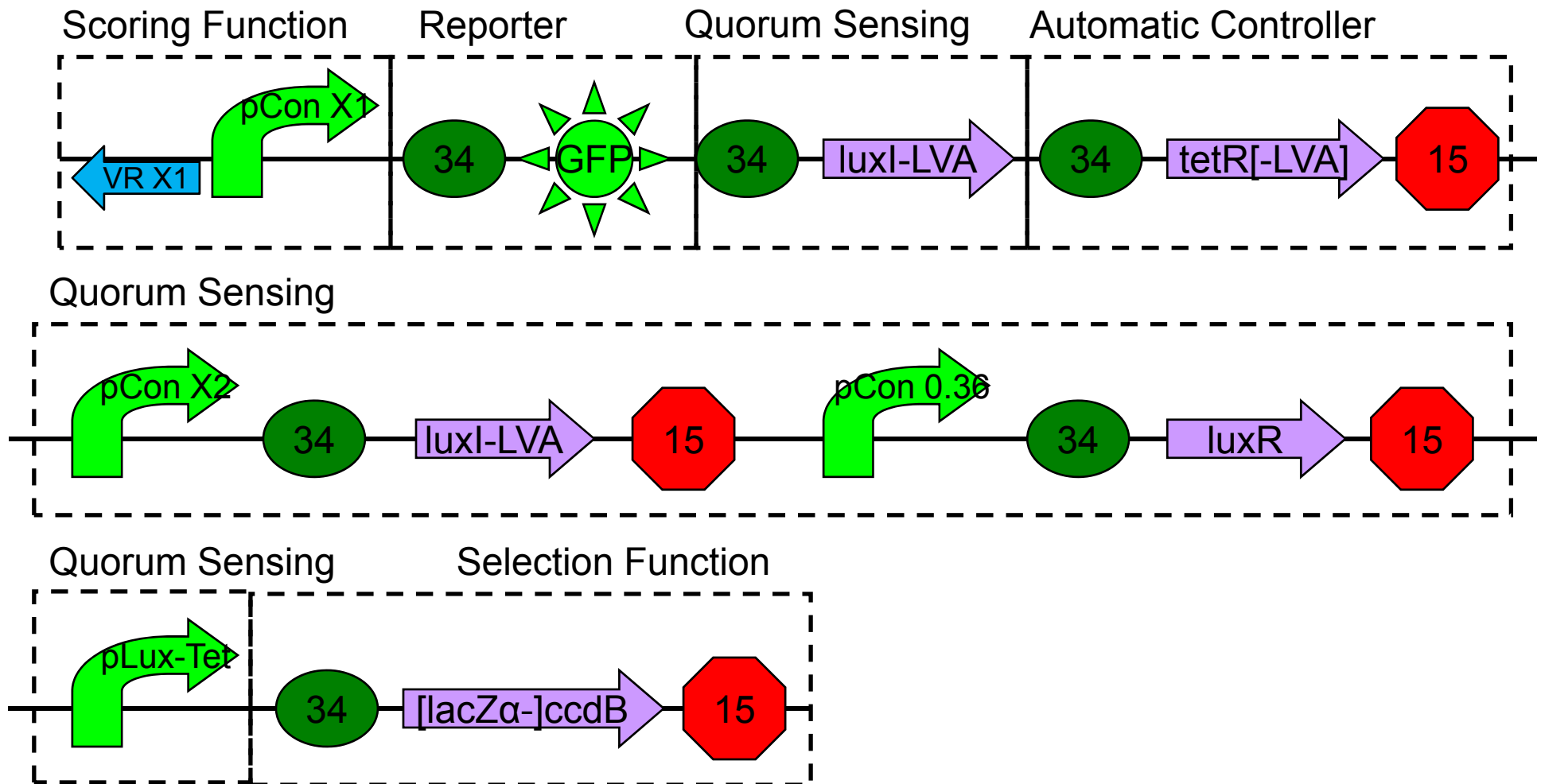

1. pLux-Tet
2. pLux-Tet + GFP
3. pCon + luxR × 4 + pLux-Tet
4. ccdB × 4
5. pCon × 8
6. pCon × 8 + GFP
7. pCon + luxR
8. pCon × 7 + luxI (AHL detection by 9 or GC-MS ?)
9. pCon + luxR × 4 + pLux-Tet + GFP (AHL)
10. pCon + luxR × 4 + pLux-Tet + ccdB × 4 (AHL)
11. tetR × 2
12. tetR × 2 + pCon × 2 + luxR + pLux-Tet [+ GFP]
13. pCon × 4 + tetR × 2 + pCon × 2 + luxR + pLux-Tet [+ GFP] (AHL/aTc)
14. [pCon × 7 +] luxI + pCon × 2 + luxR + pLux-Tet [+ ccdB × 2]
15. VR × 10
16. (VR + pCon) × 7
17. tetR + pCon + luxI + pCon + luxR + pLux-Tet [+ ccdB]
18. [GFP +] luxI + tetR + pCon + luxI + pCon + luxR + pLux-Tet [+ ccdB]
19. (VR + pCon) × 6 + tetR + pCon + luxI + pCon + luxR + pLux-Tet [+ ccdB]
20. (VR + pCon) × 6 + GFP + luxI + tetR + pCon + luxI + pCon + luxR + pLux-Tet [+ ccdB]

Waiting  
Working  
Done  
Sequenced

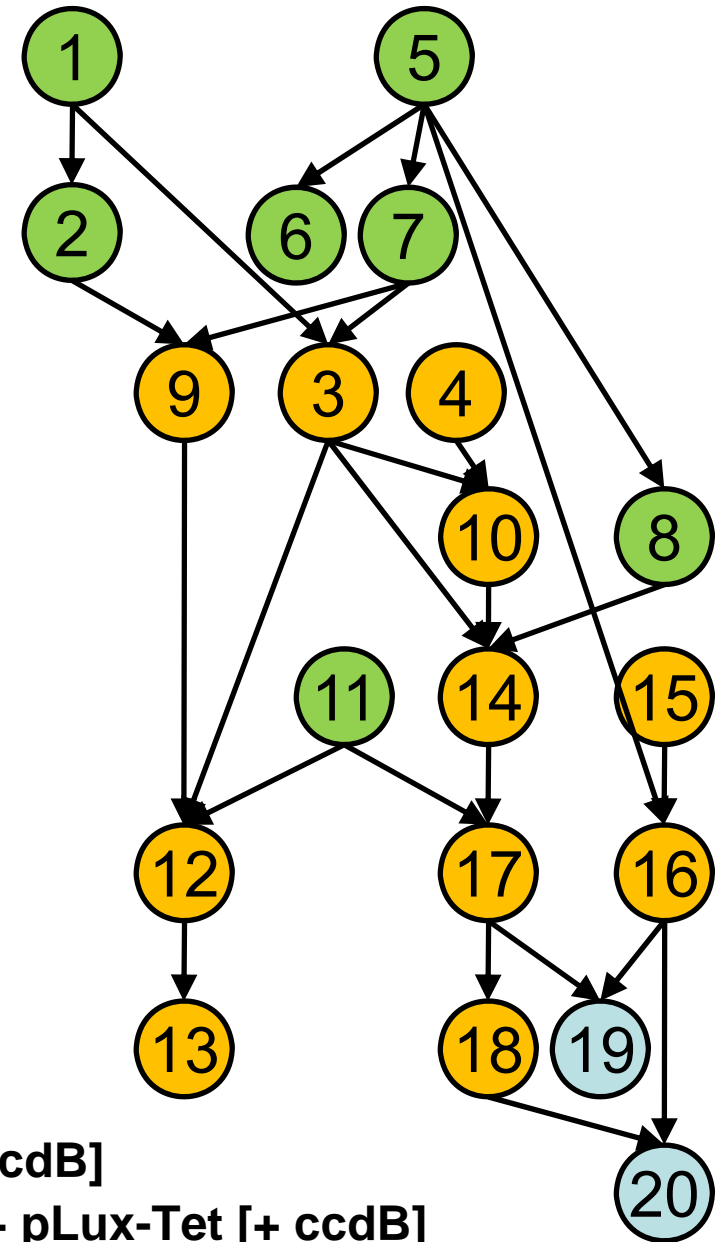

### Evolution Object

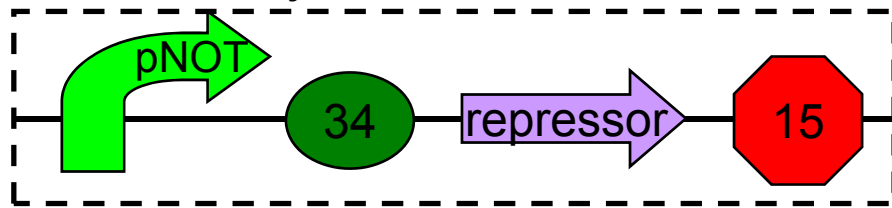

### Scoring Function

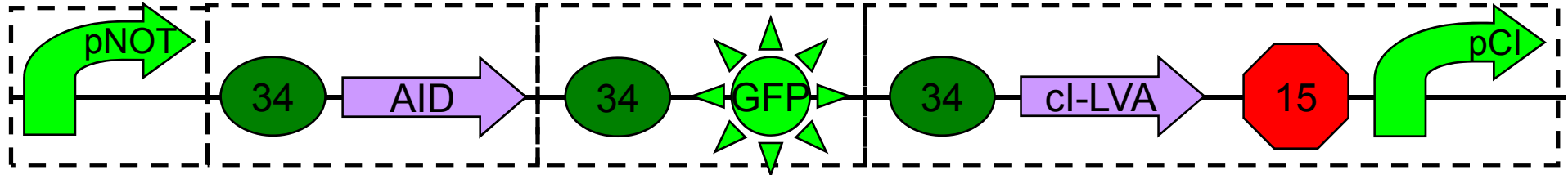

### Quorum Sensing

### Automatic Controller

### Quorum Sensing

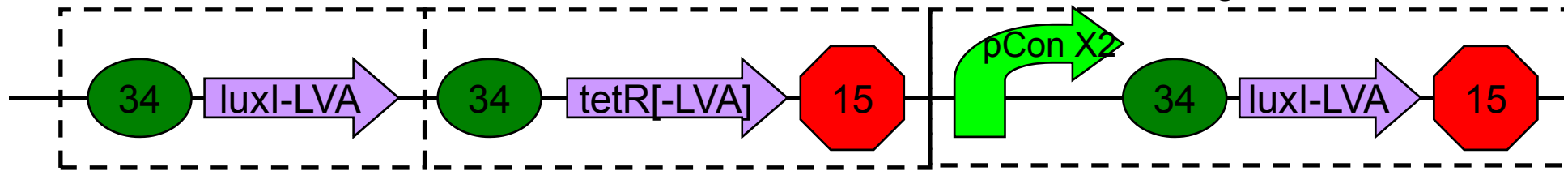

### Quorum Sensing

### Selection Function

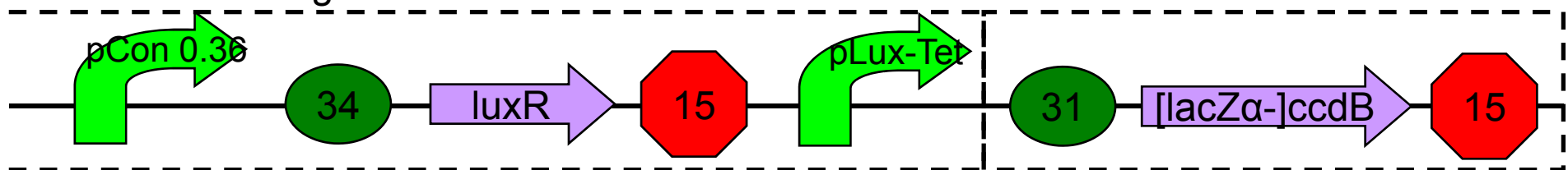

- 21. *cl* + p*Cl*
- 22. *cl* + p*Cl* + GFP
- 23. (VR + pCon) × 7 + *cl* + p*Cl* + GFP
- 24. *cl* + p*Cl* + *luxI* + *tetR* + pCon + *luxI* + pCon + *luxR* + pLux-Tet [+ *ccdB*]
- 25. AID
- 26. [AID +] GFP + *cl* + p*Cl* + *luxI* + *tetR* + pCon + *luxI* + pCon + *luxR* + pLux-Tet [+ *ccdB*]
- 27. (VR + pCon) × 7 + GFP + *cl* + p*Cl* + *luxI* + *tetR* + pCon + *luxI* + pCon + *luxR* + pLux-Tet [+ *ccdB*]
- 28. pNOT
- 29. pNOT + GFP
- 30. pNOT + [AID +] GFP + *cl* + p*Cl* + *luxI* + *tetR* + pCon + *luxI* + pCon + *luxR* + pLux-Tet [+ *ccdB*]
- 31. repressor
- 32. pNOT + repressor

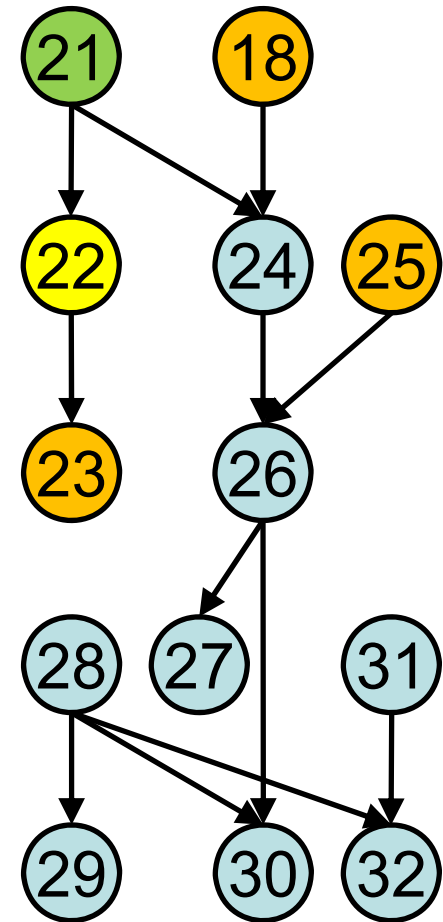

1

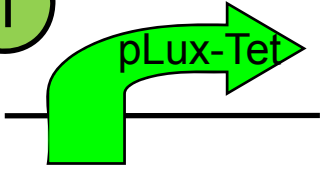

K176000 X+P with nicks  
Sequence OK



G00100  
Synthesis OK



G00101  
Synthesis OK

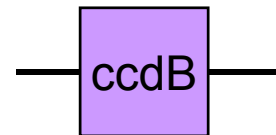

P1010 in pSB1A3 in DB 3.1  
Length OK



pSB1A3 X+P  
Length OK

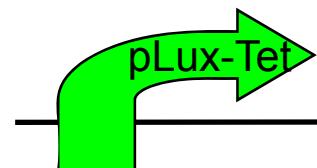

K176000 in pSB1A3  
Sequence OK



2

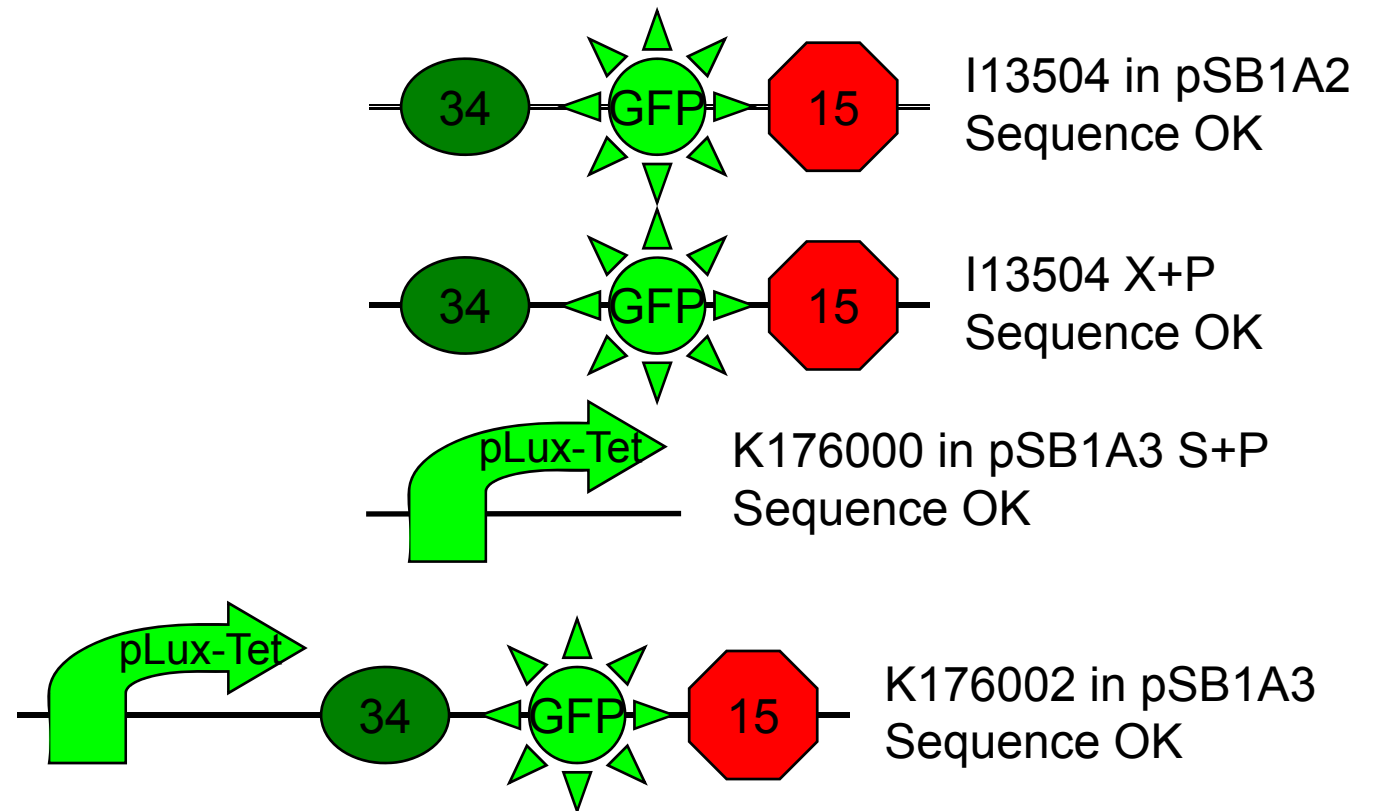

4



K145151 in pSB1A2 in DB3.1

Sequence OK

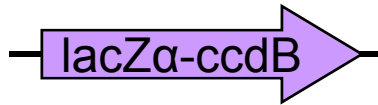

K176003 Fragment Length OK



B0034 in pSB1A2 Sequence OK



B0034 in pSB1A2 S+P Length OK

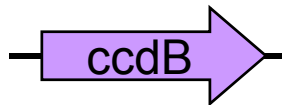

K145151 X+P Length OK

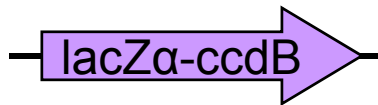

K176003 X+P Length OK

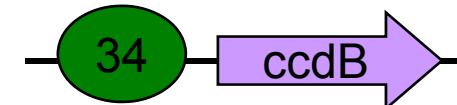

K176010 in pSB1A2 in DB3.1 Ligation

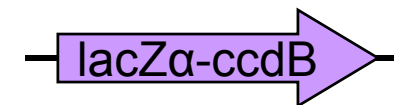

K176003 in pSB1A3 in DB3.1 Sequence OK

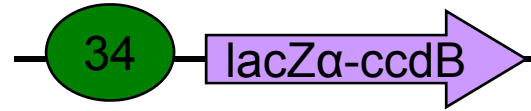

K176027 in pSB1A2 in DB3.1 Sequence OK

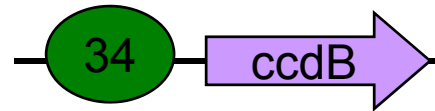

K176010 E+S Length OK

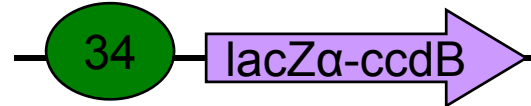

K176027 E+S Length OK

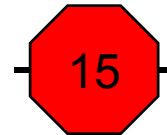

B0015 in pSB1AK3 Sequence OK



B0031 in pSB1A2 Length OK



B0031 S+P Length OK

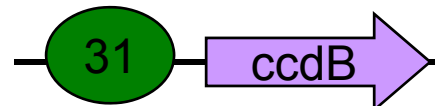

K176060 in pSB1A2 in DB3.1 Sequence OK

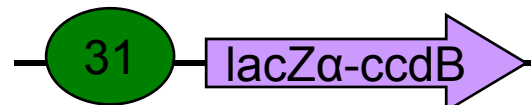

K176061 in pSB1A2 in DB3.1 Sequence OK

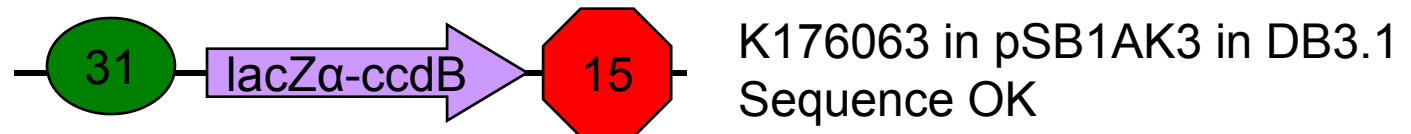
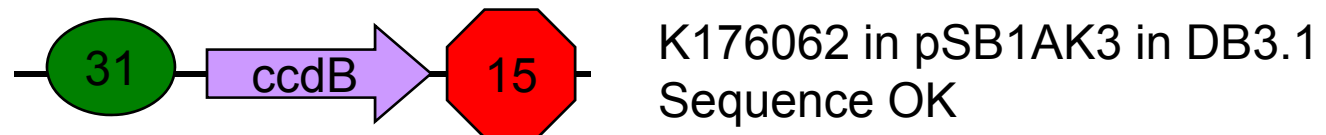
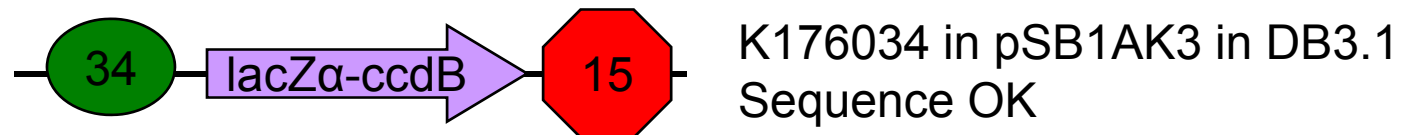
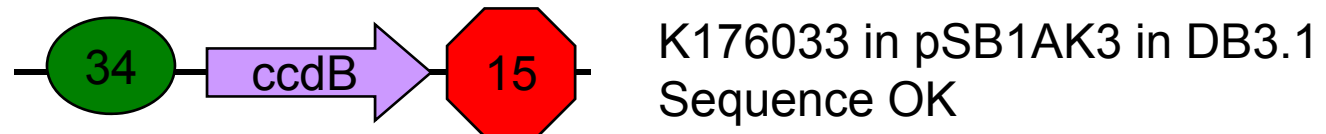
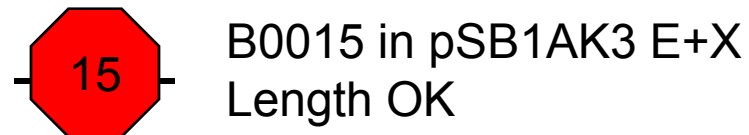
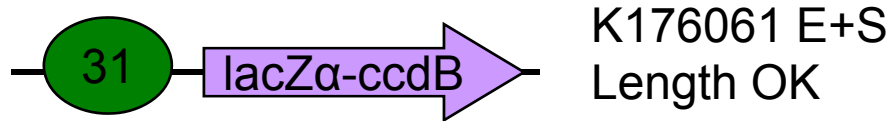
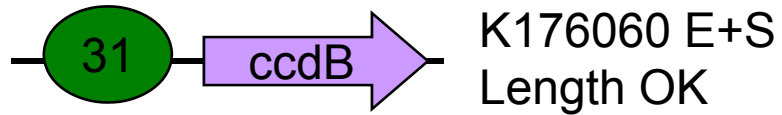

5

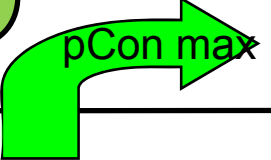
 pCon max  
J23119 in pSB1A2  
Sequence OK

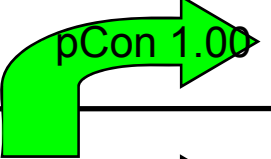
 pCon 1.00  
J23100 in J61002  
Sequence ?

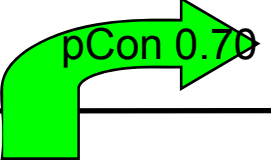
 pCon 0.70  
J23101 in J61002  
Sequence OK

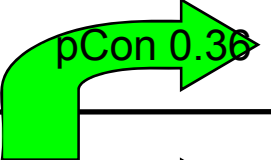
 pCon 0.36  
K176009 in J61002  
Sequence OK

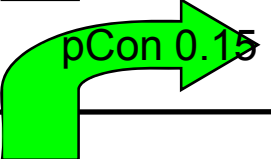
 pCon 0.15  
K176008 in J61002  
Sequence OK

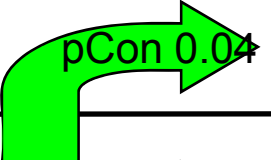
 pCon 0.04  
J23109 in J61002  
Sequence OK

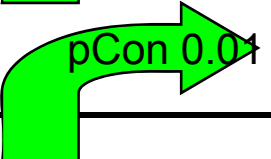
 pCon 0.04  
J23103 in J61002  
Sequence OK

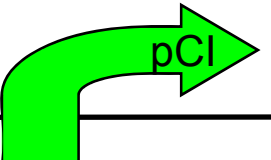
 pCl  
R0051 in pSB1A2  
Sequence OK

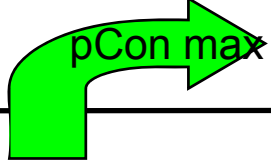
 pCon max  
J23119 X+P  
Sequence OK

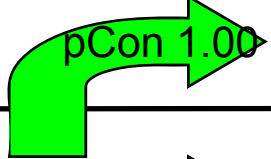
 pCon 1.00  
J23100-J61002SF X+P  
Sequence ?

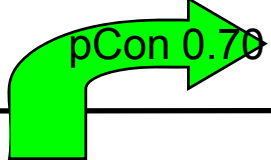
 pCon 0.70  
J23101-J61002SF X+P  
Sequence OK

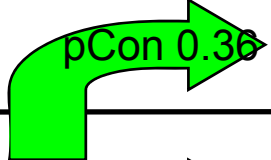
 pCon 0.36  
K176009-J61002SF X+P  
Sequence OK

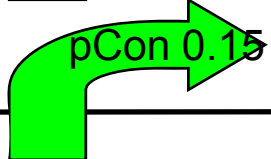
 pCon 0.15  
K176008-J61002SF X+P  
Sequence OK

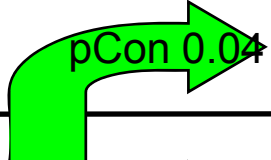
 pCon 0.04  
J23109-J61002SF X+P  
Sequence OK

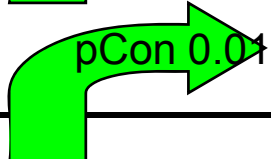
 pCon 0.04  
J23103-J61002SF X+P  
Sequence OK

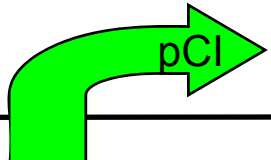
 pCl  
R0051 X+P  
Length OK

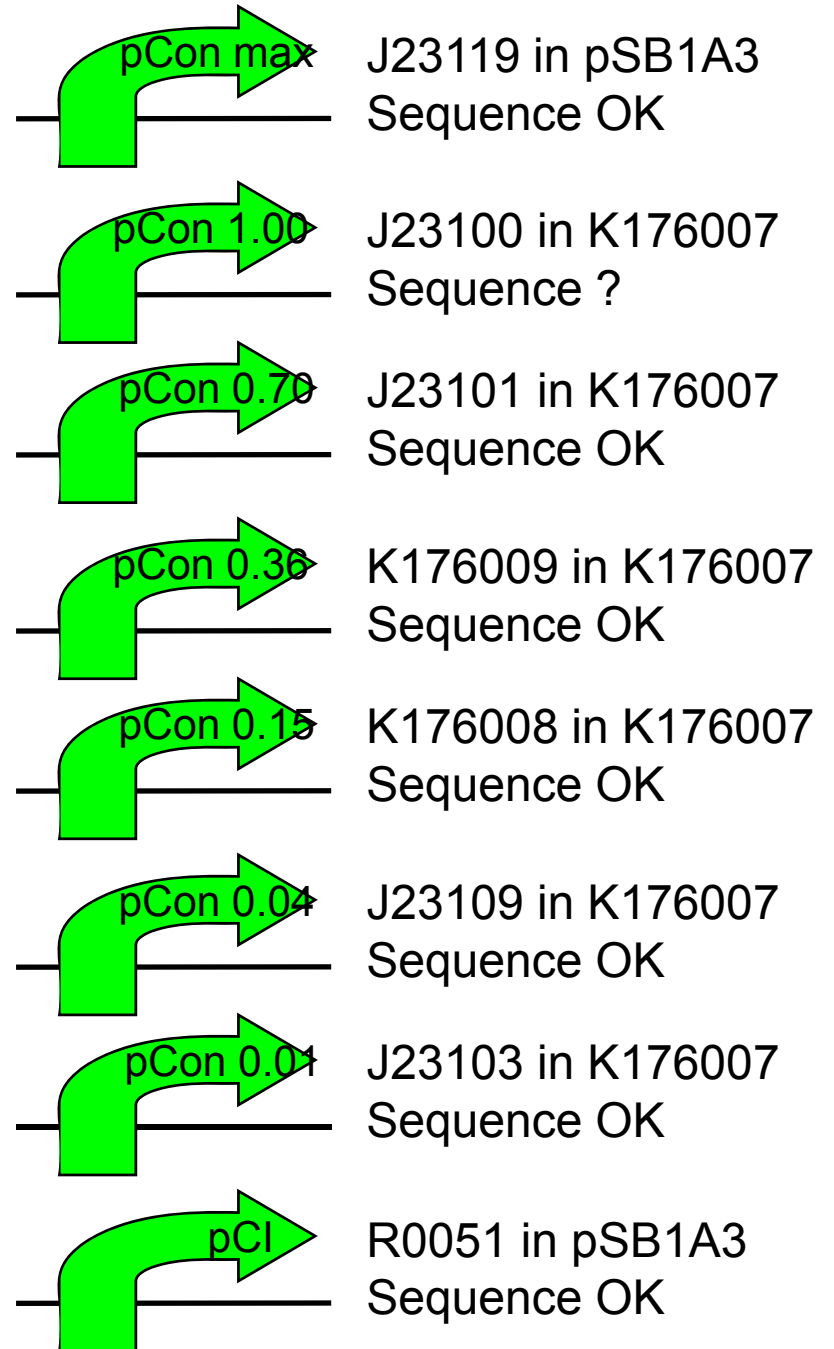

6

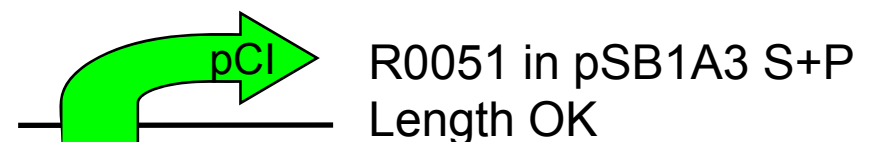
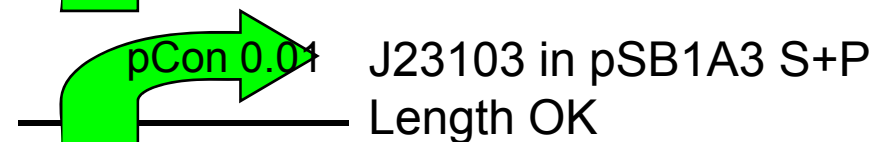
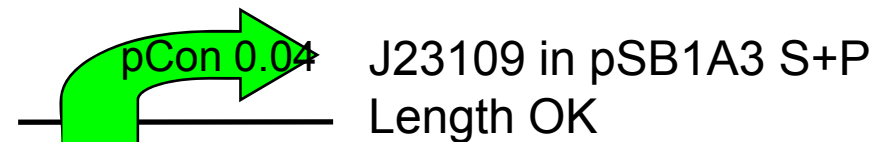
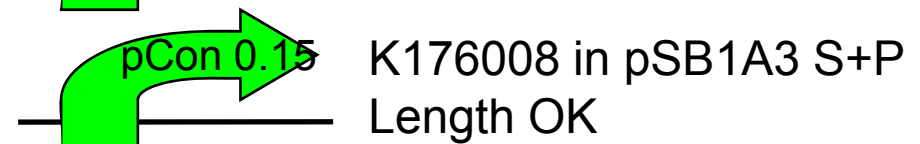
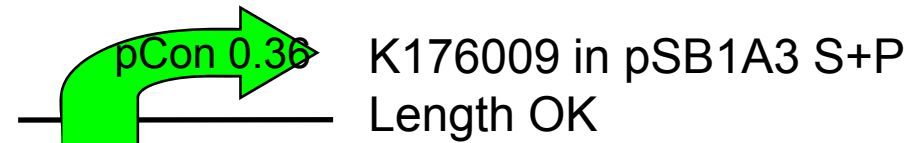
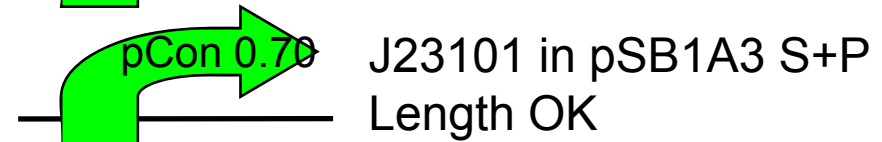
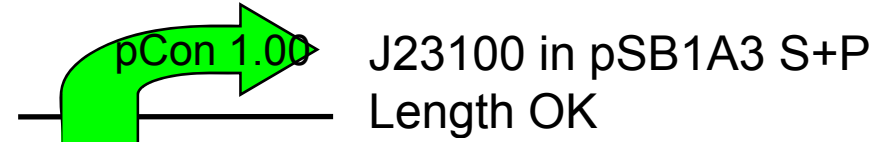
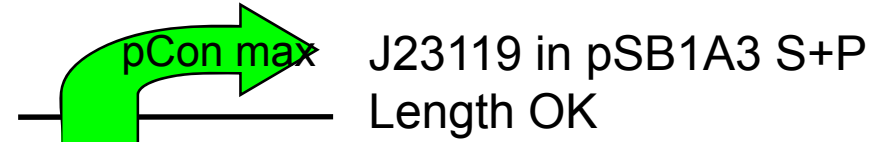
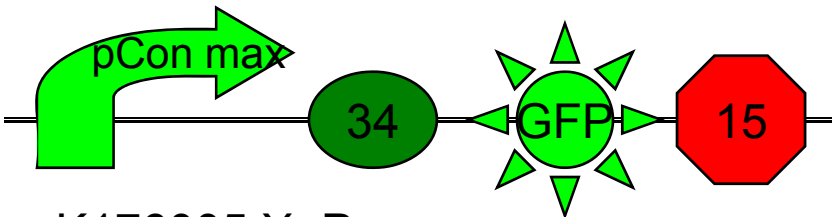
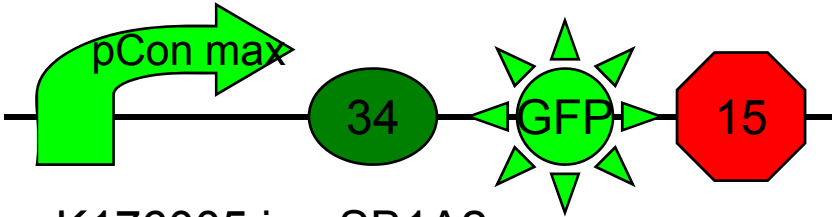
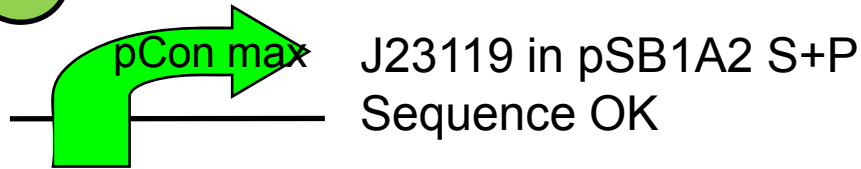

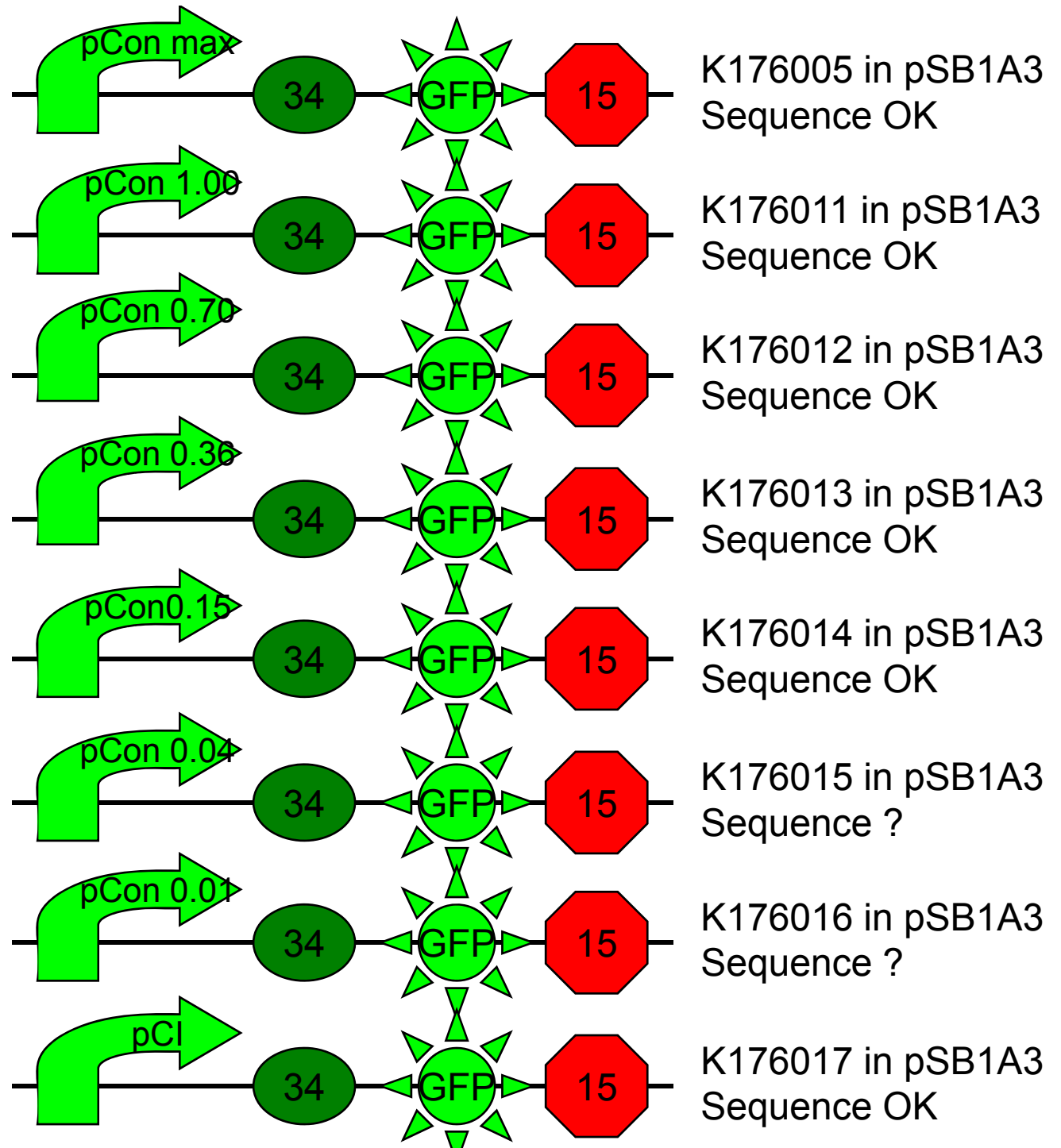

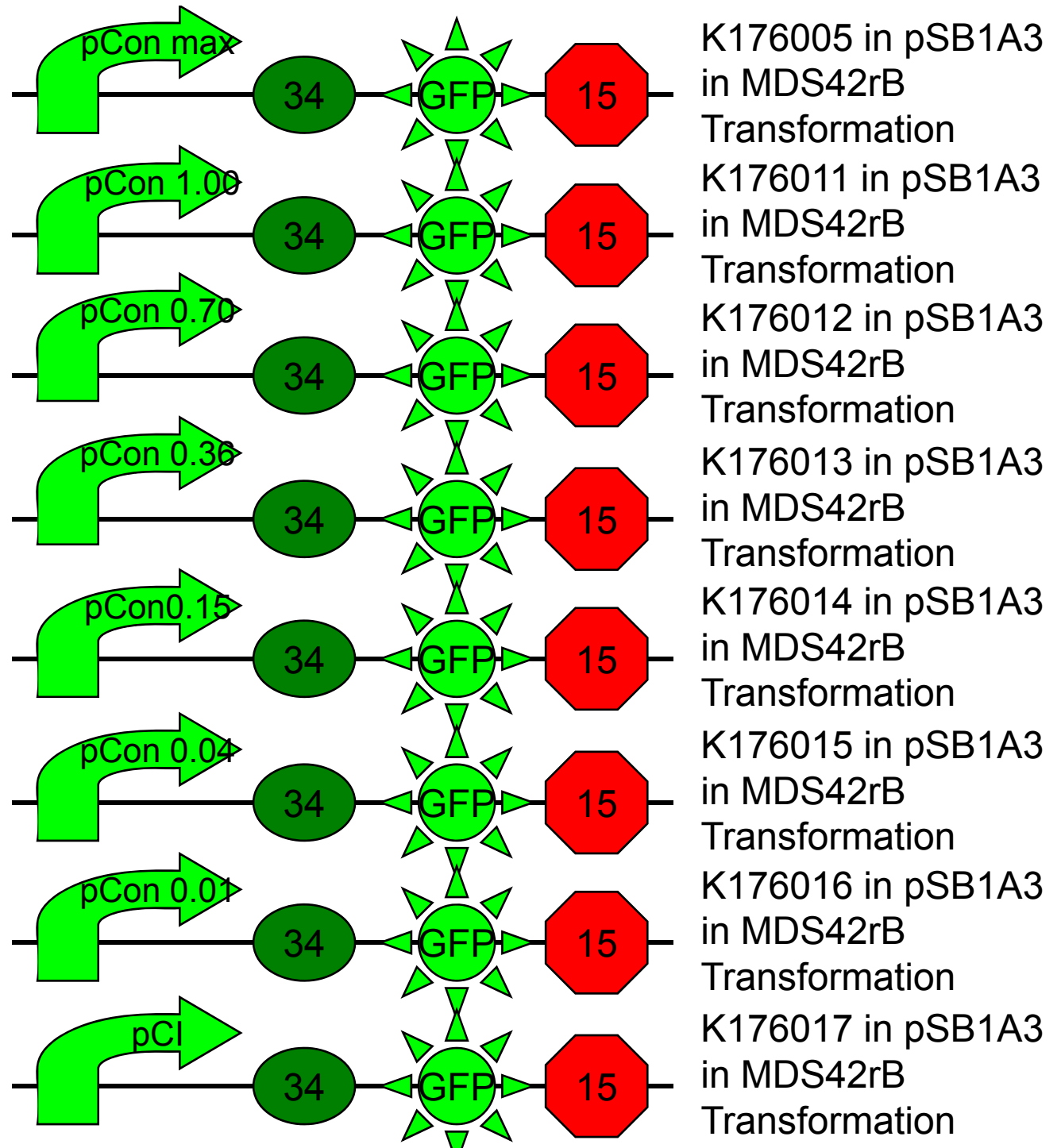



# Flu:OD

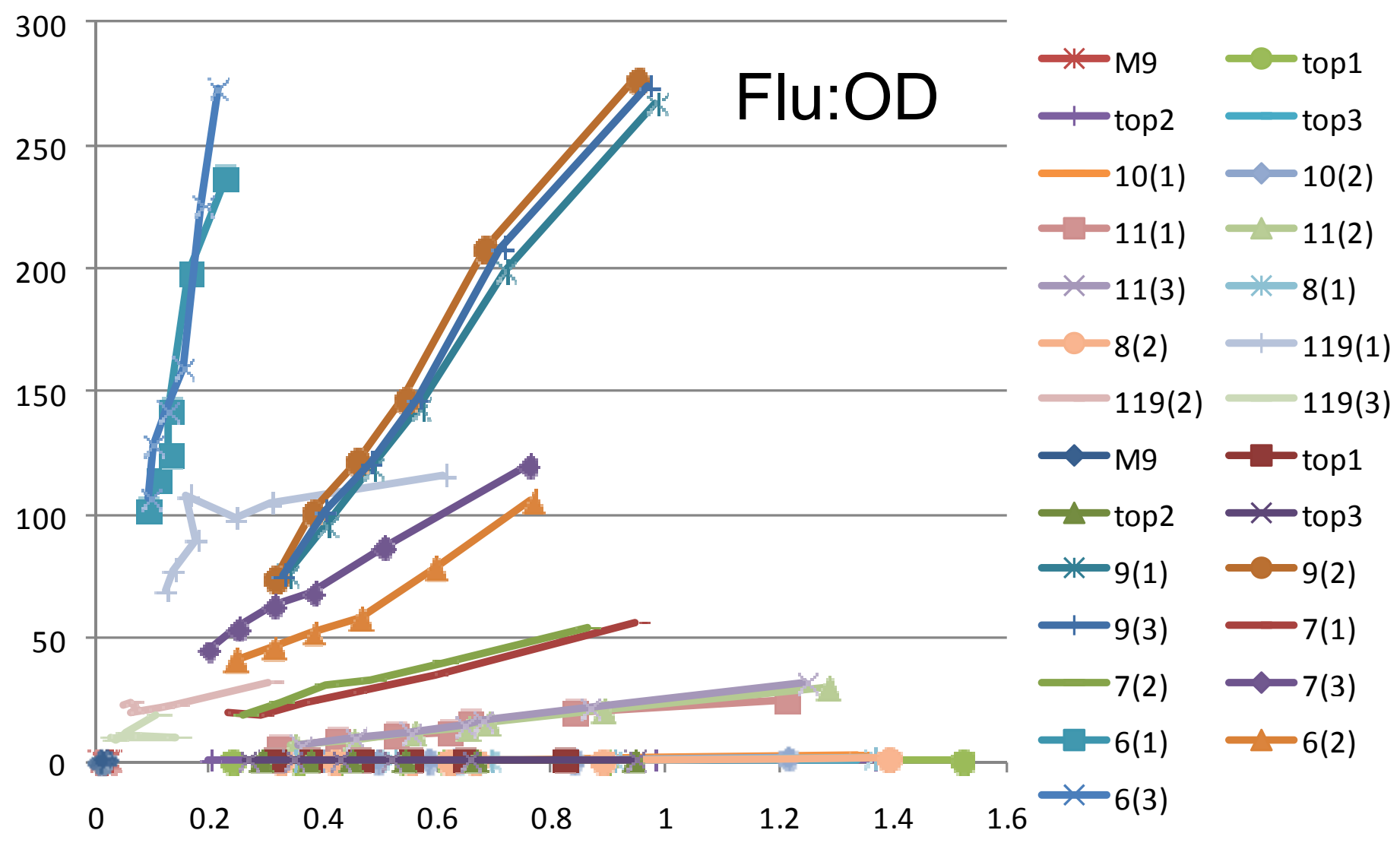

# Flu:OD

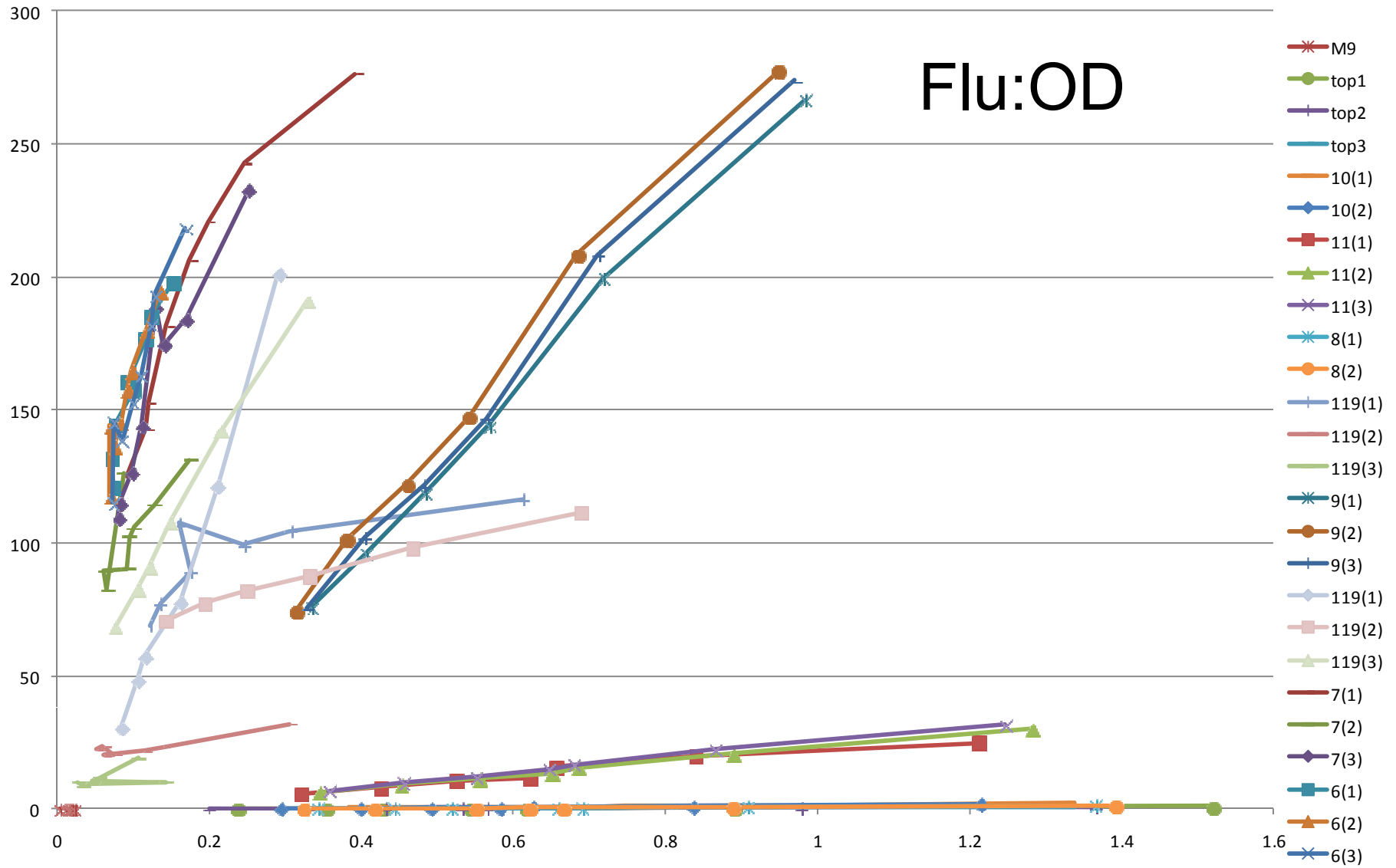



7

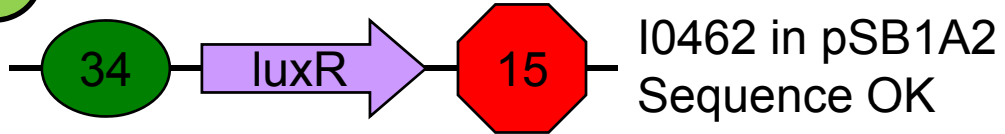

I0462 in pSB1A2  
Sequence OK

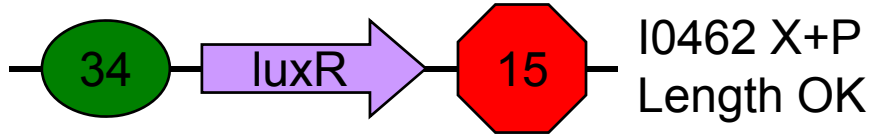

I0462 X+P  
Length OK

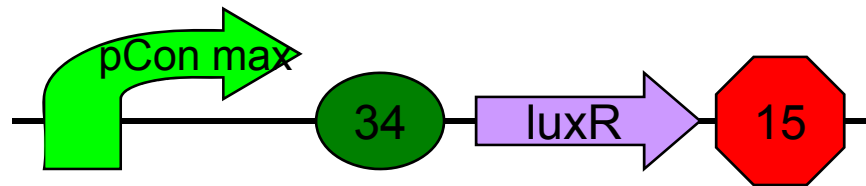

K176004 in pSB1A2  
Sequence OK  
Length ?

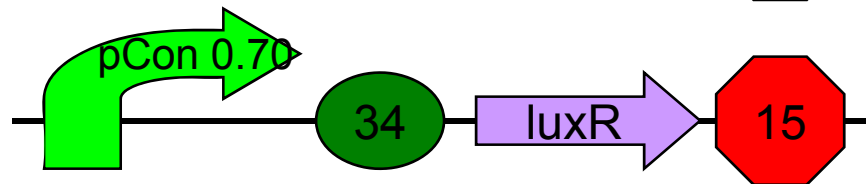

K176025 in pSB1A3  
Sequence ?

8

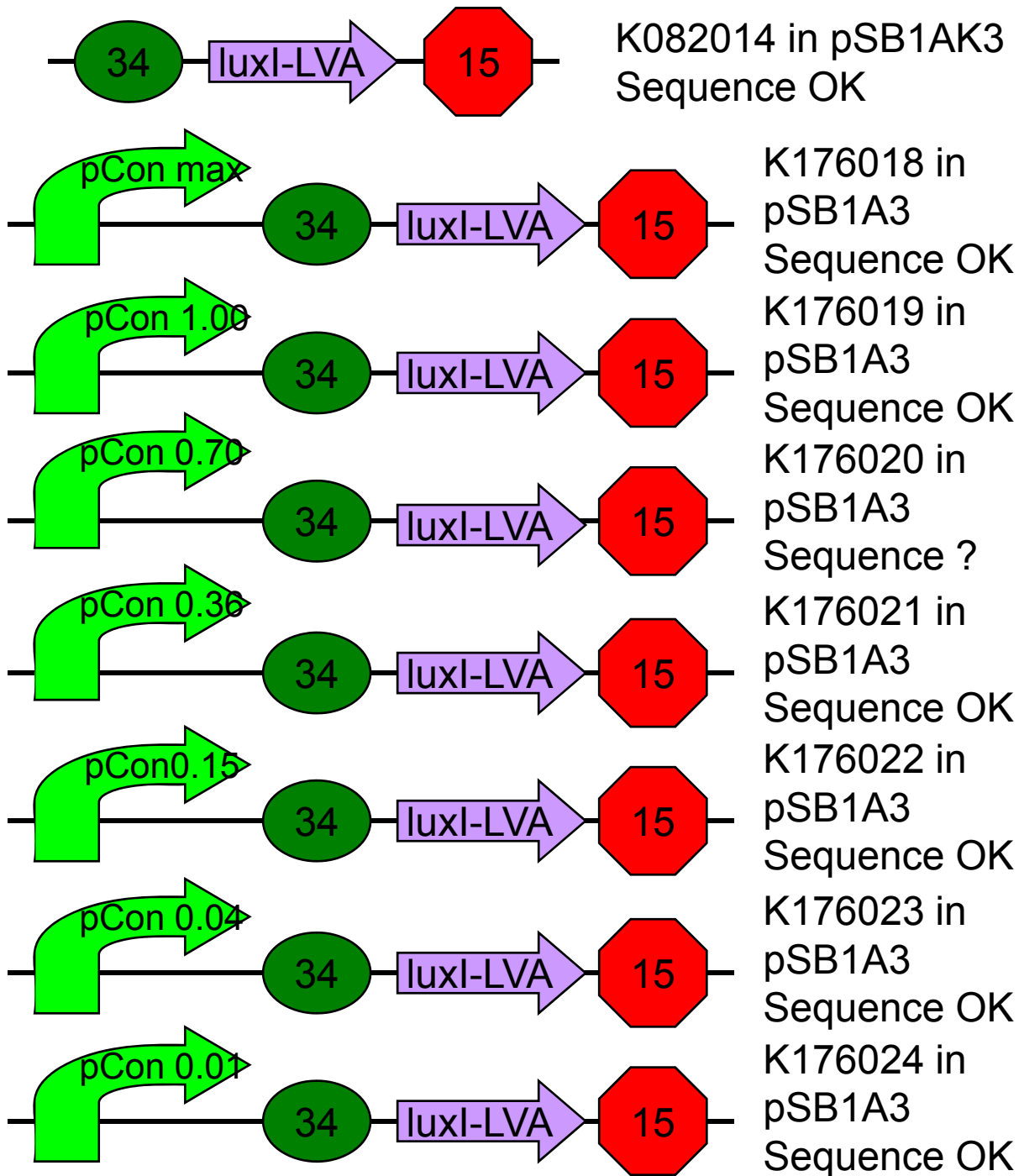

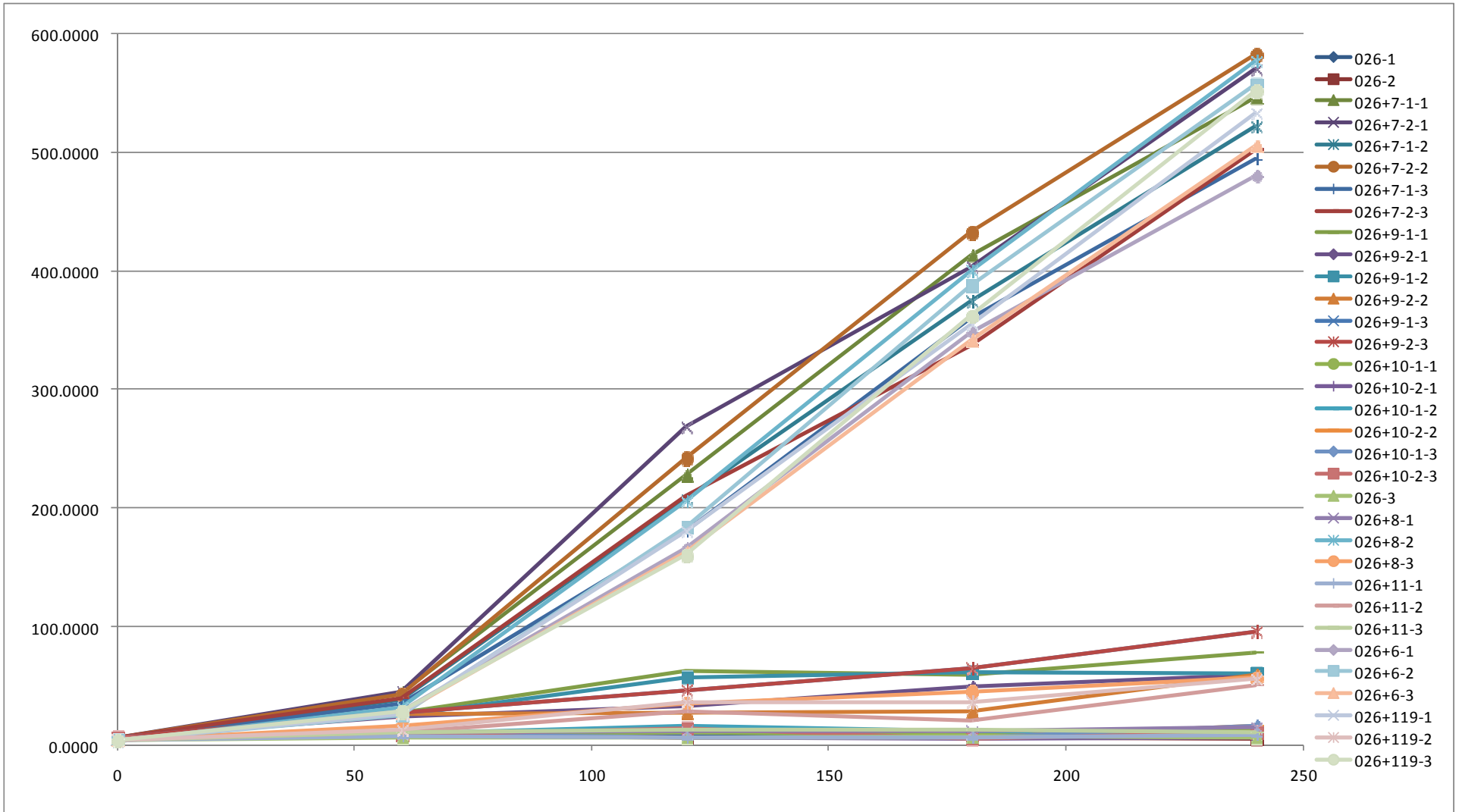

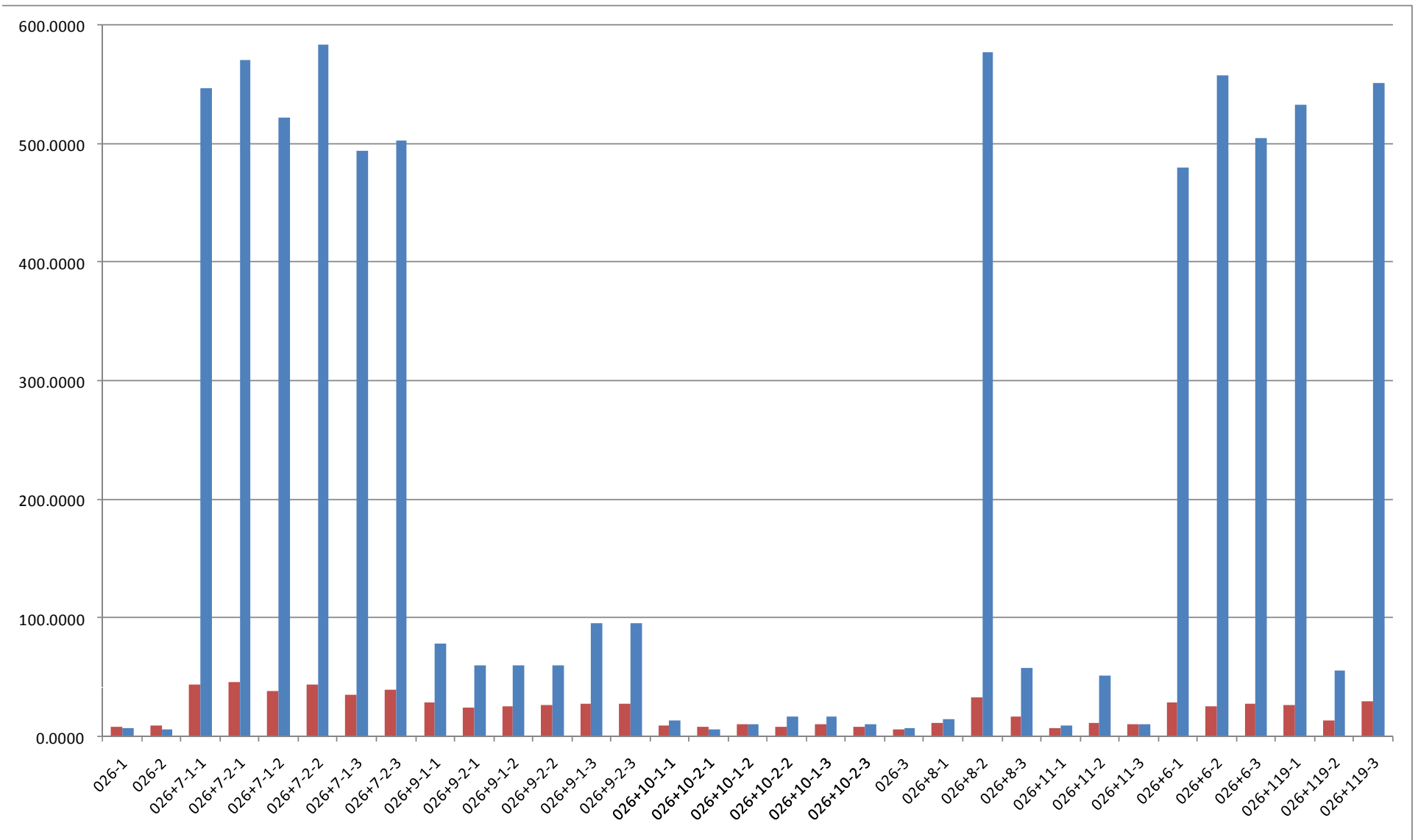

3

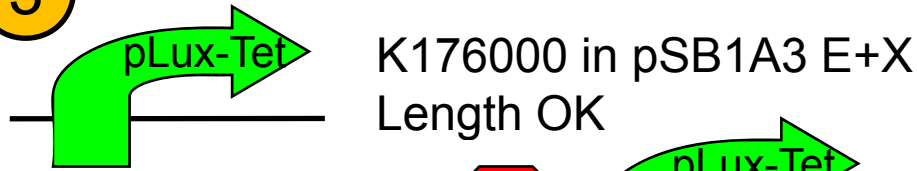

K176000 in pSB1A3 E+X  
Length OK

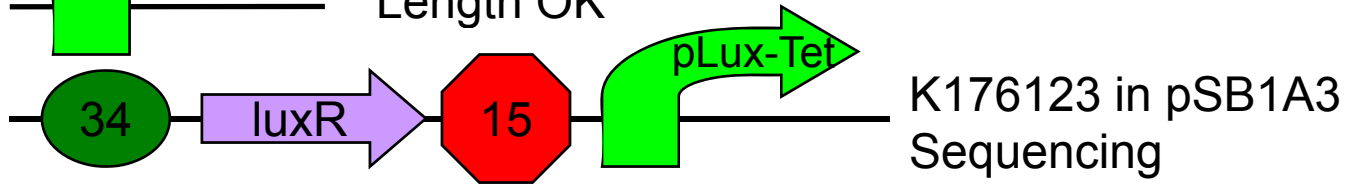

K176123 in pSB1A3  
Sequencing

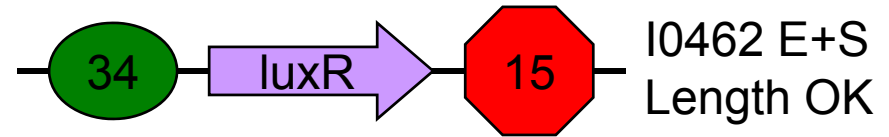

I0462 E+S  
Length OK

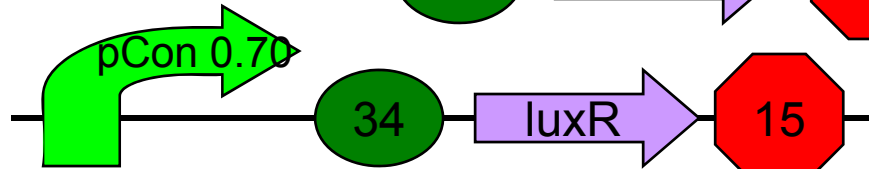

K176025 E+S  
Length OK

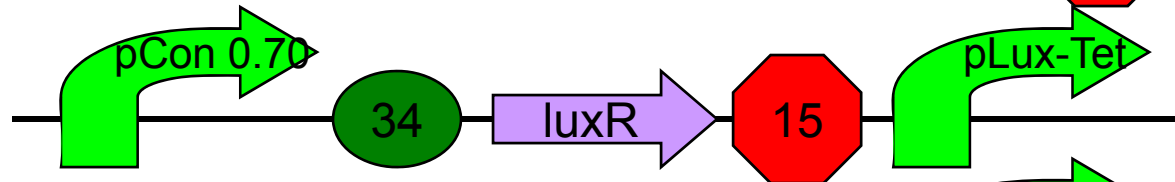

K176028 in pSB1A3  
Sequence ?

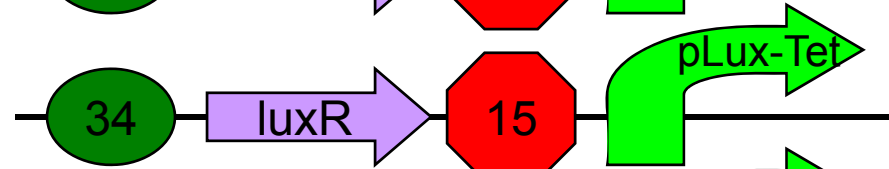

K176123 X+P  
Length OK

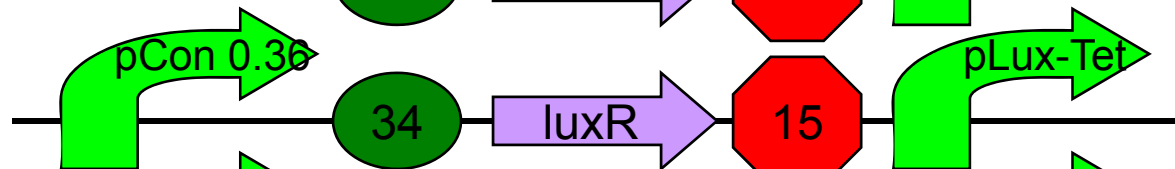

K176125 in pSB1A3  
Sequencing

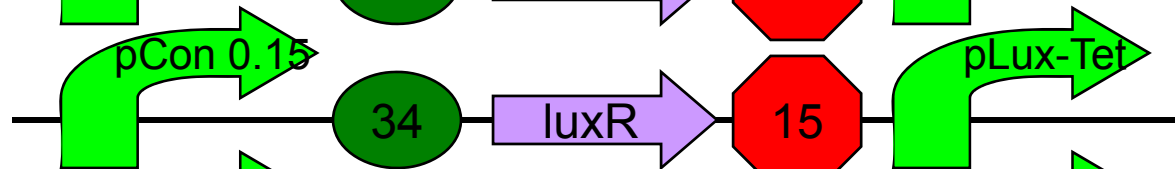

K176127 in pSB1A3  
Sequencing

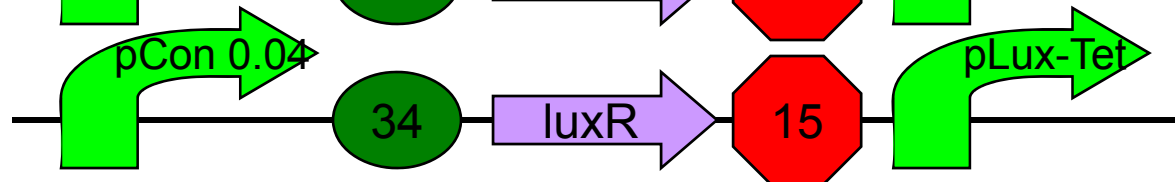

K176129 in pSB1A3  
Ligation



9

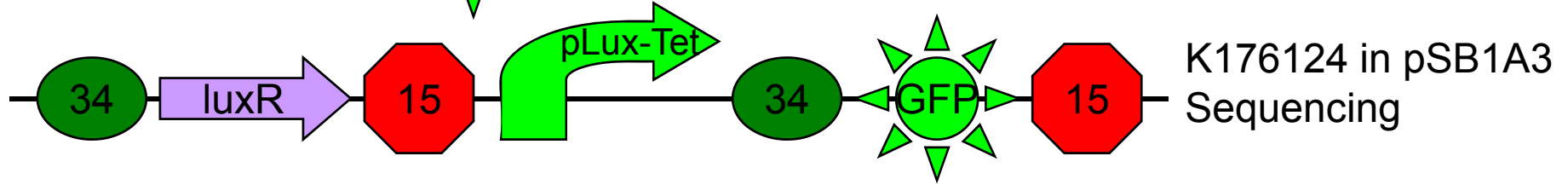
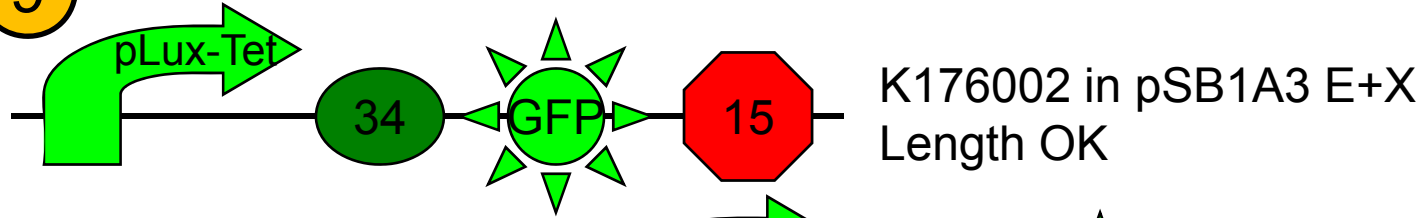

VRGFP ←  
G00201  
Synthesis OK

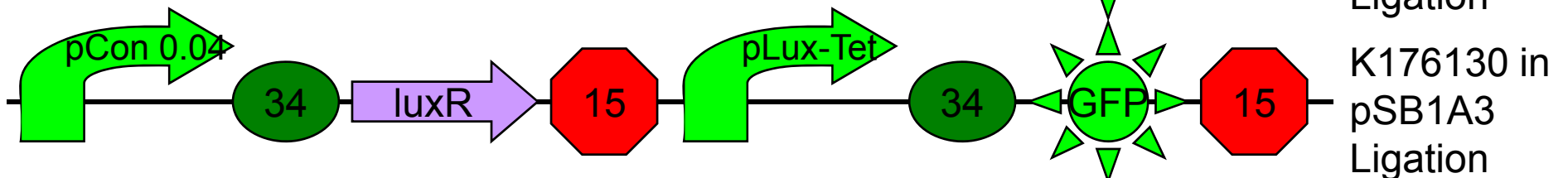
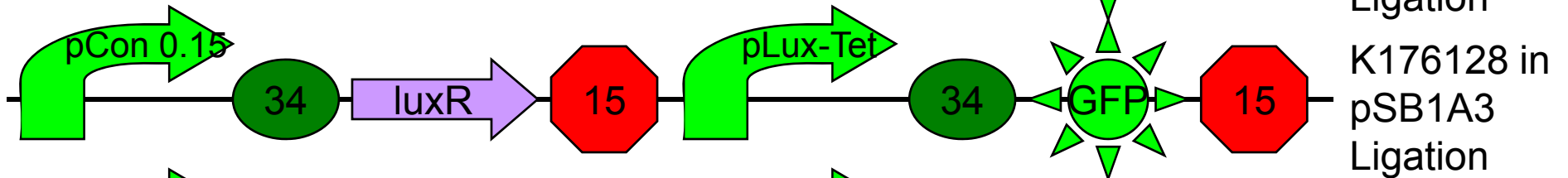
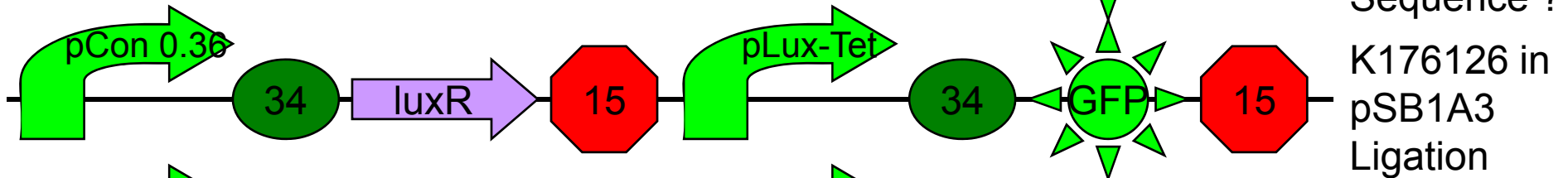
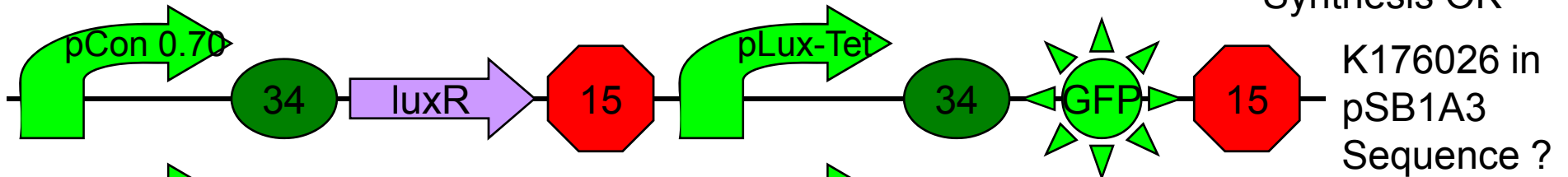

# Methods

- Plate Reader
- Spectrophotometer



# Flu/OD:t(min)

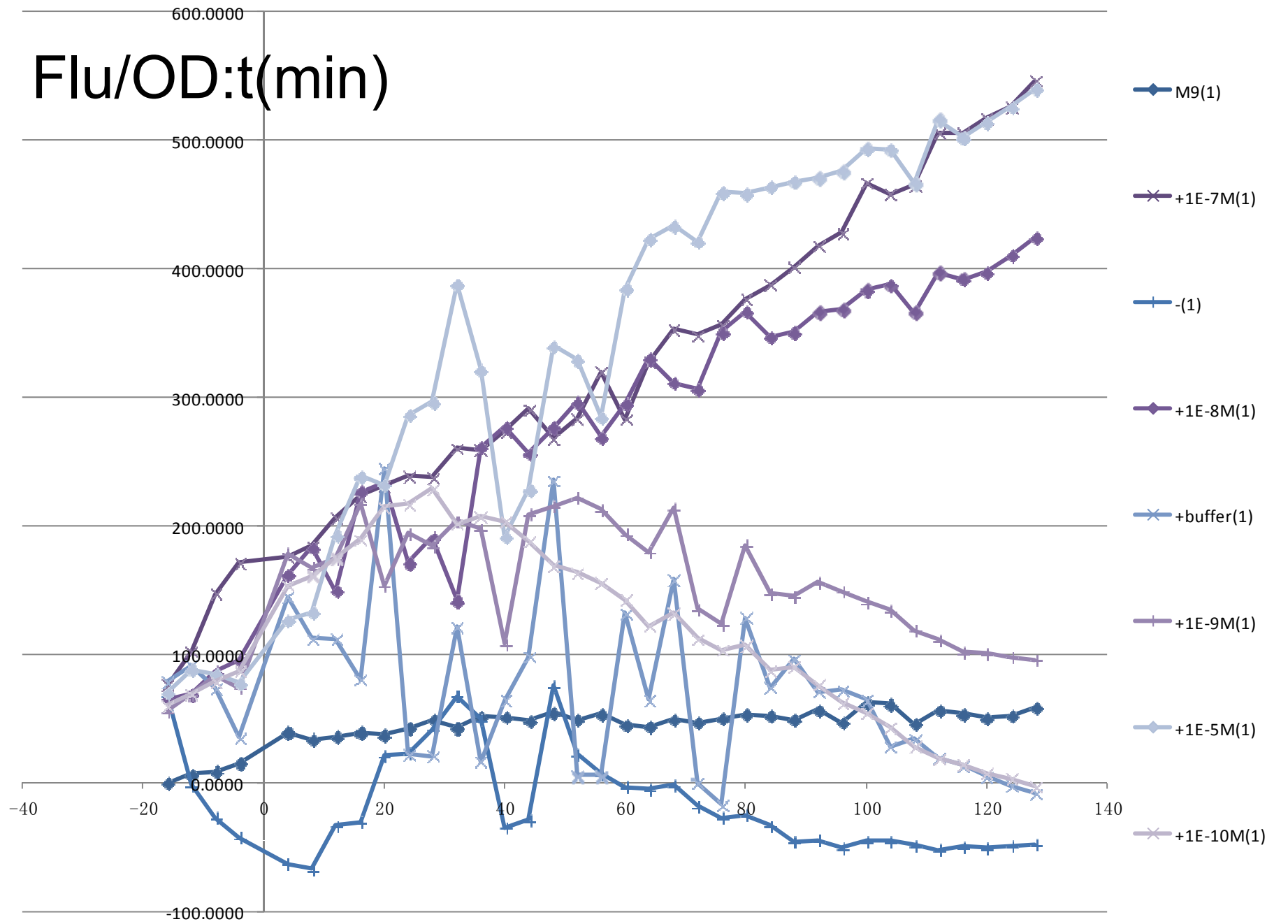

# Flu/OD:t(min)

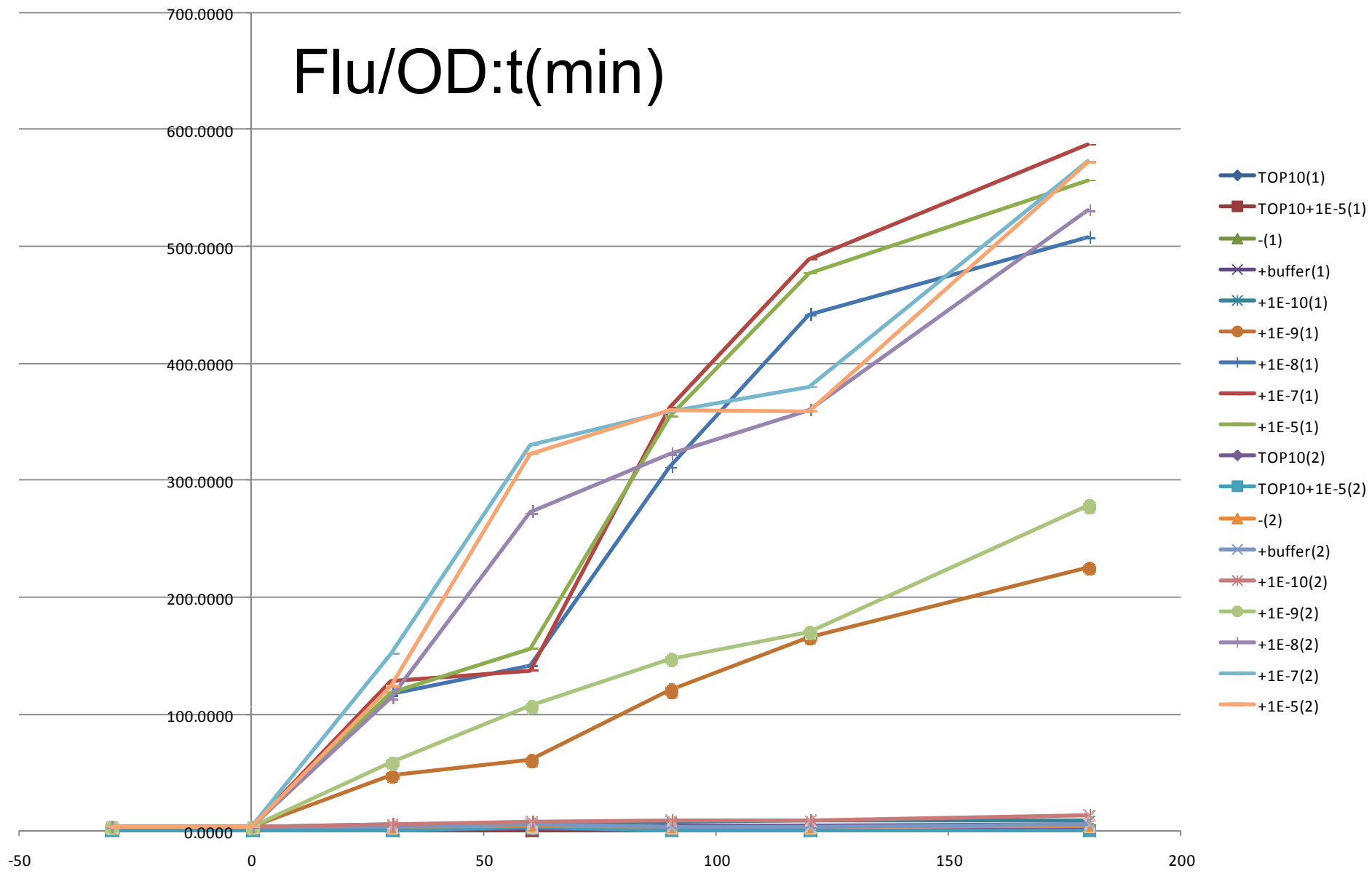

# Flu/OD:t(min)

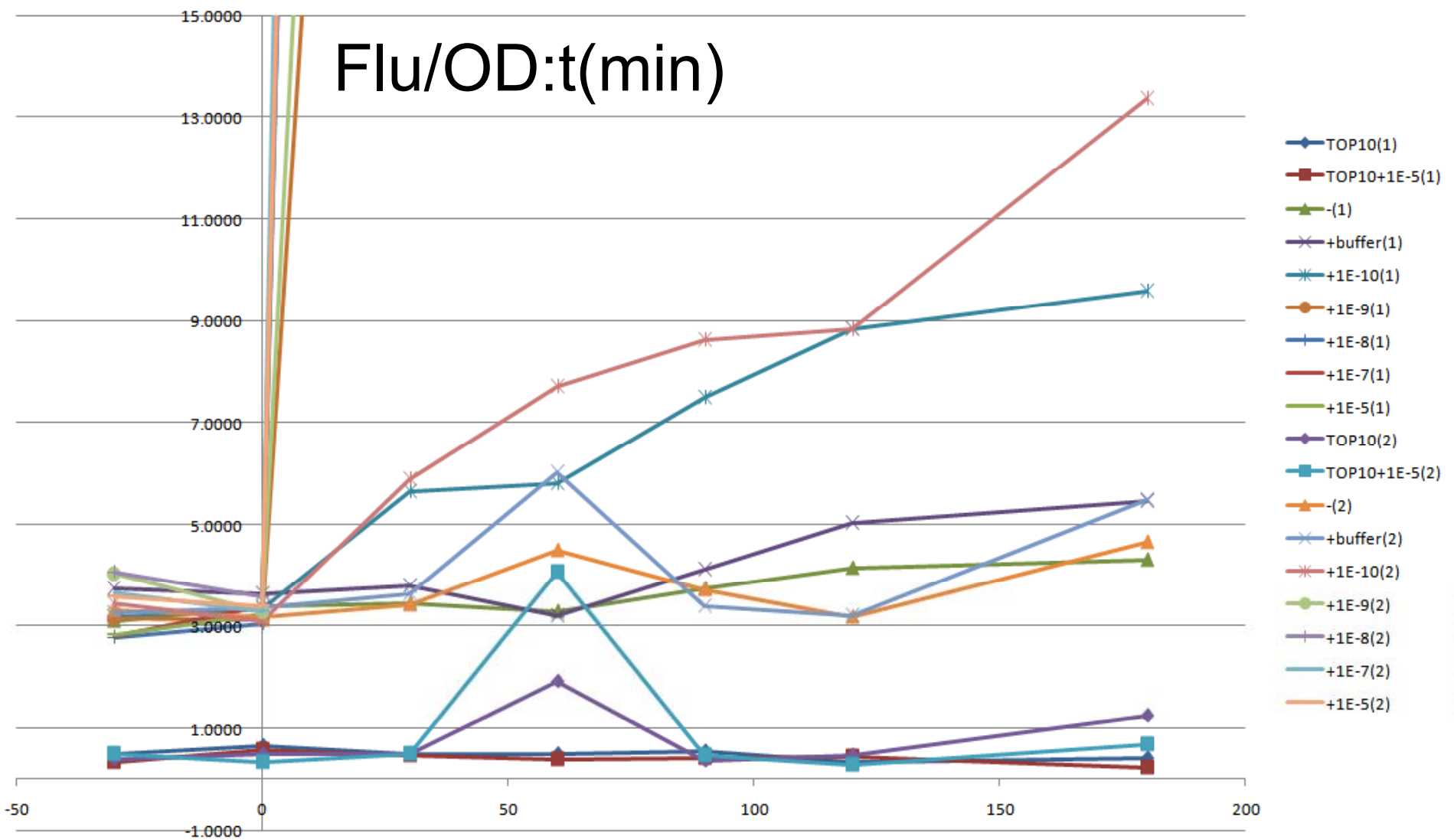

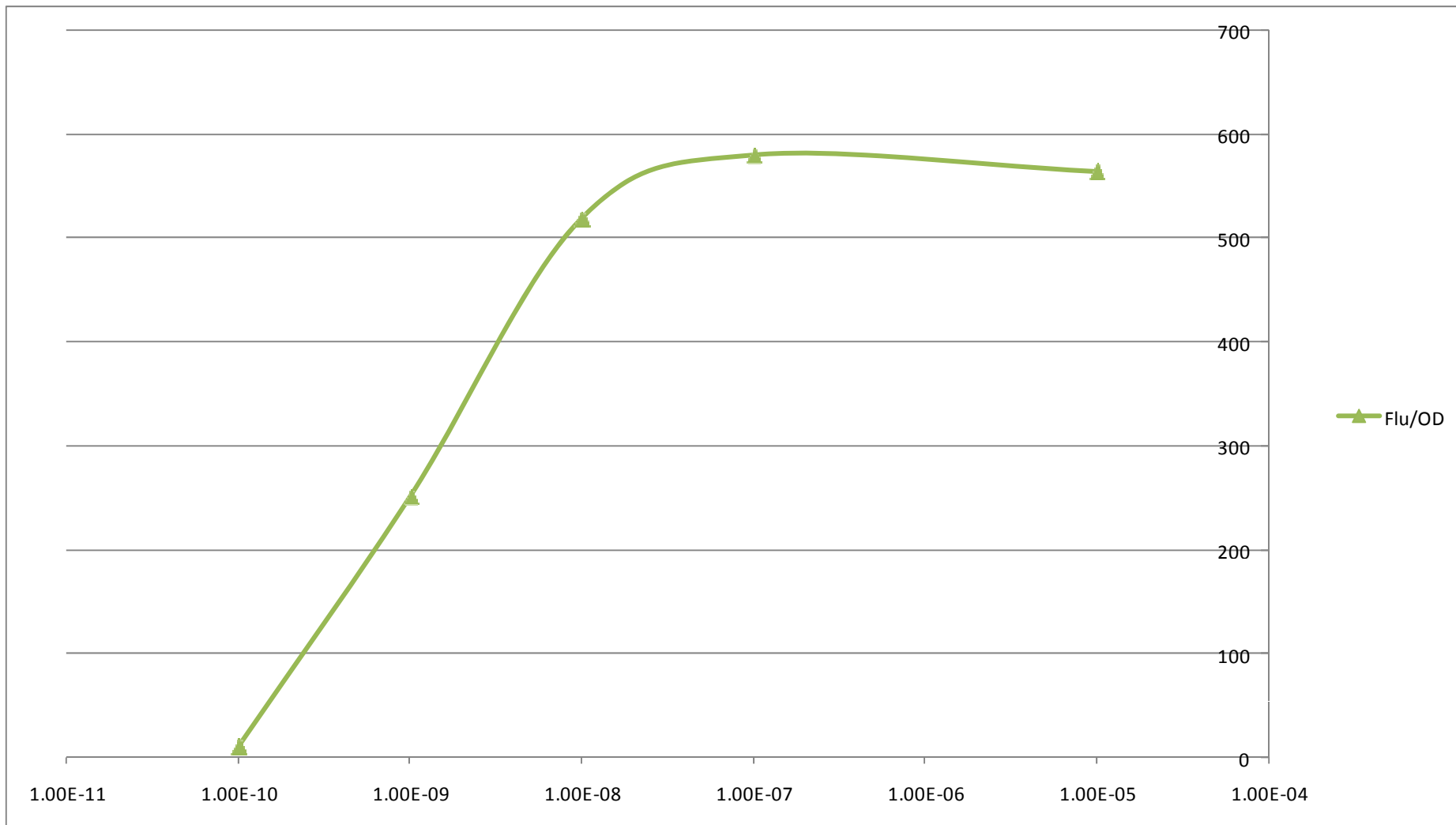

# F2620

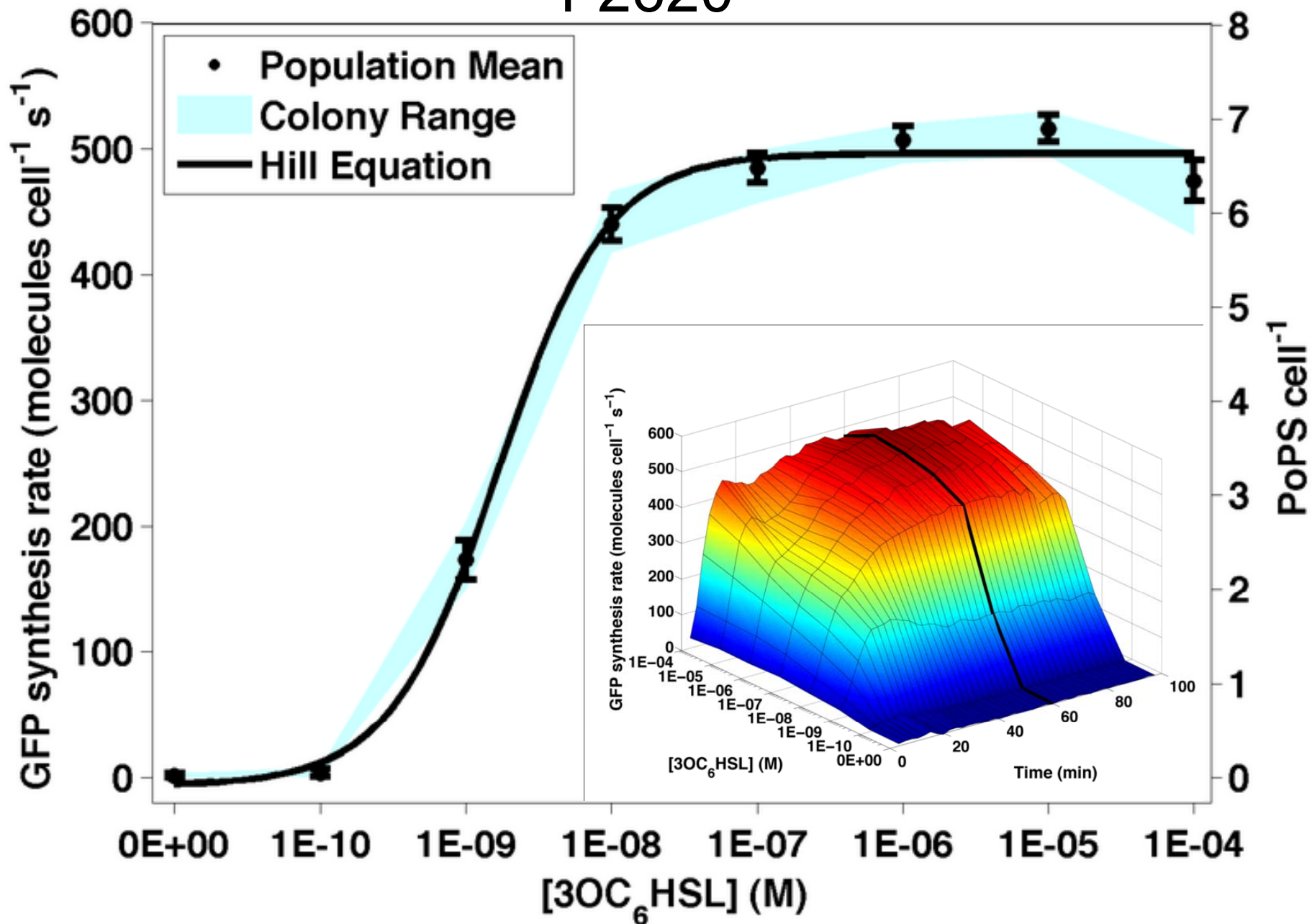



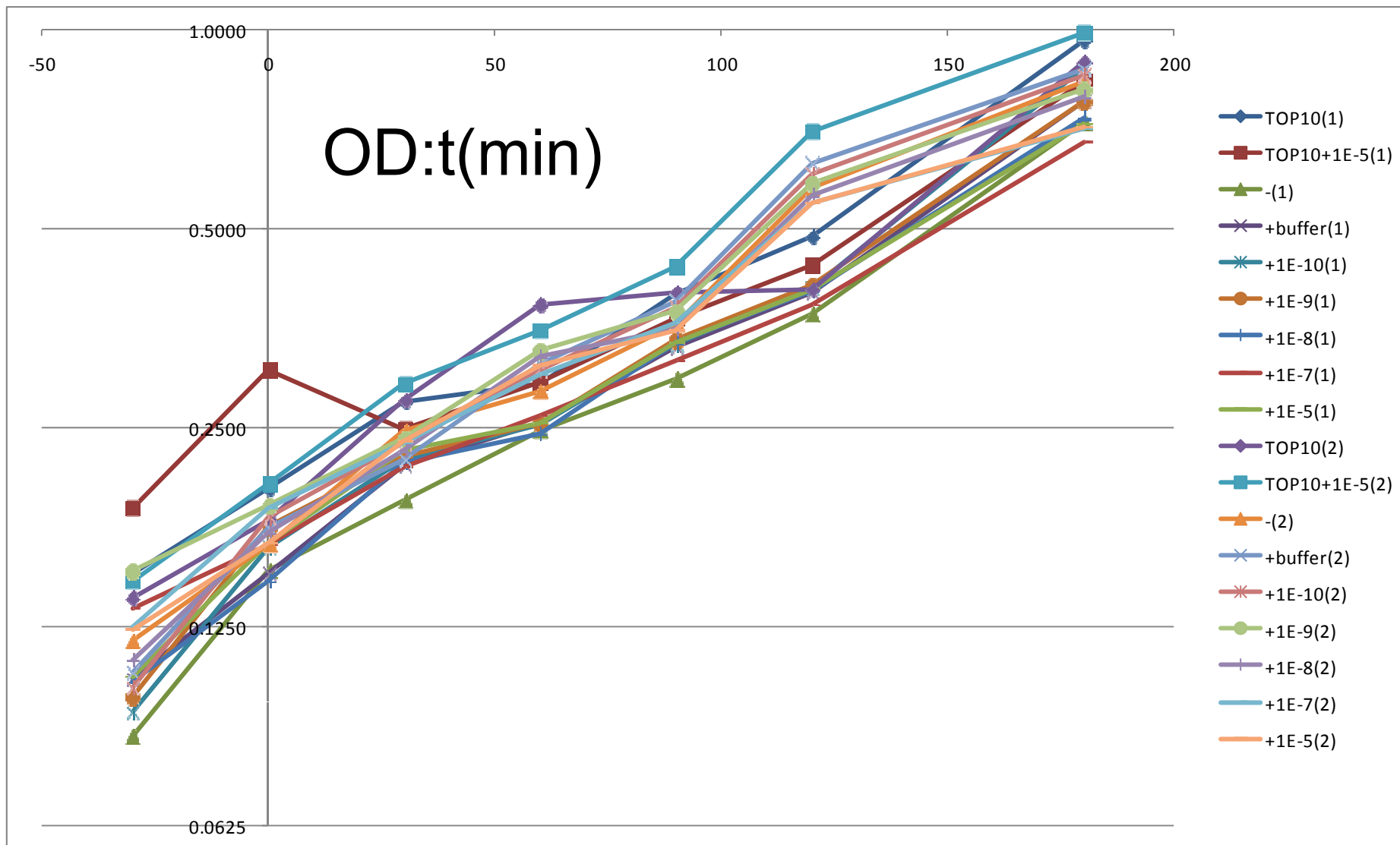

OD:t(min)

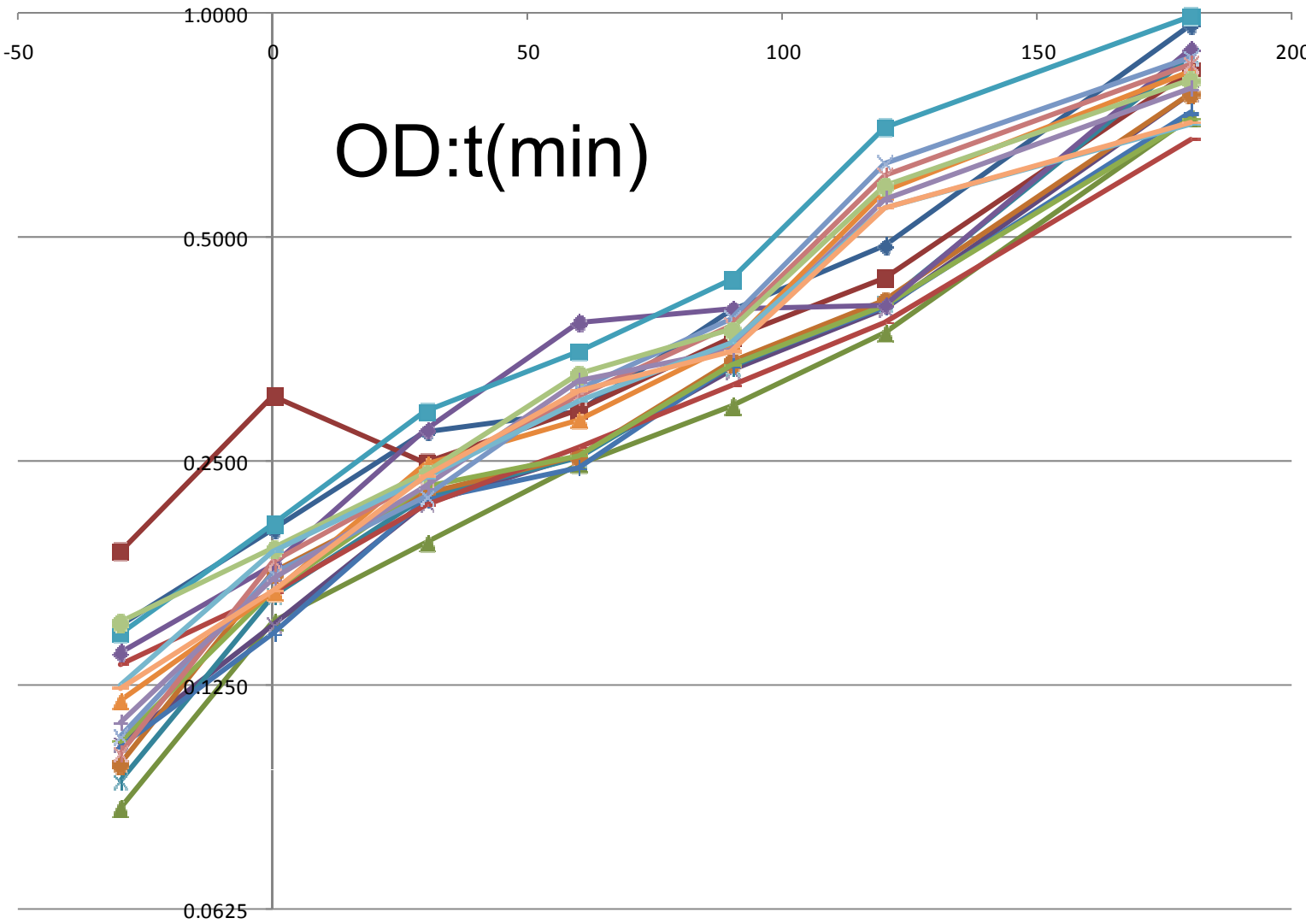

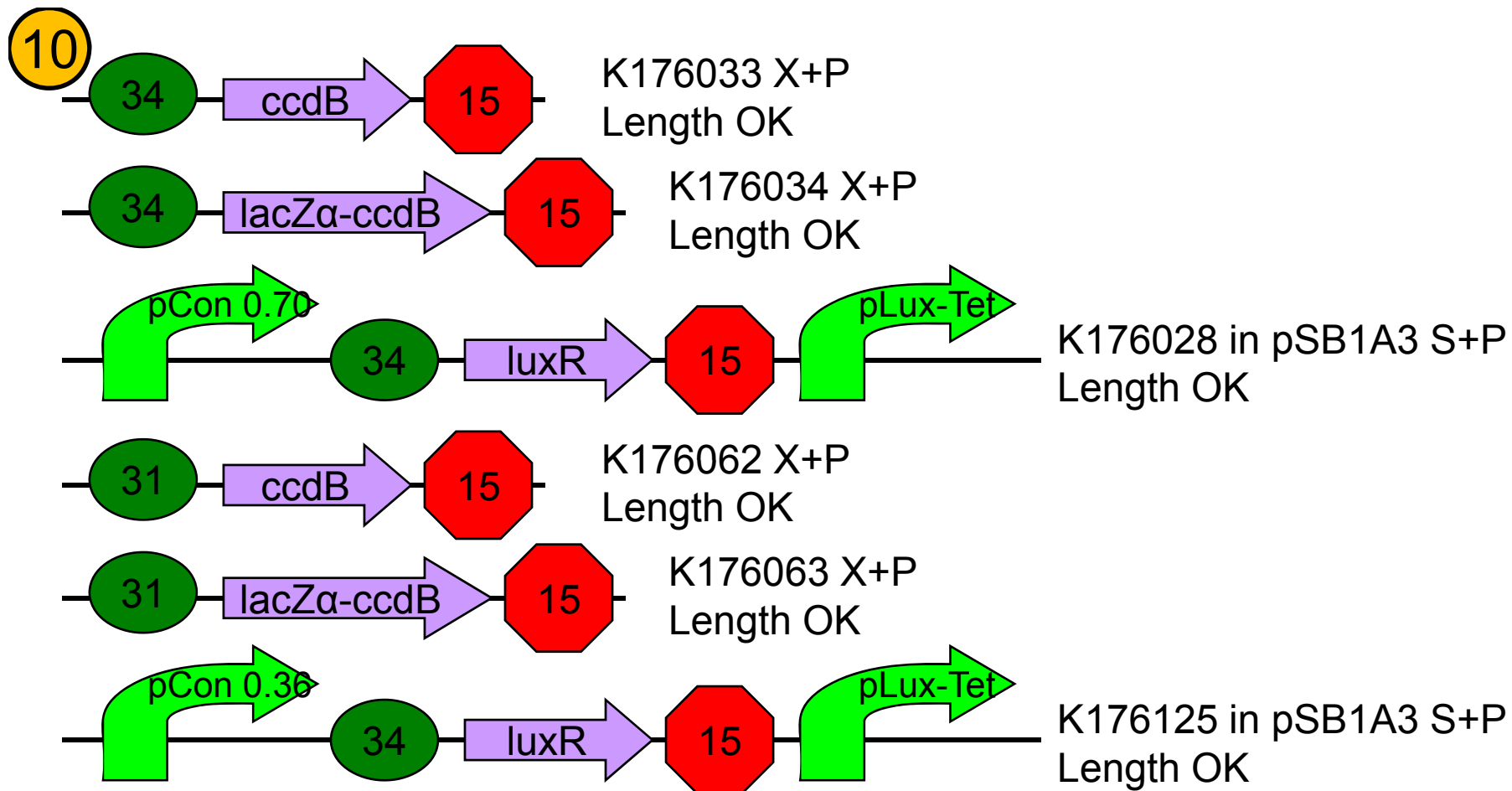

← VRccdB K176058  
Synthesis OK

← M13-47 K176059  
Synthesis OK

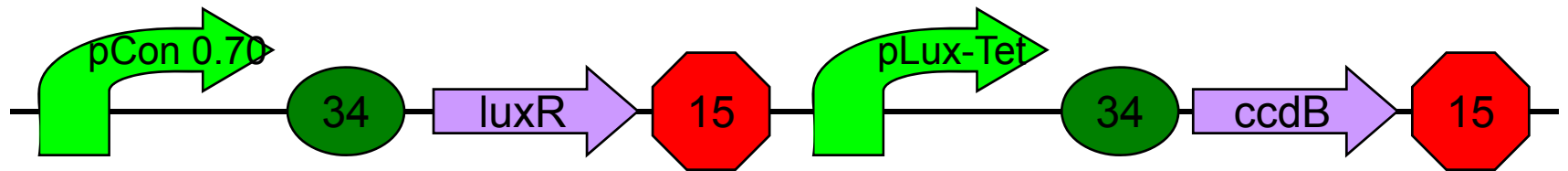

K176035 in pSB1A3 in DB3.1  
Sequence ?

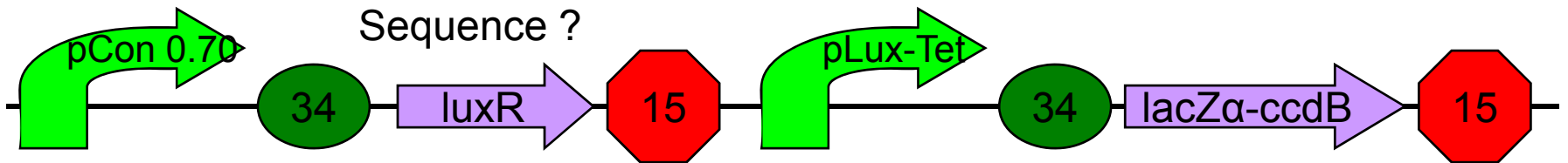

K176036 in pSB1A3 in DB3.1  
Sequence OK

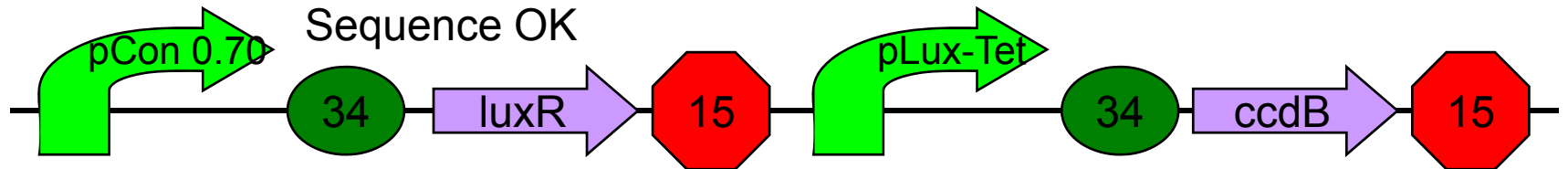

K176035 in pSB1A3 in TOP10  
Transformation Fail

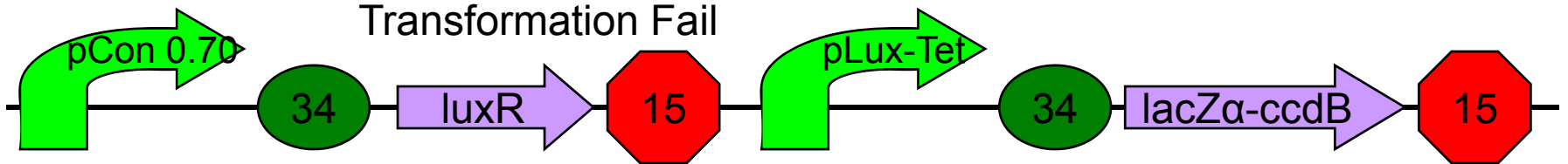

K176036 in pSB1A3 in TOP10  
Transformation Fail

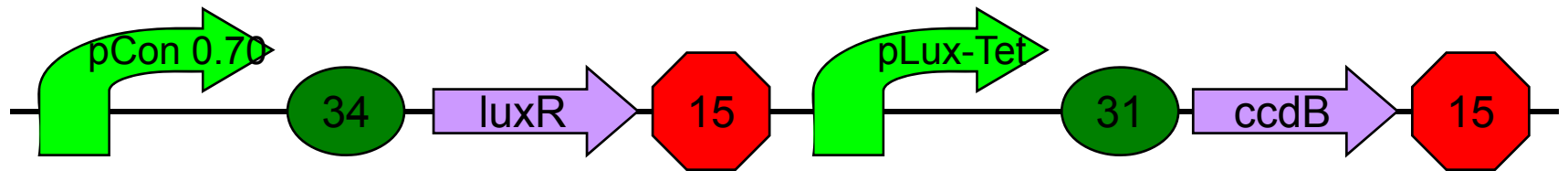

K176089 in pSB1A3 in DB3.1

Sequencing

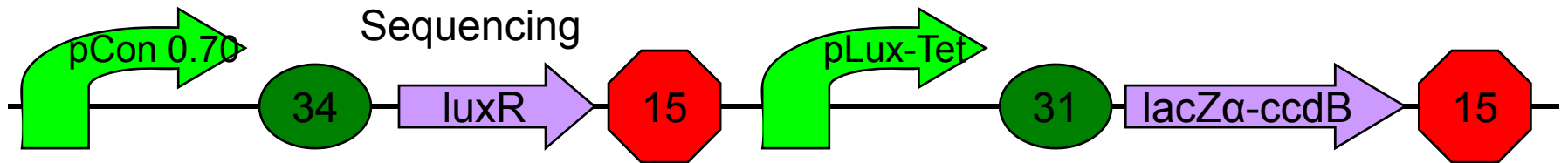

K176090 in pSB1A3 in DB3.1

Sequence ?

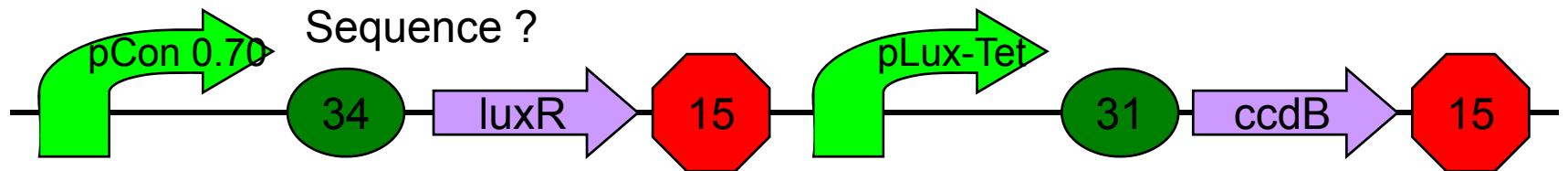

K176089 in pSB1A3 in TOP10

Transformation

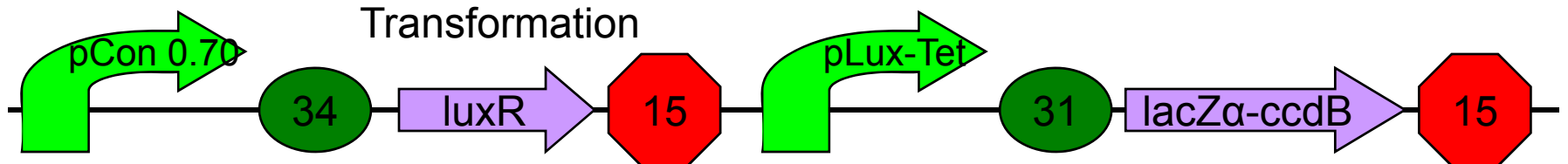

K176090 in pSB1A3 in TOP10

Transformation

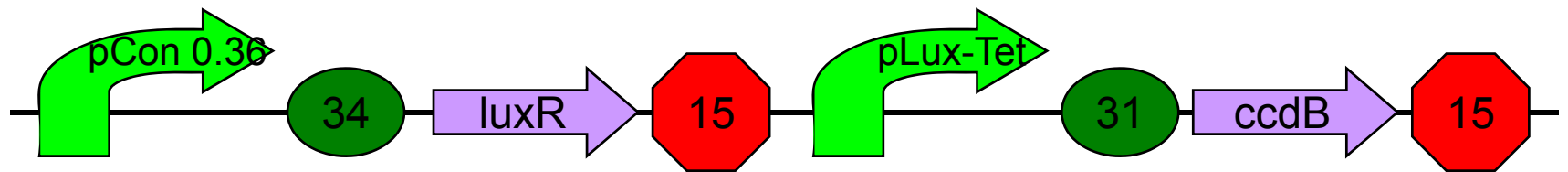

K176131 in pSB1A3 in DB3.1

Ligation

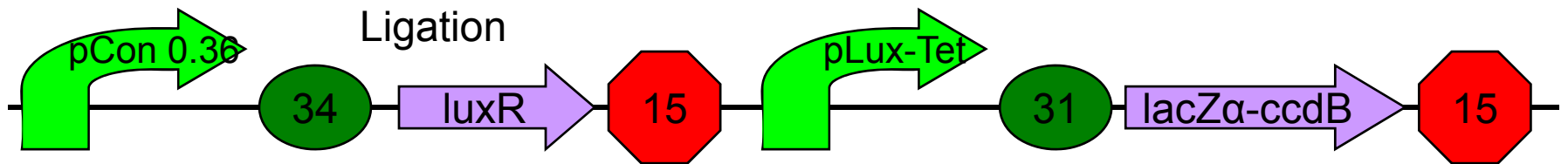

K176132 in pSB1A3 in DB3.1

Ligation

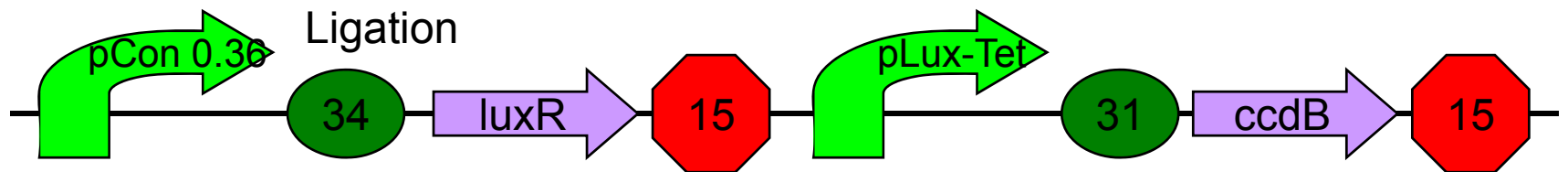

K176131 in pSB1A3 in TOP10

Waiting

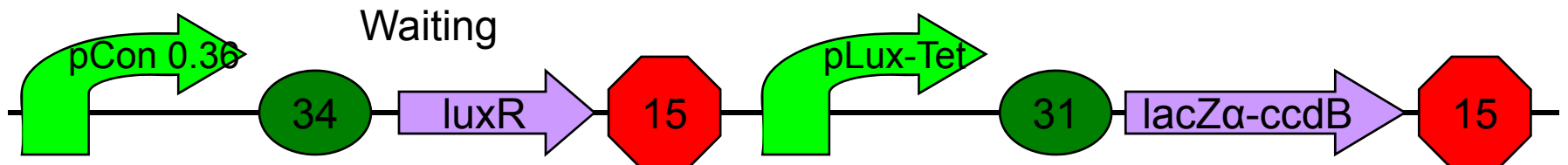

K176132 in pSB1A3 in TOP10

Waiting

11

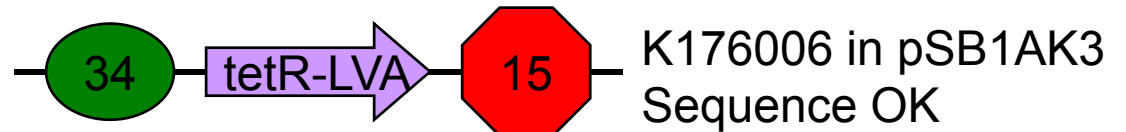
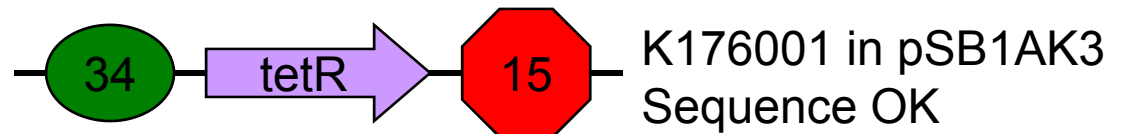
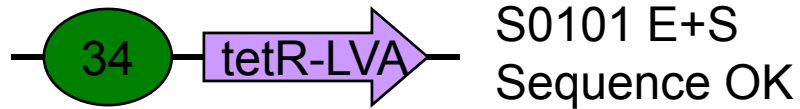
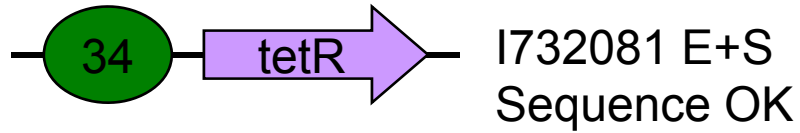
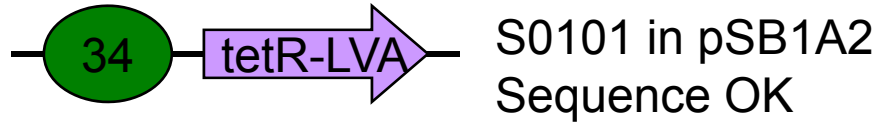
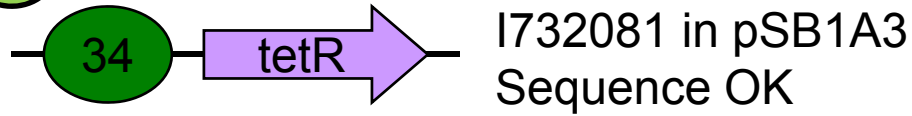

12

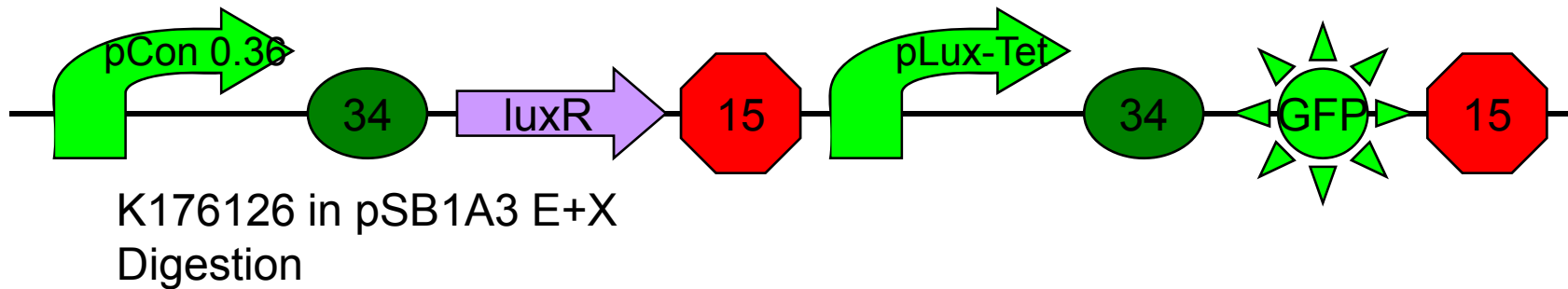
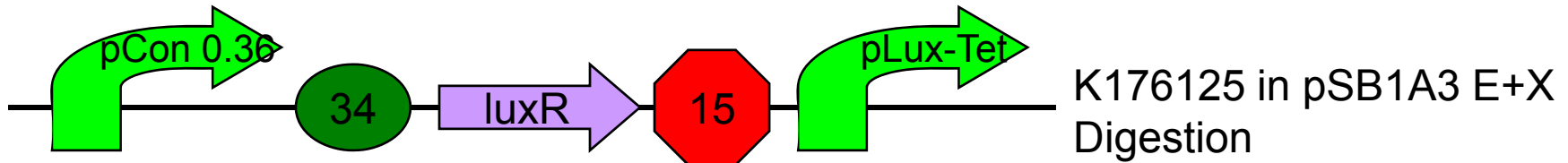
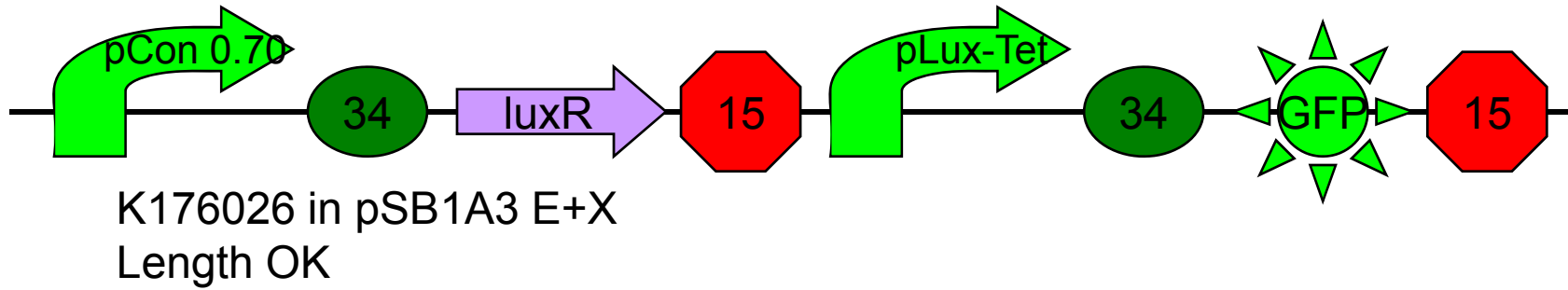
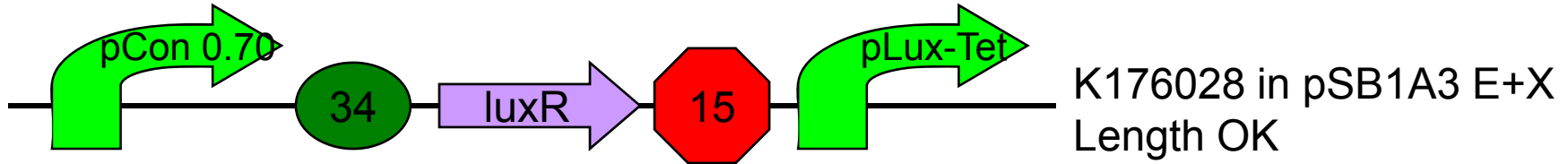
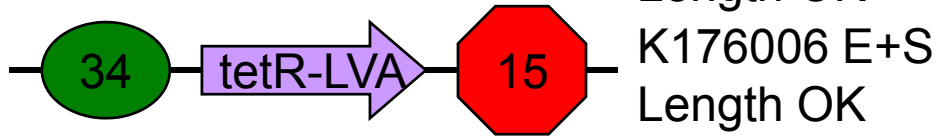
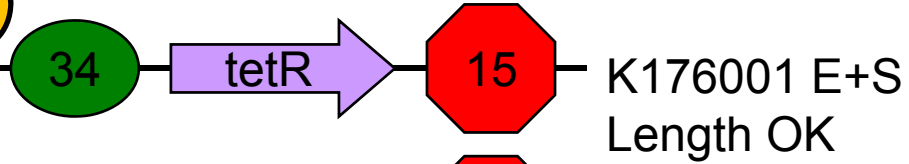



K176057  
Synthesis OK

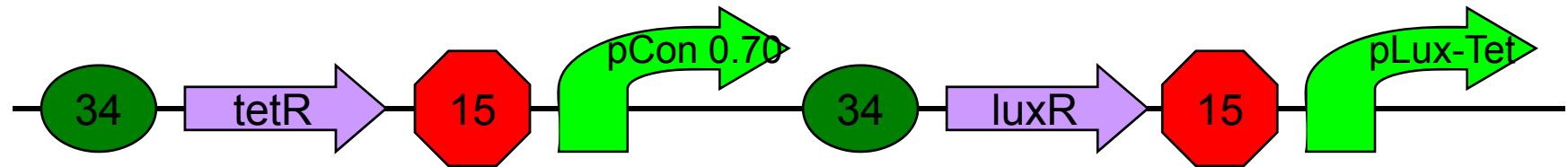

K176031 in pSB1A3  
Sequence OK

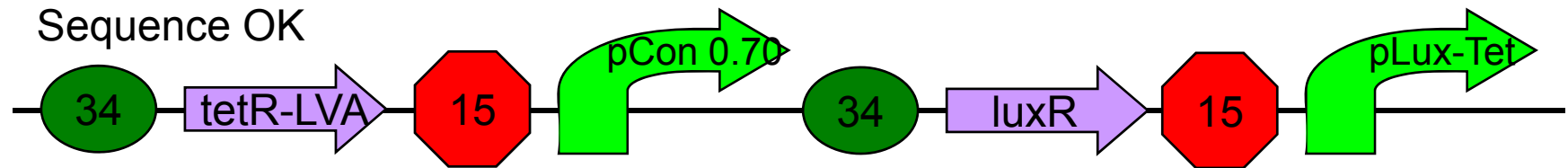

K176032 in pSB1A3  
Sequence OK

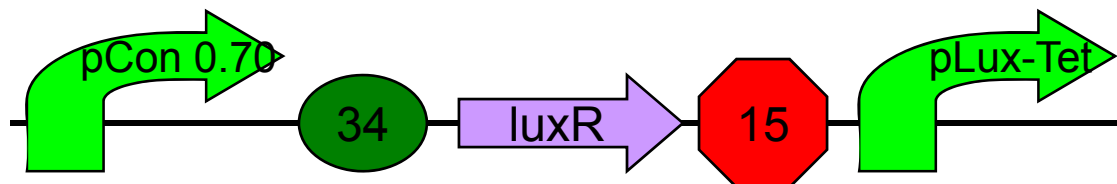
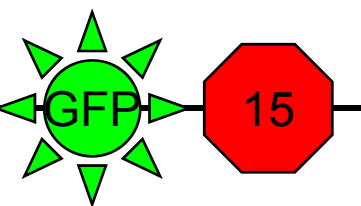
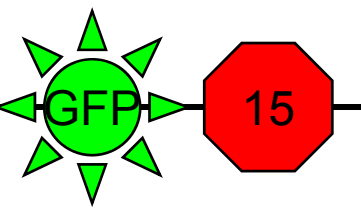
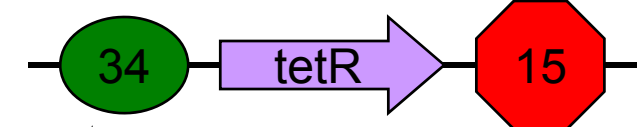

K176029 in pSB1A3  
Sequence ?

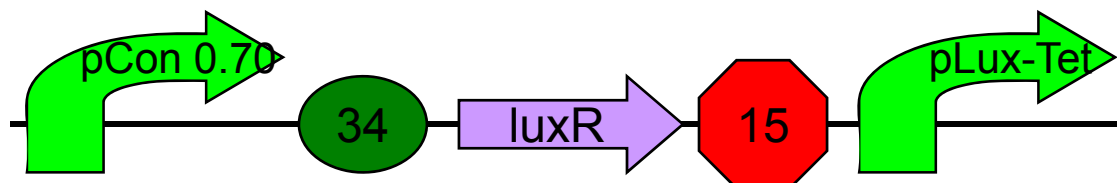

K176030 in pSB1A3  
Sequence ?



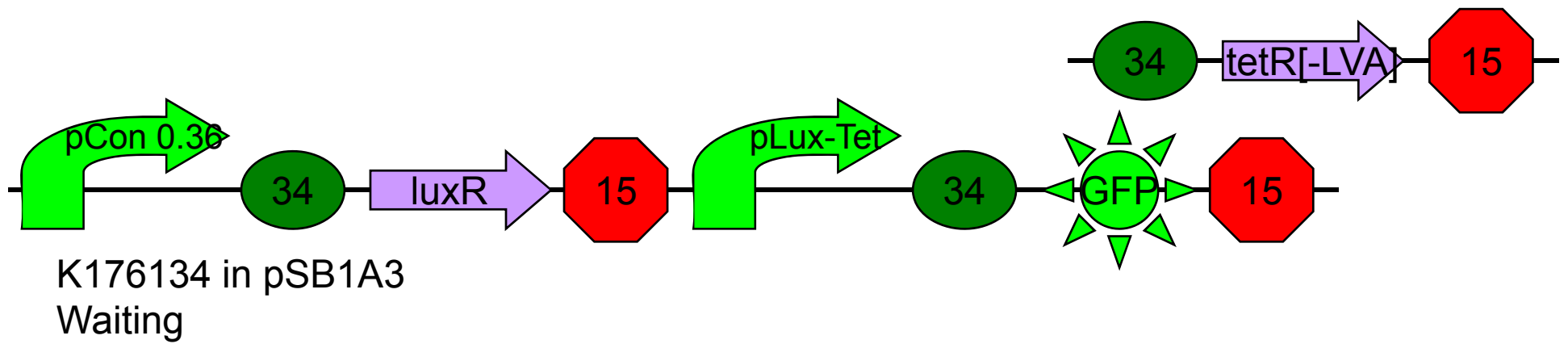
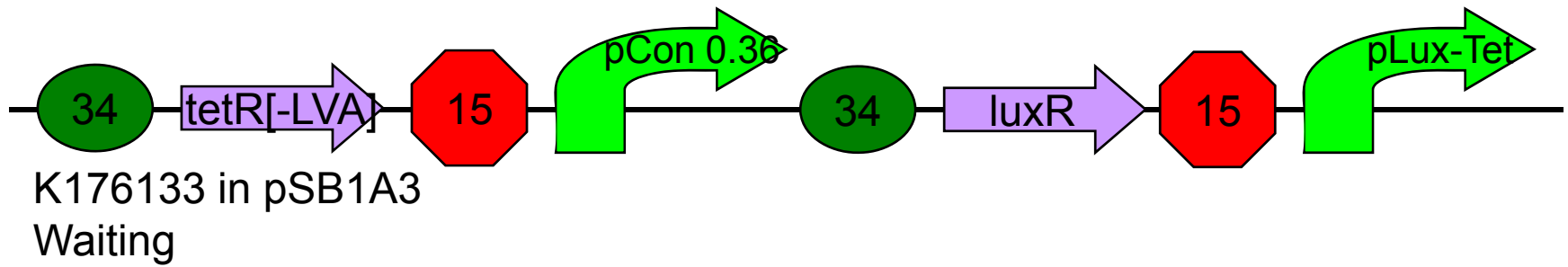

13

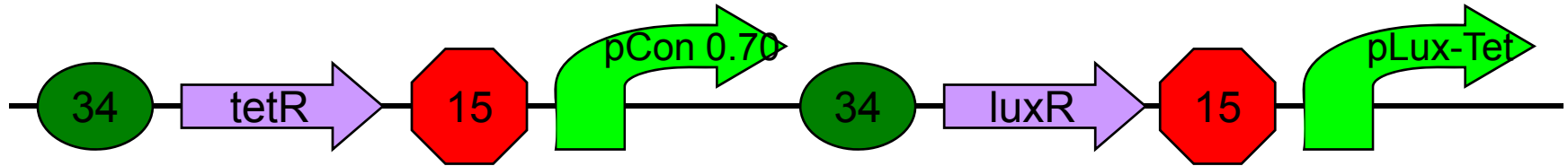

K176031 X+P  
Length OK

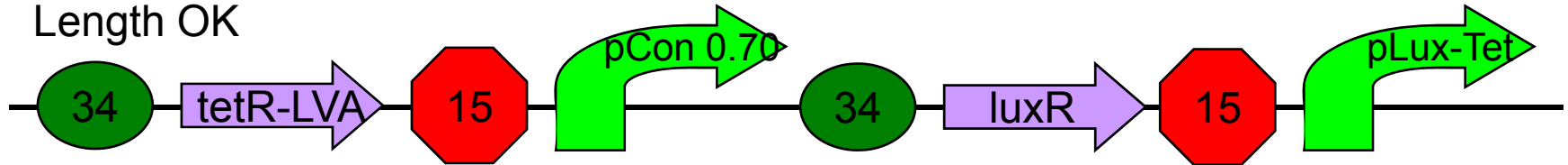

K176032 X+P  
Length OK

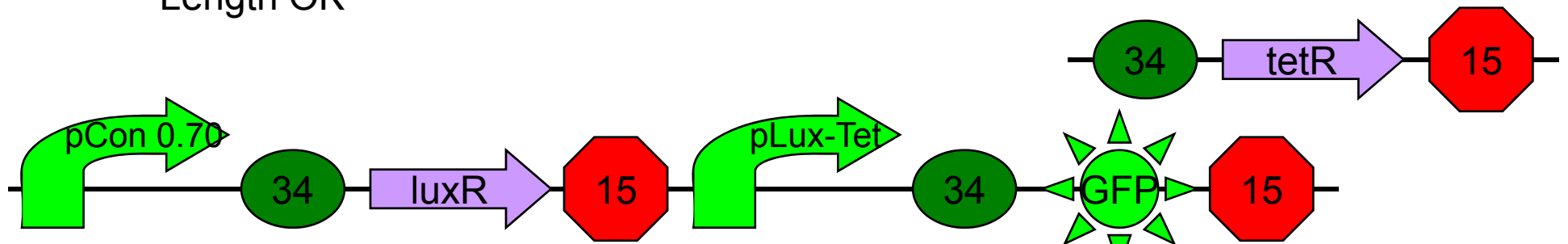

K176029 X+P  
Length OK

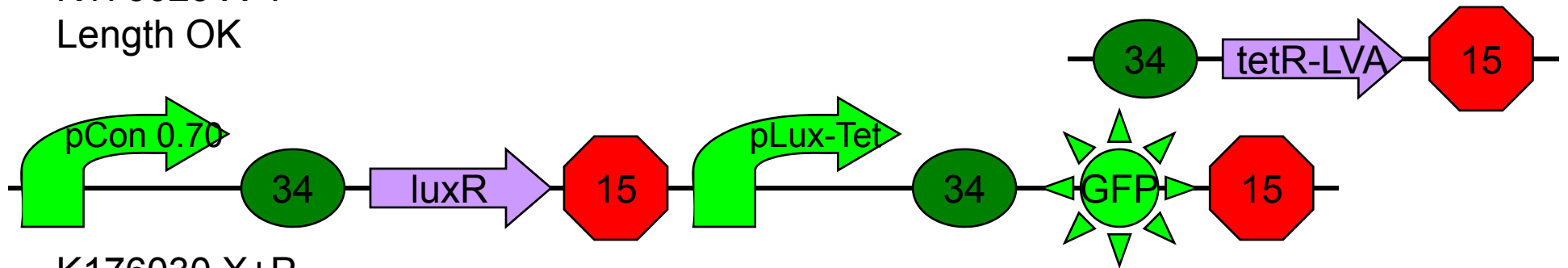

K176030 X+P  
Length OK

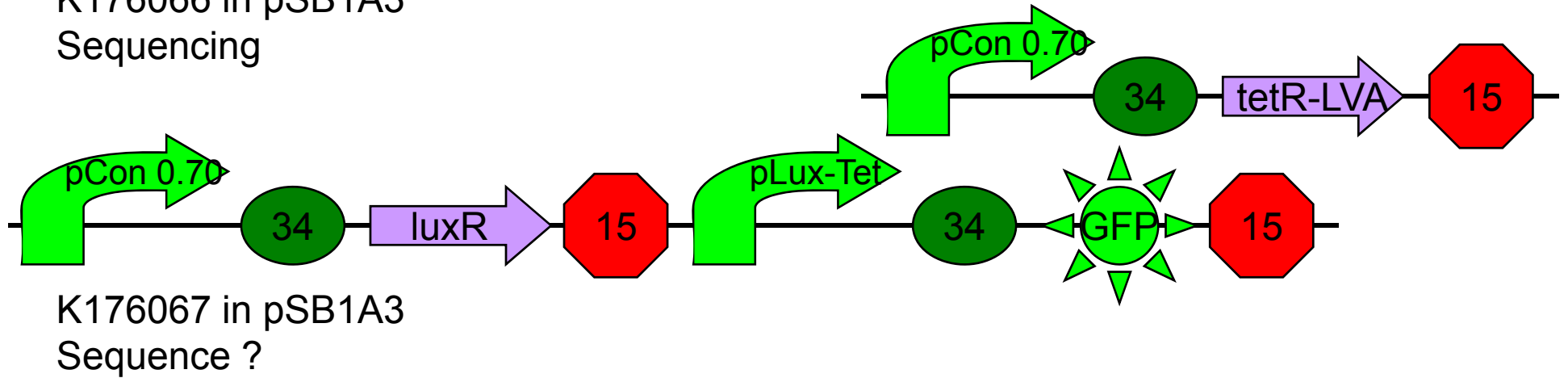
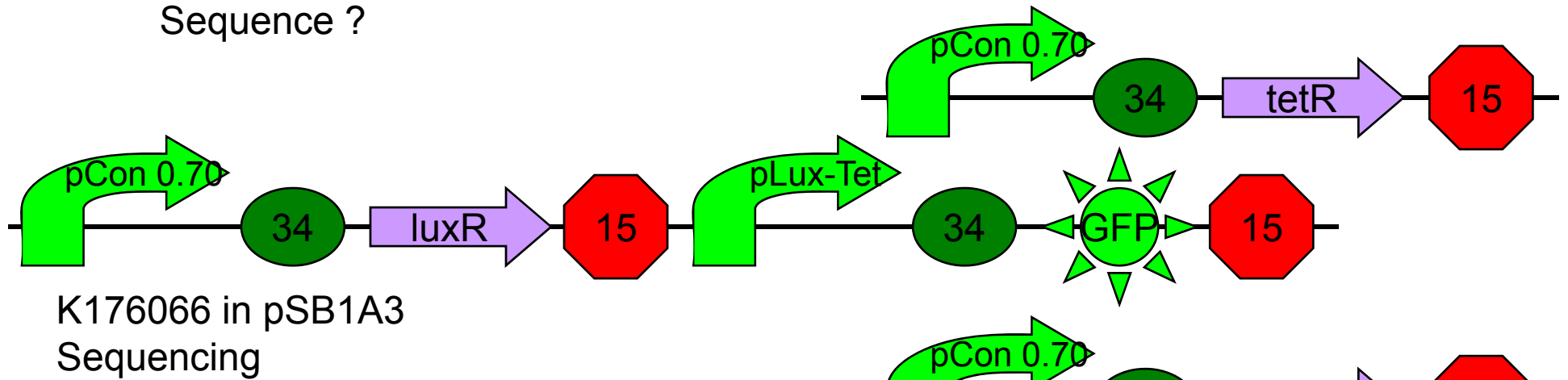
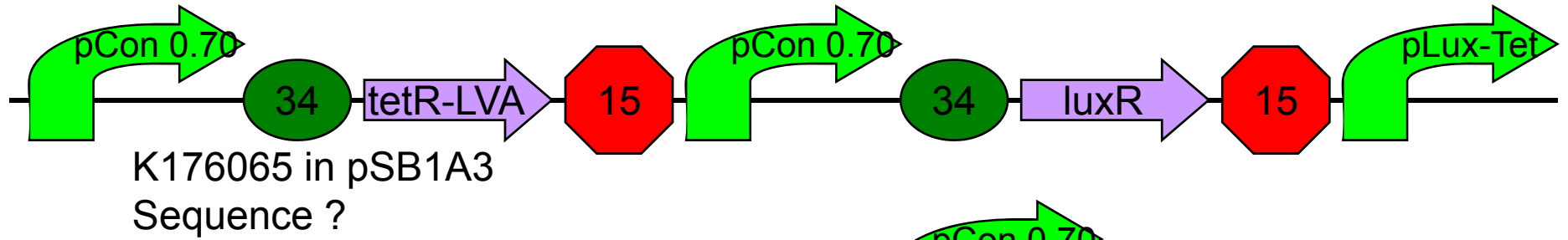
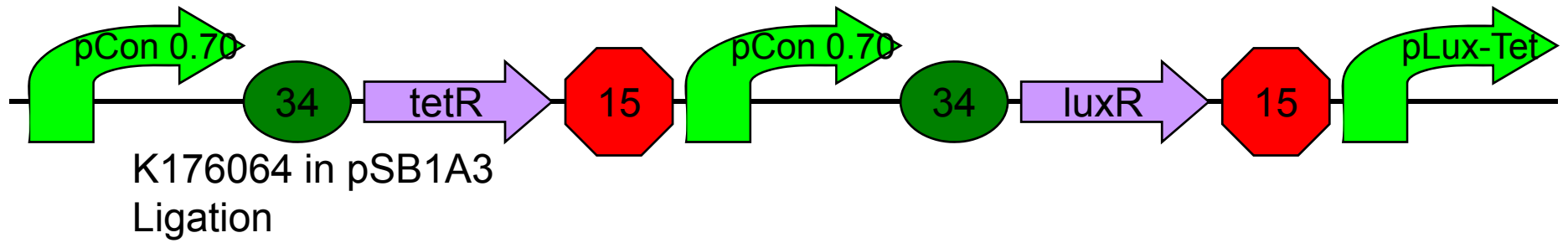

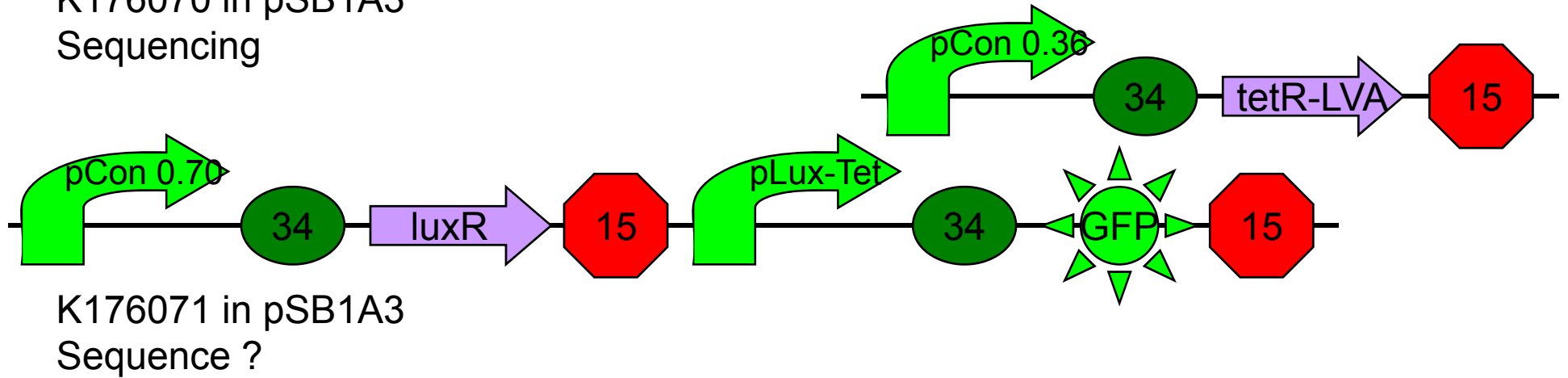
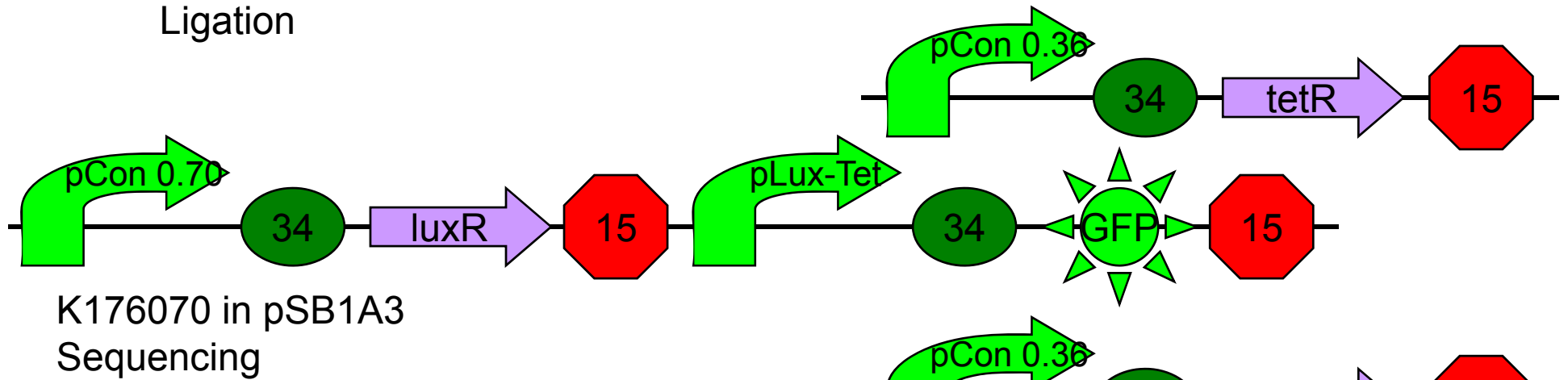
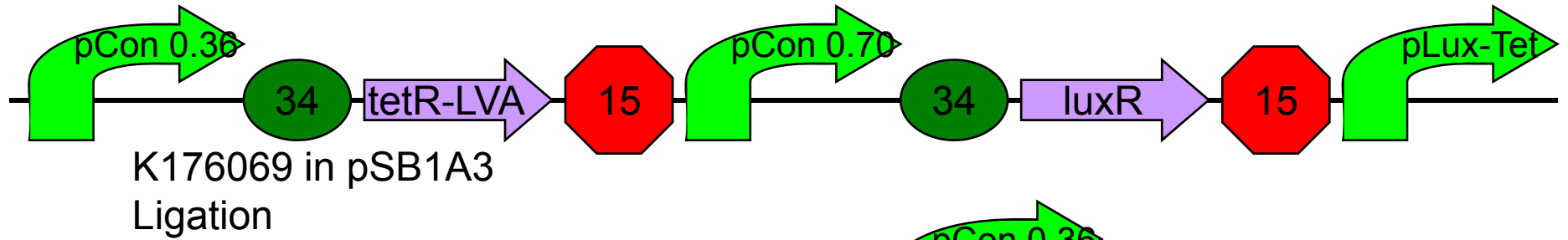
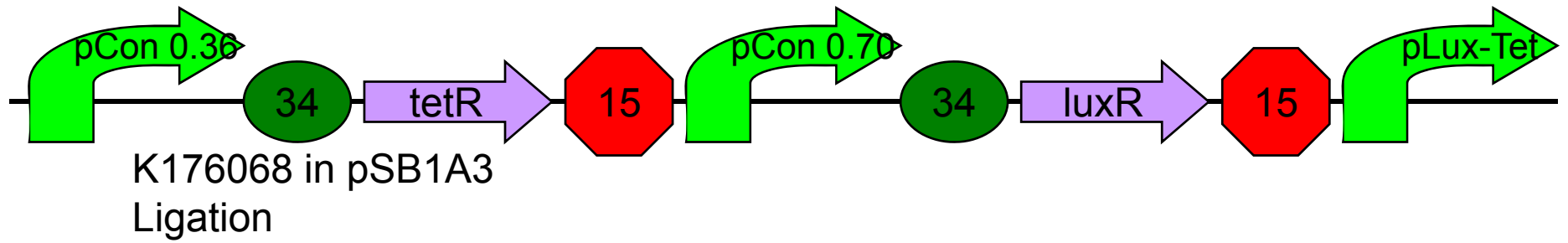

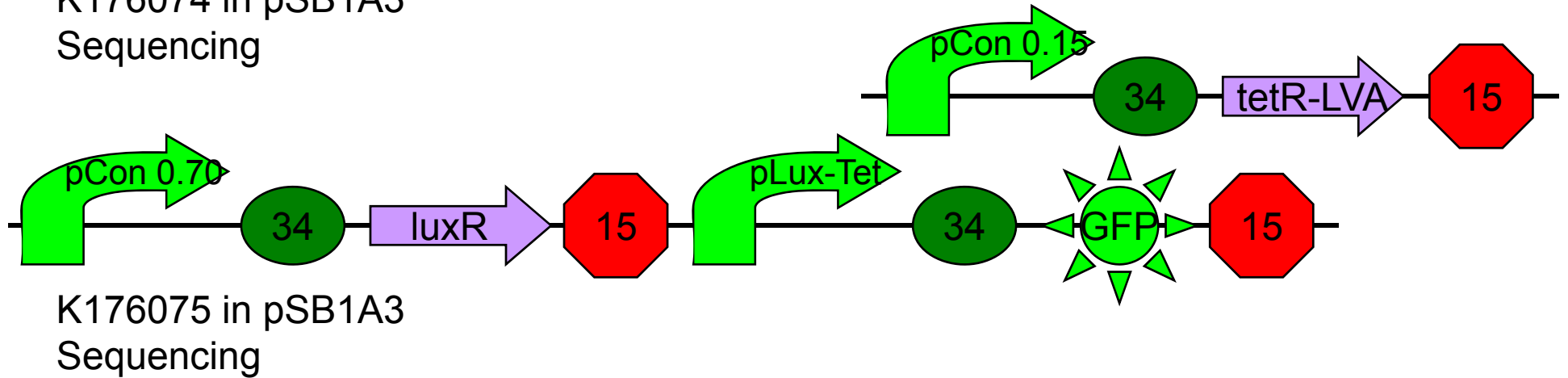
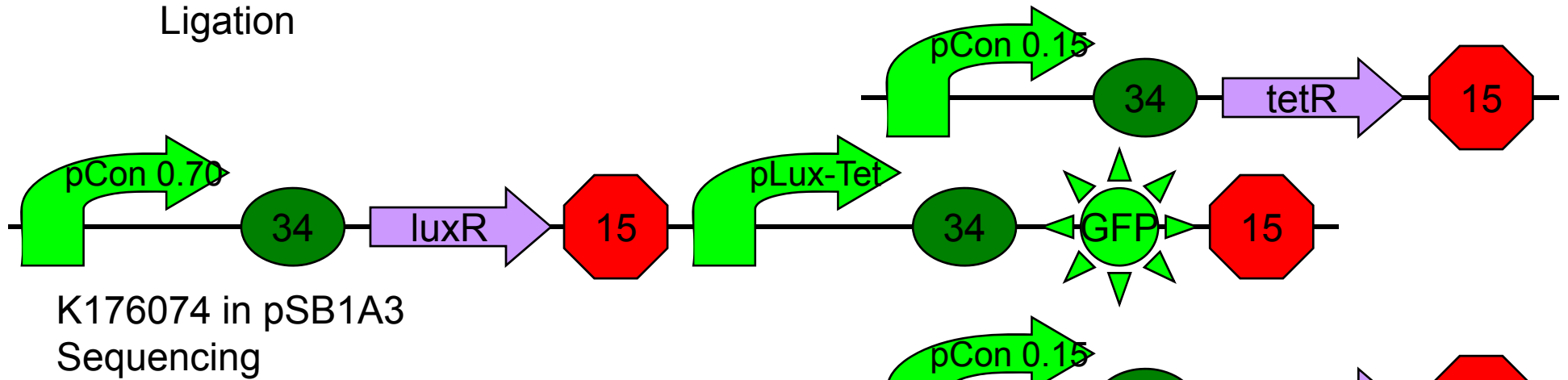
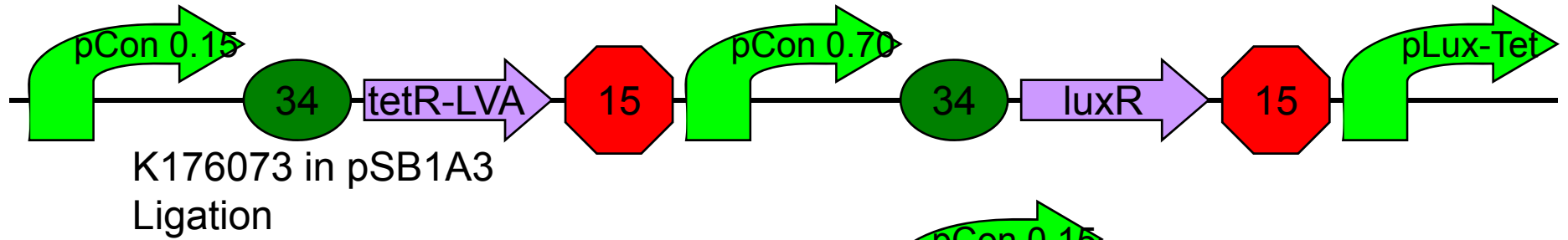
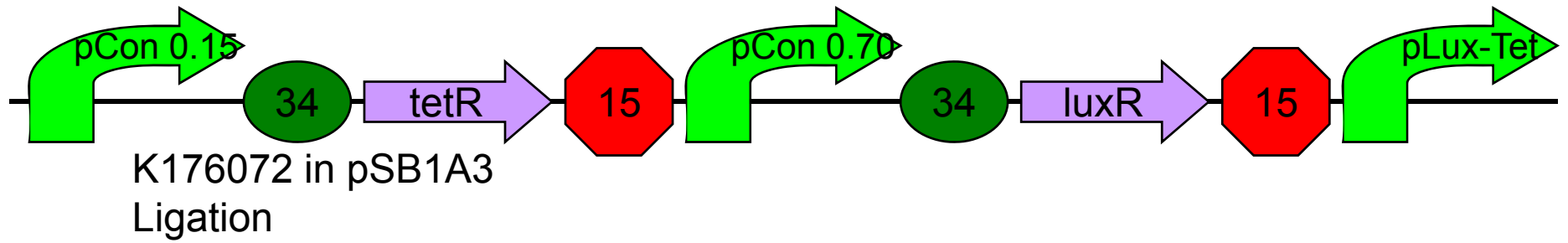

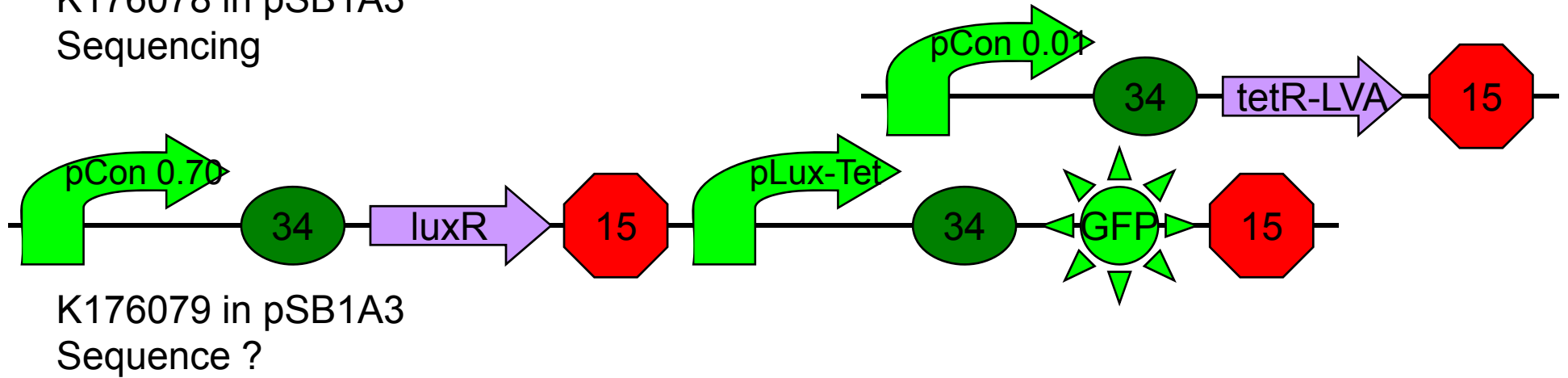
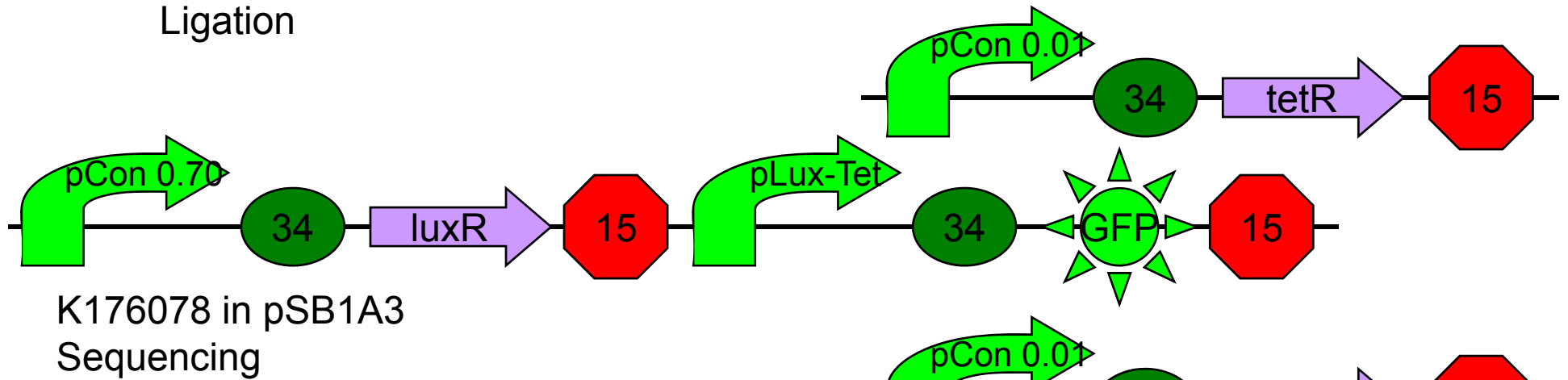
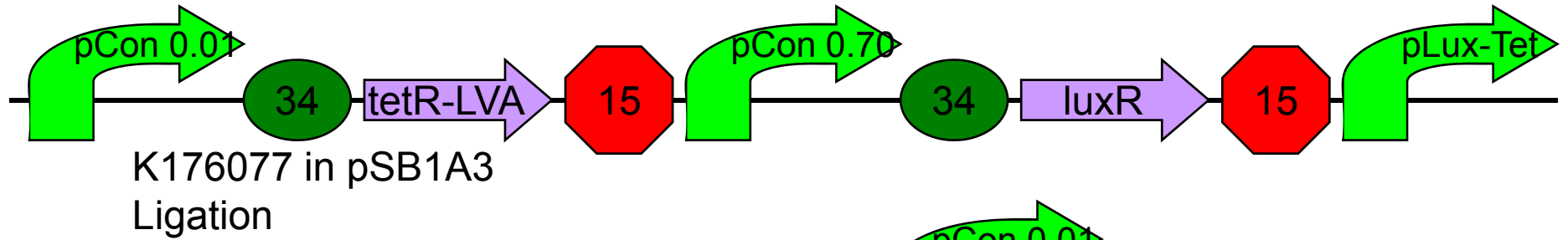
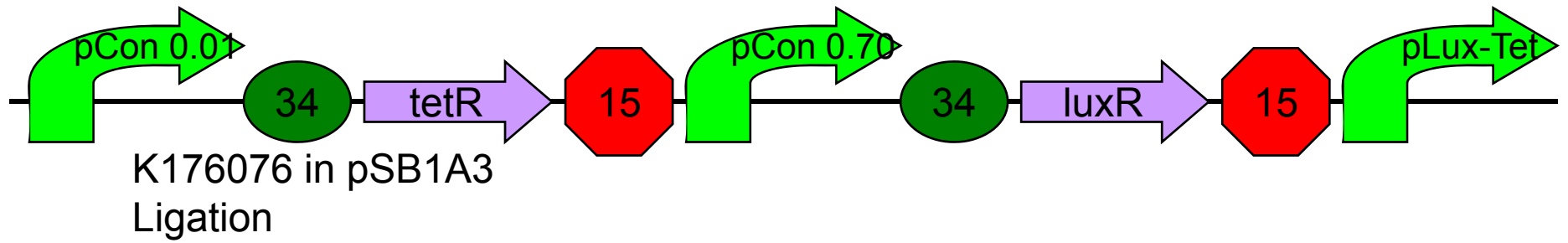

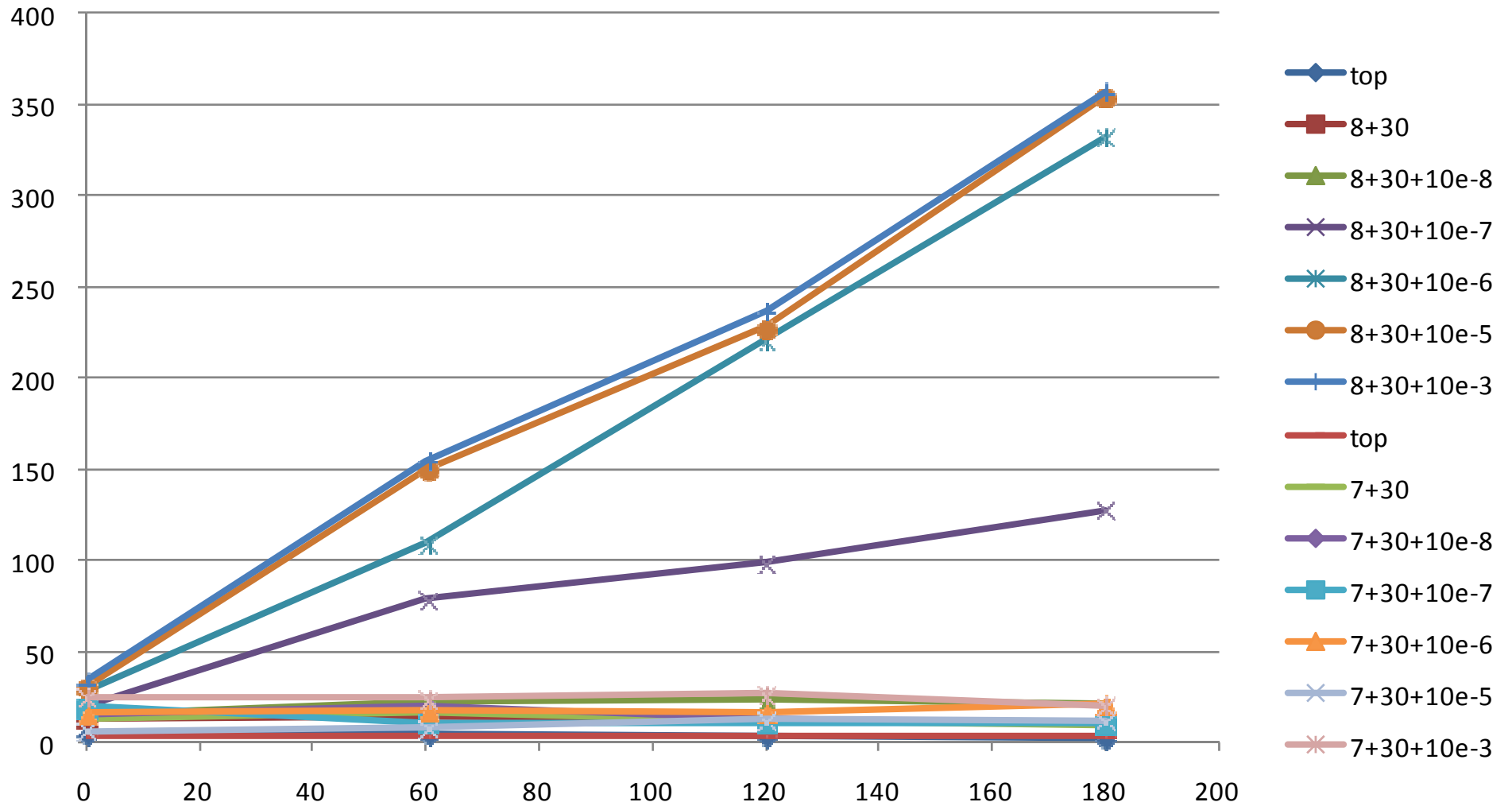

# K176067 (7+30)

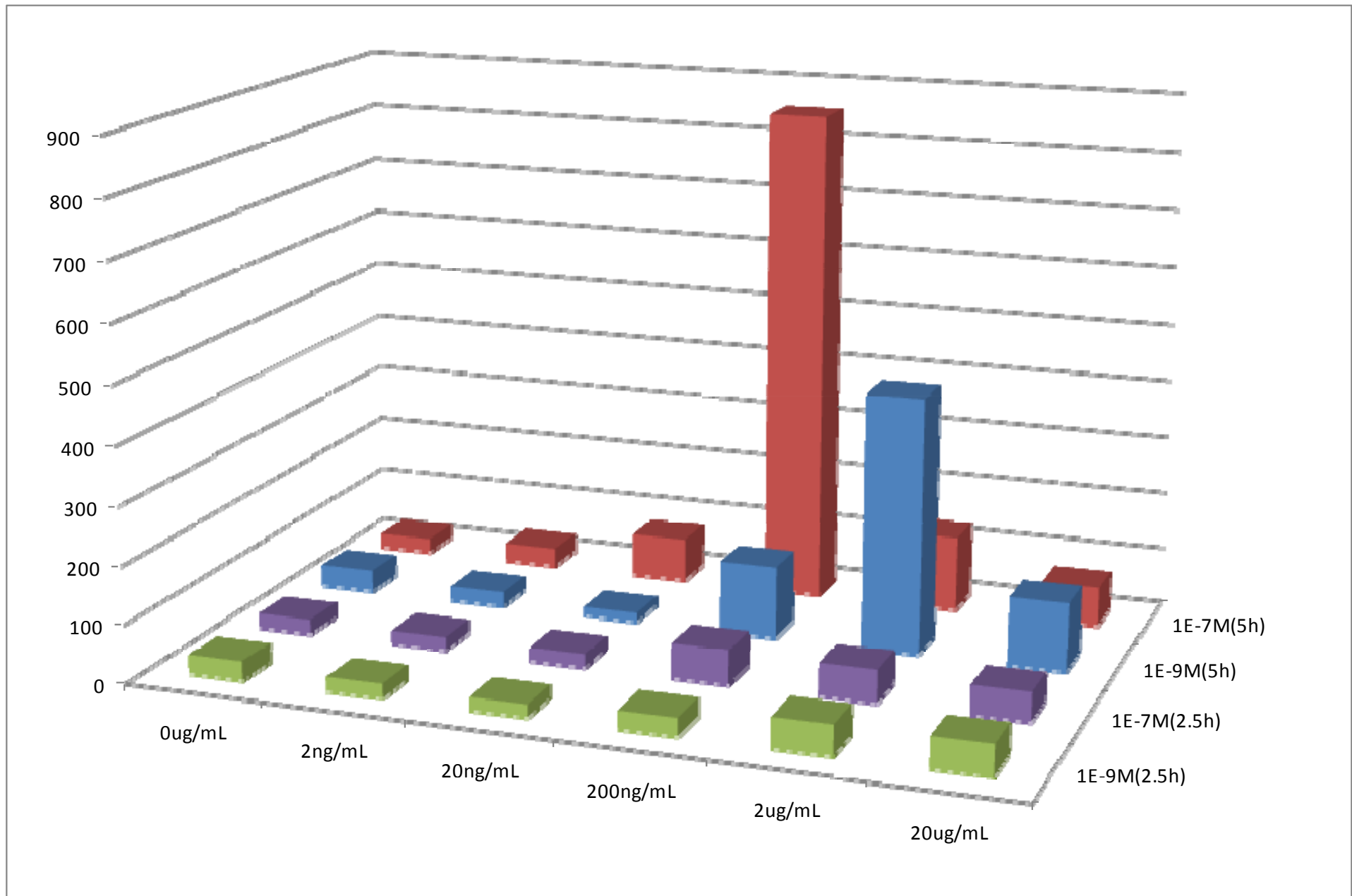



# K176070 (9+29)

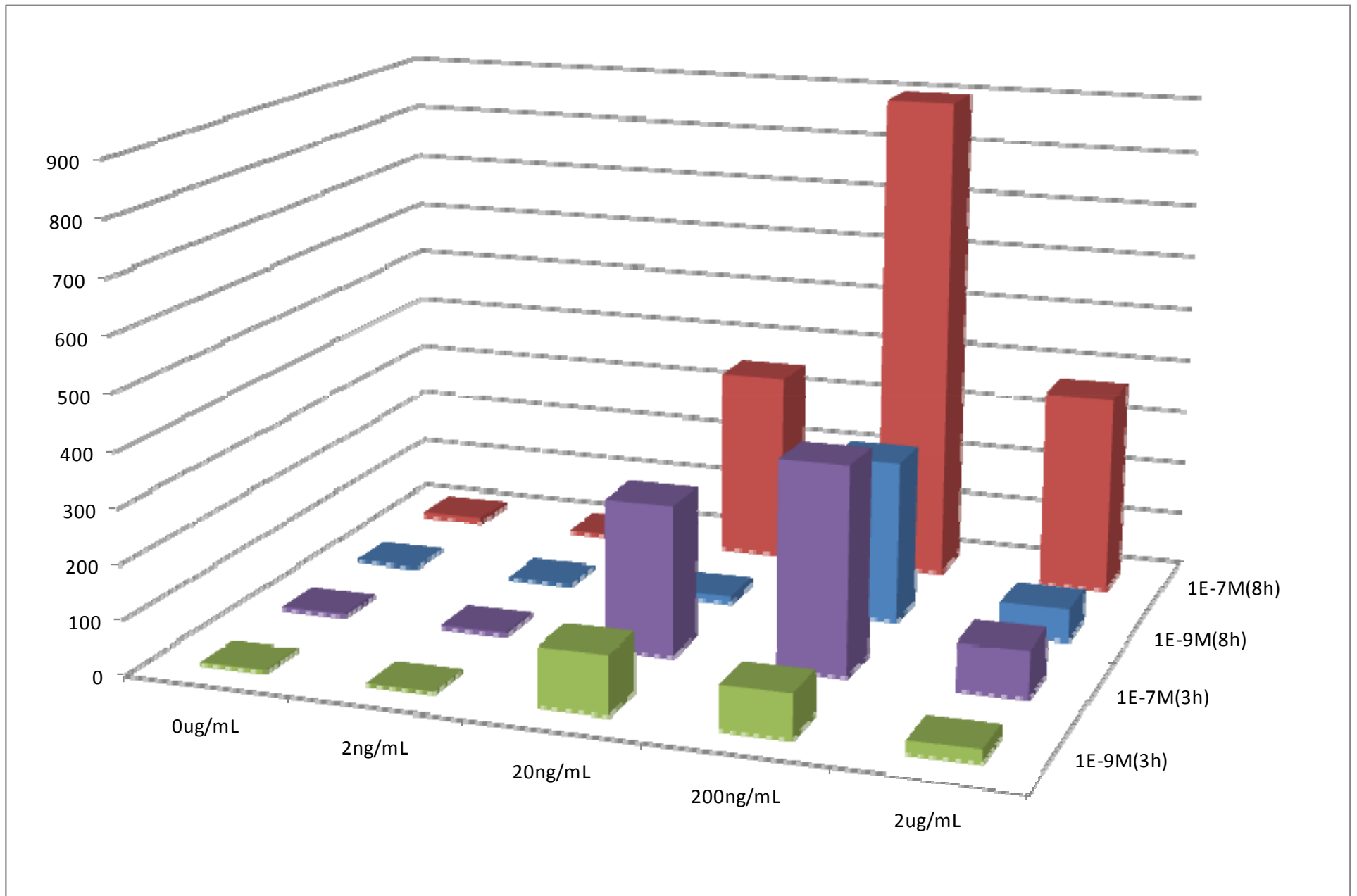

# K176071 (9+30)

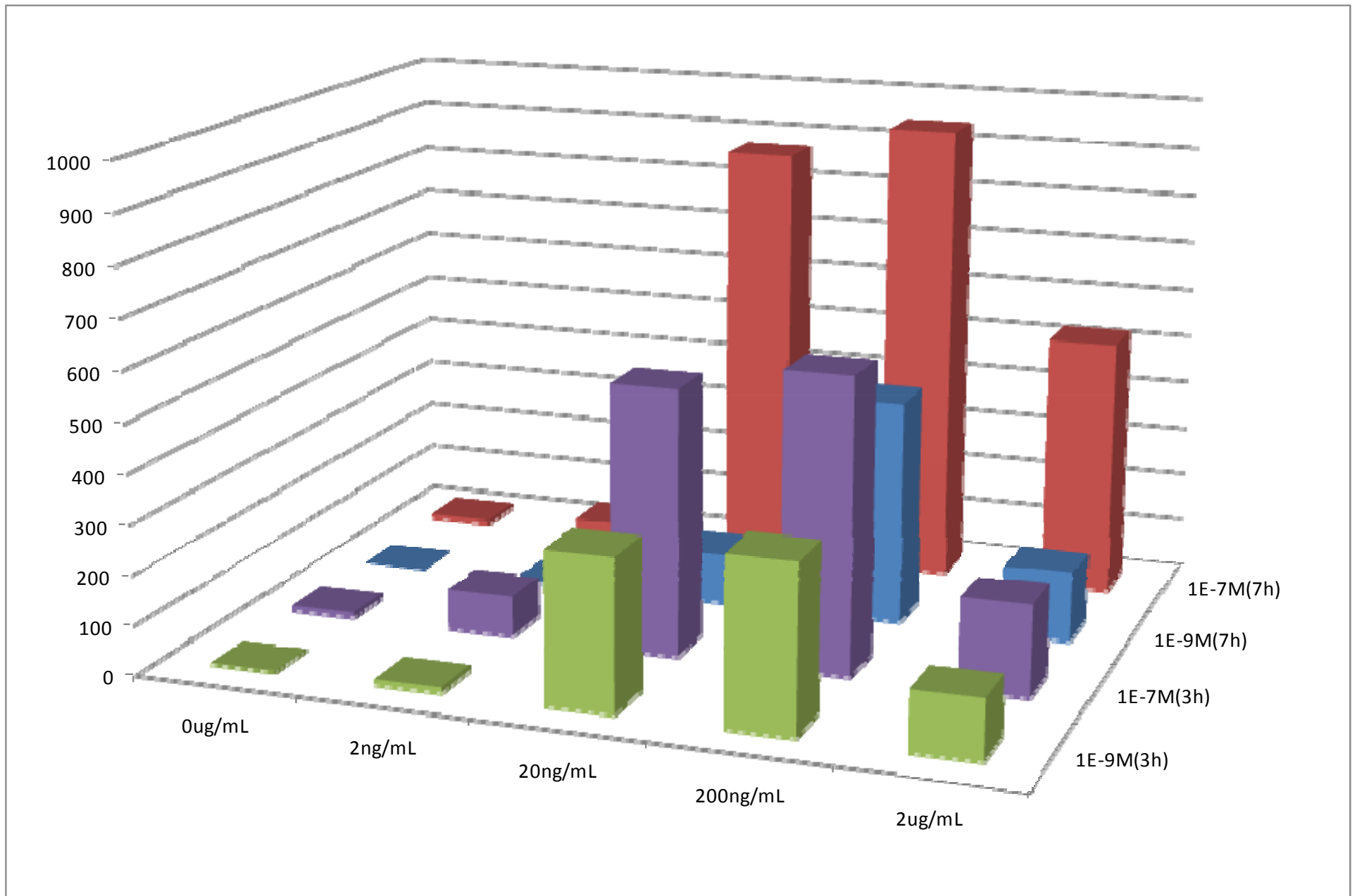

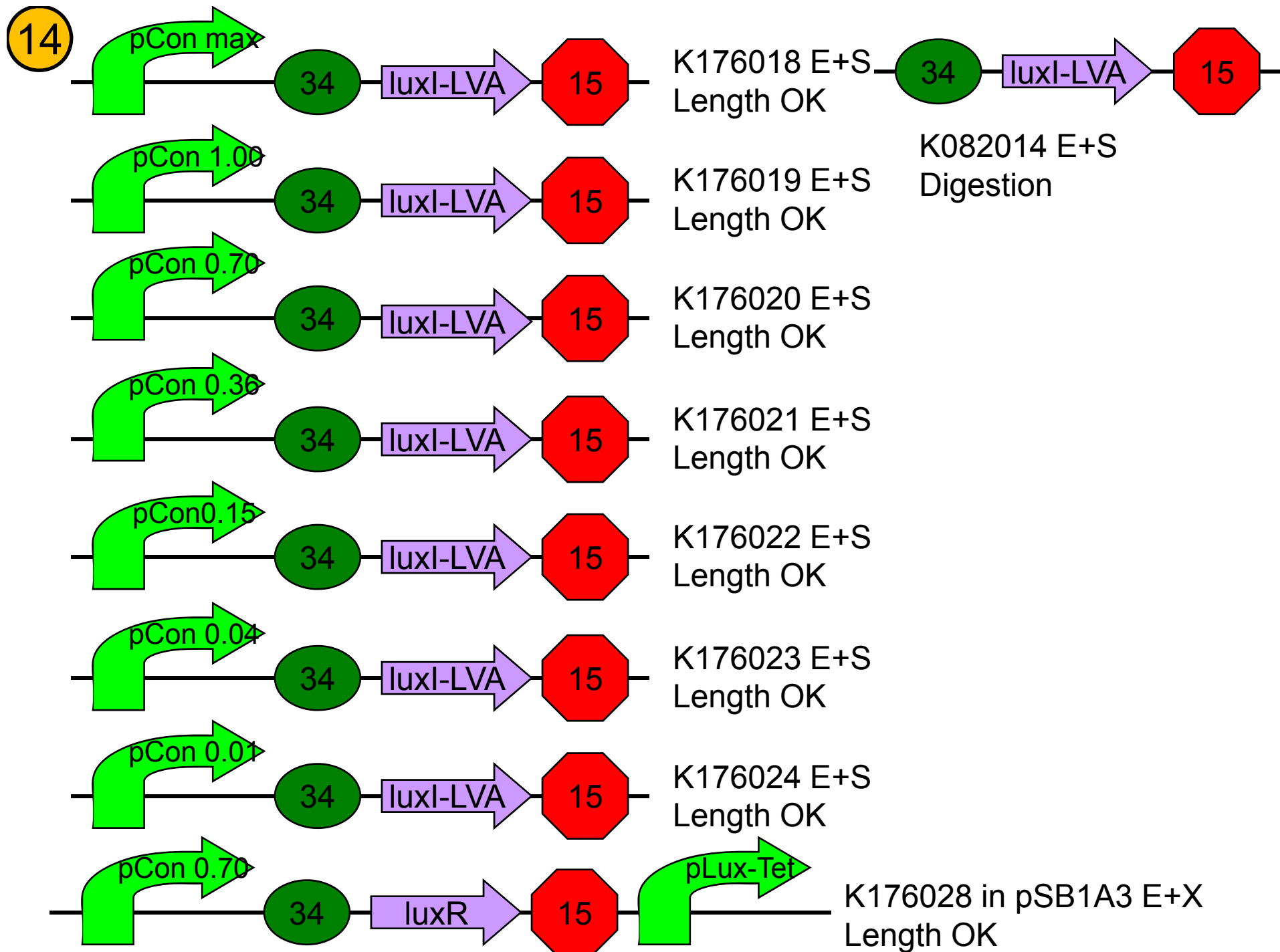

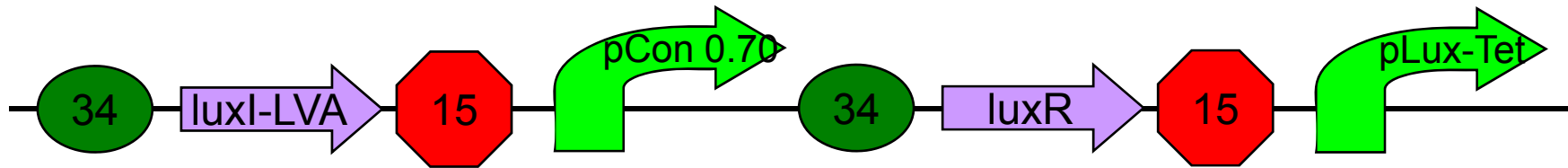

K176080 in pSB1A3  
Waiting

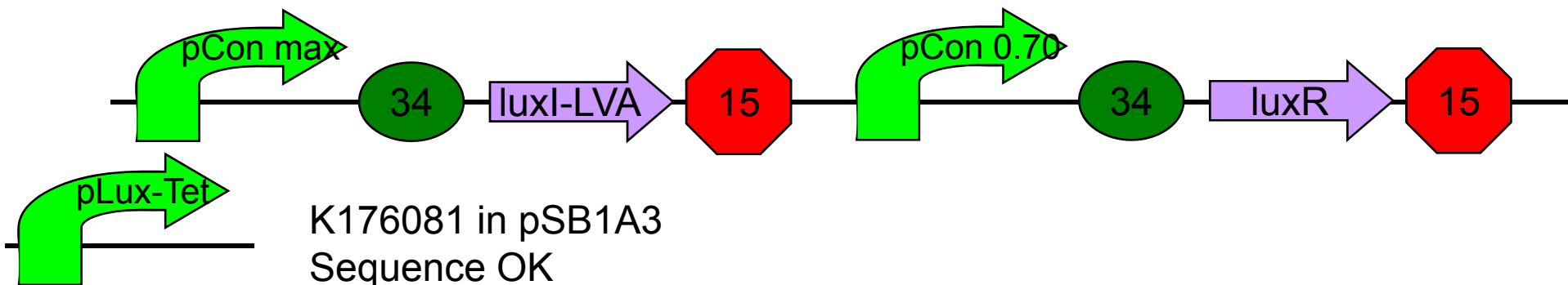

K176081 in pSB1A3  
Sequence OK

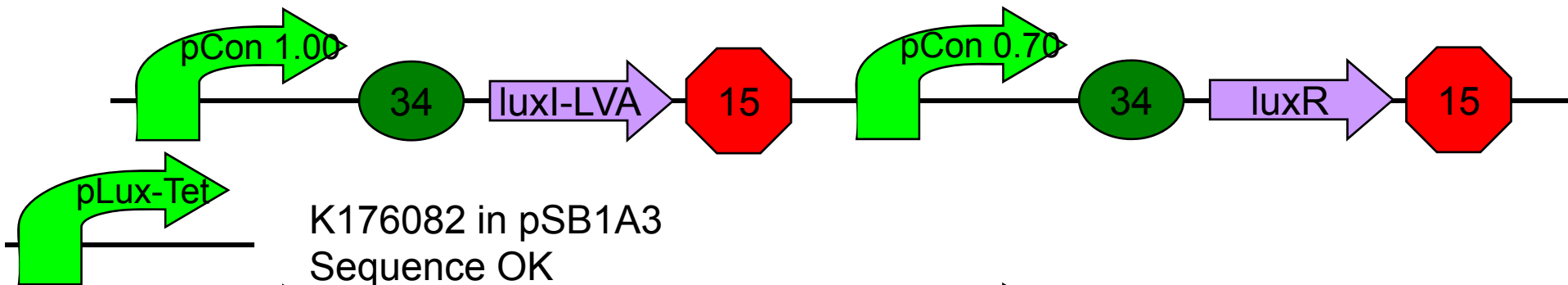

K176082 in pSB1A3  
Sequence OK

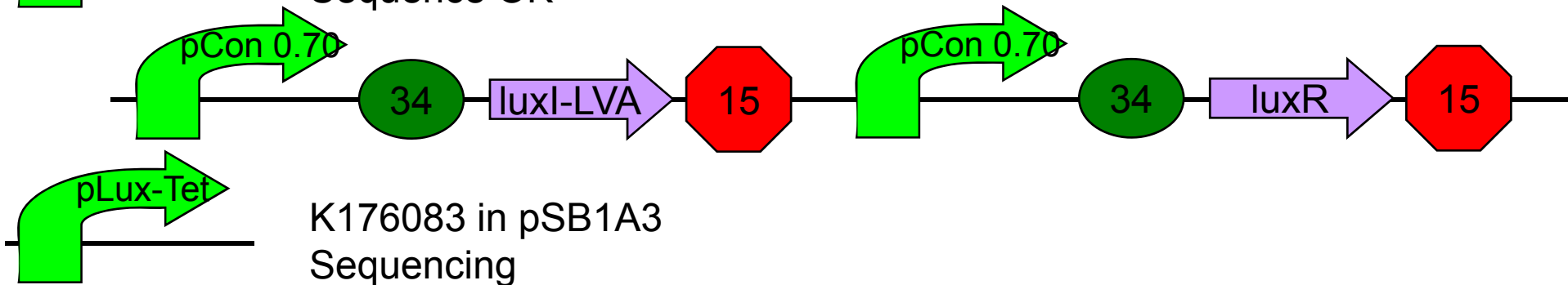

K176083 in pSB1A3  
Sequencing

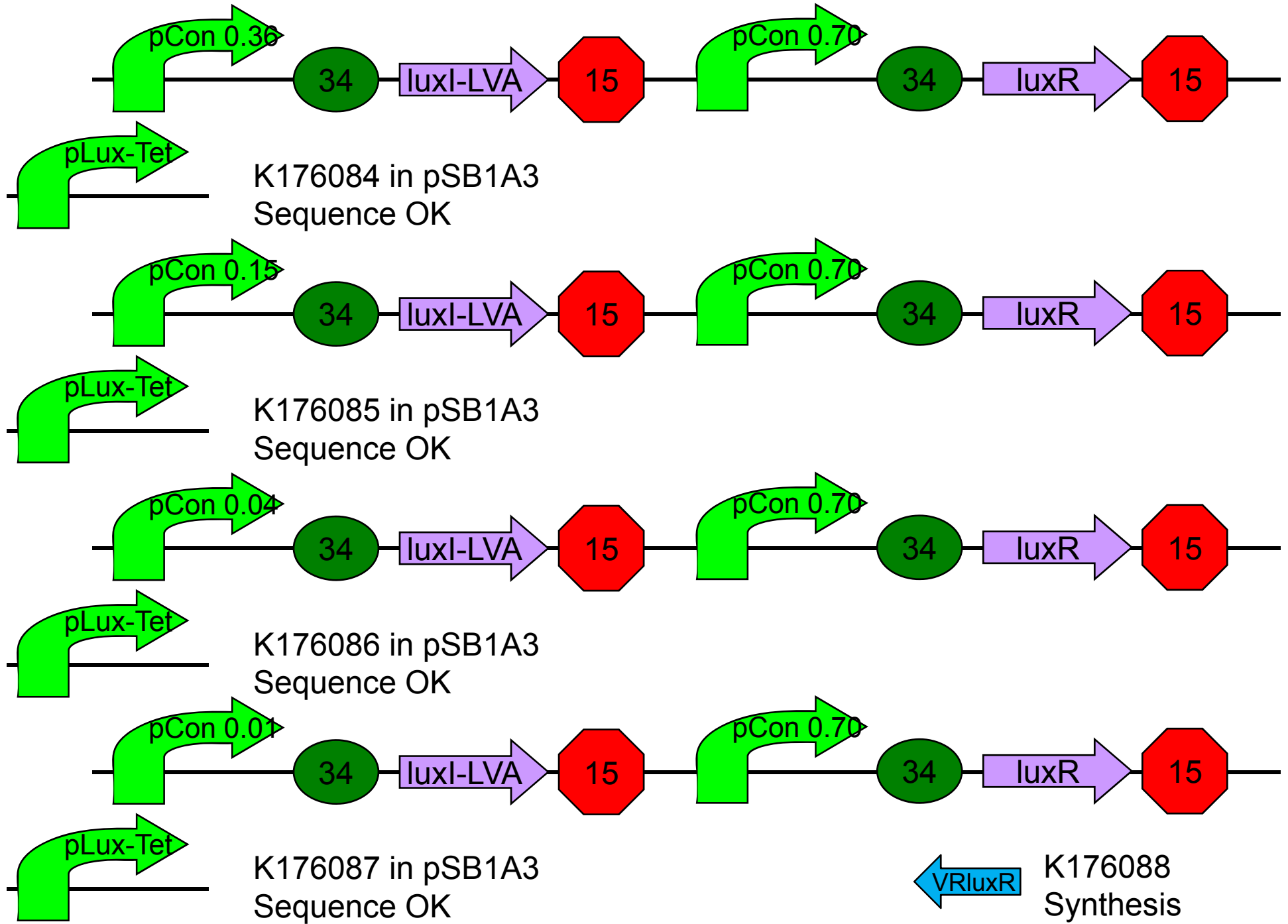

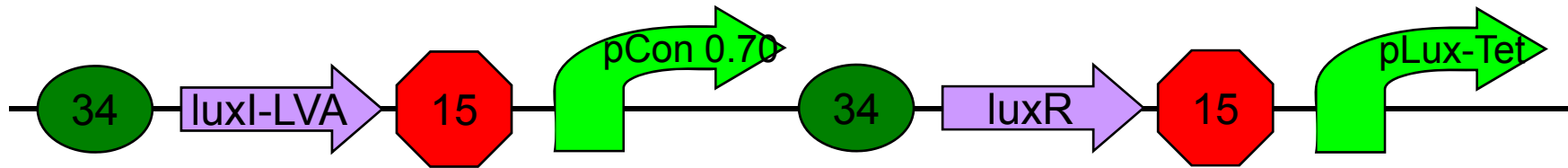

K176080 in pSB1A3 S+P  
Waiting

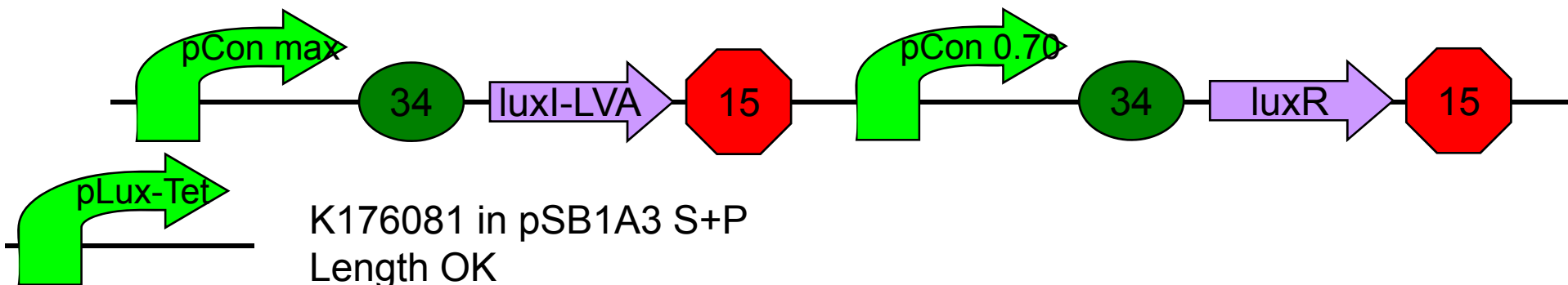

K176081 in pSB1A3 S+P  
Length OK

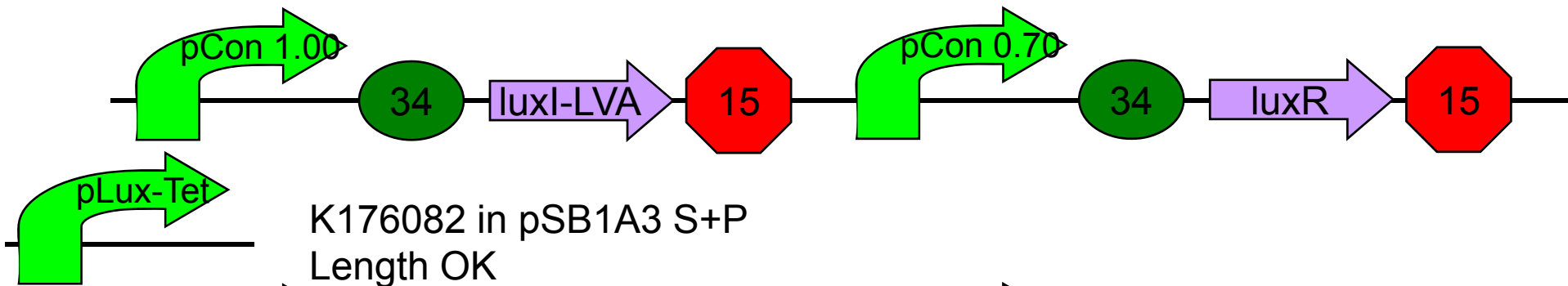

K176082 in pSB1A3 S+P  
Length OK

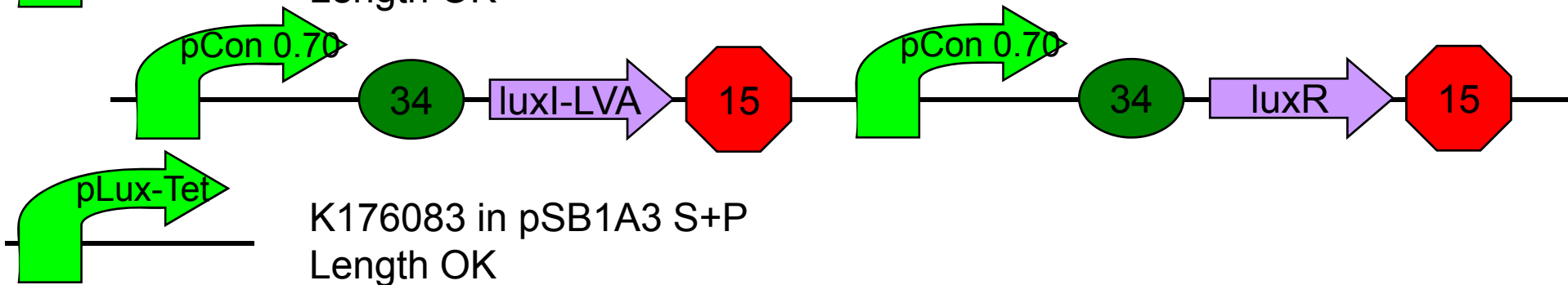

K176083 in pSB1A3 S+P  
Length OK

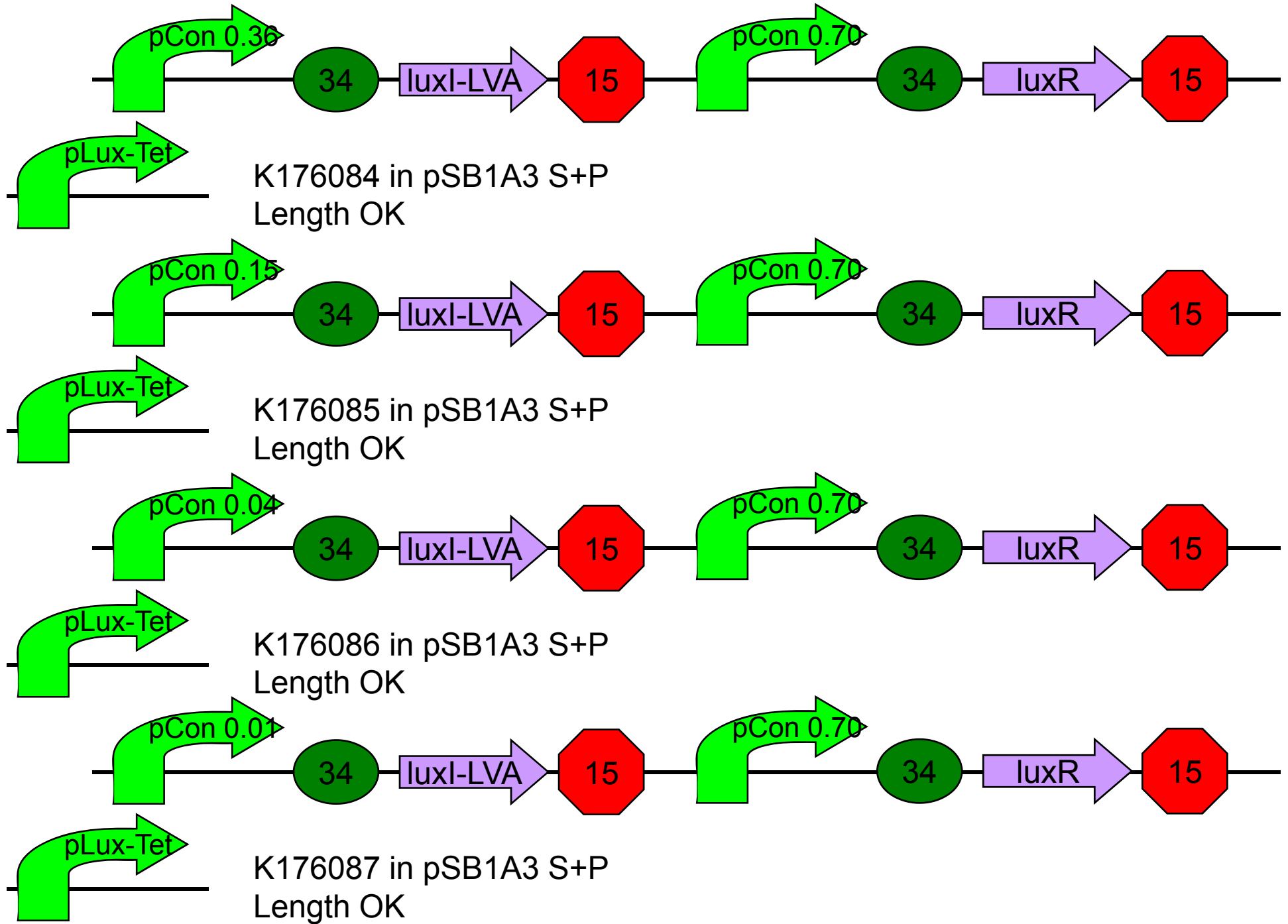

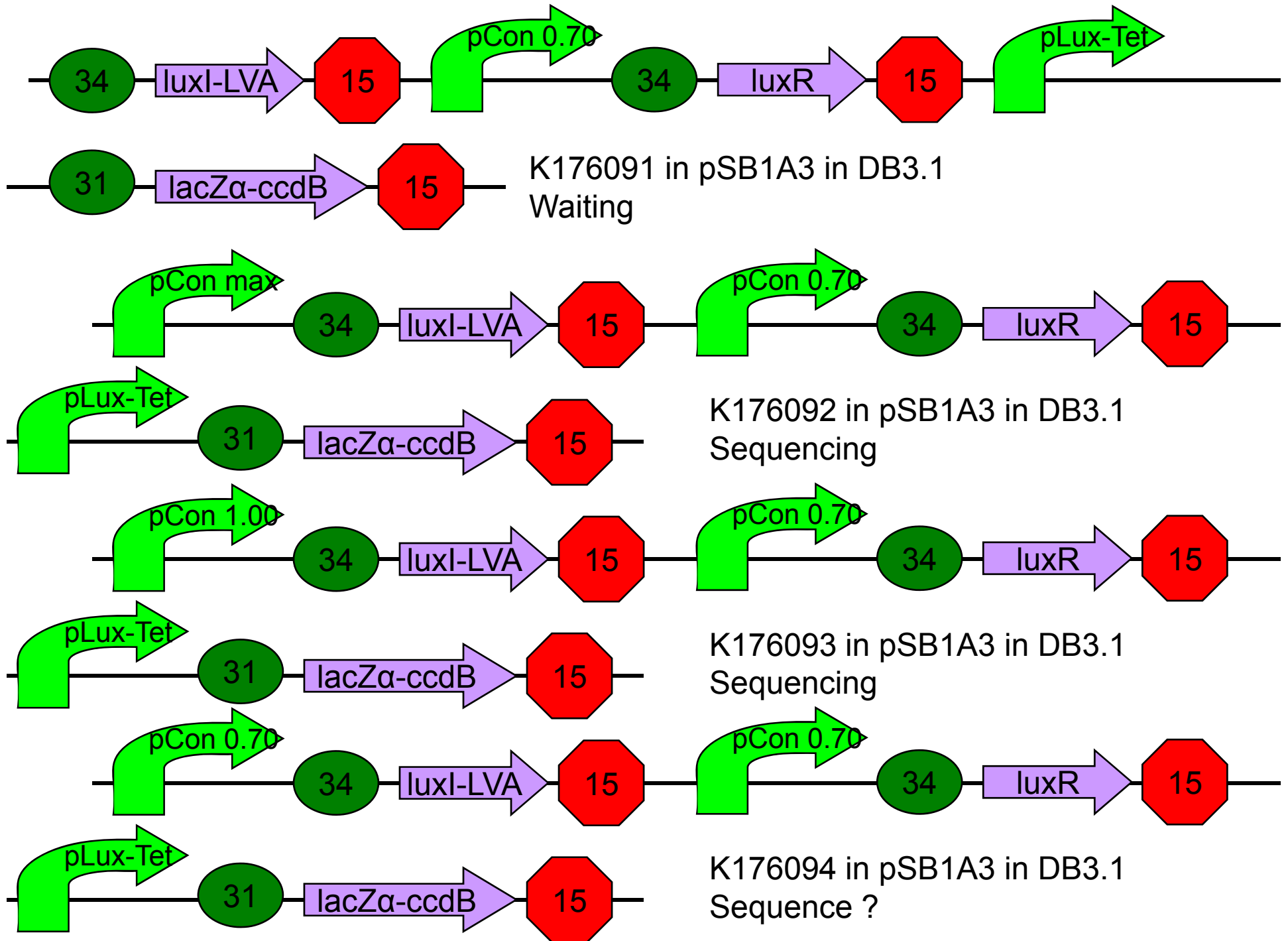



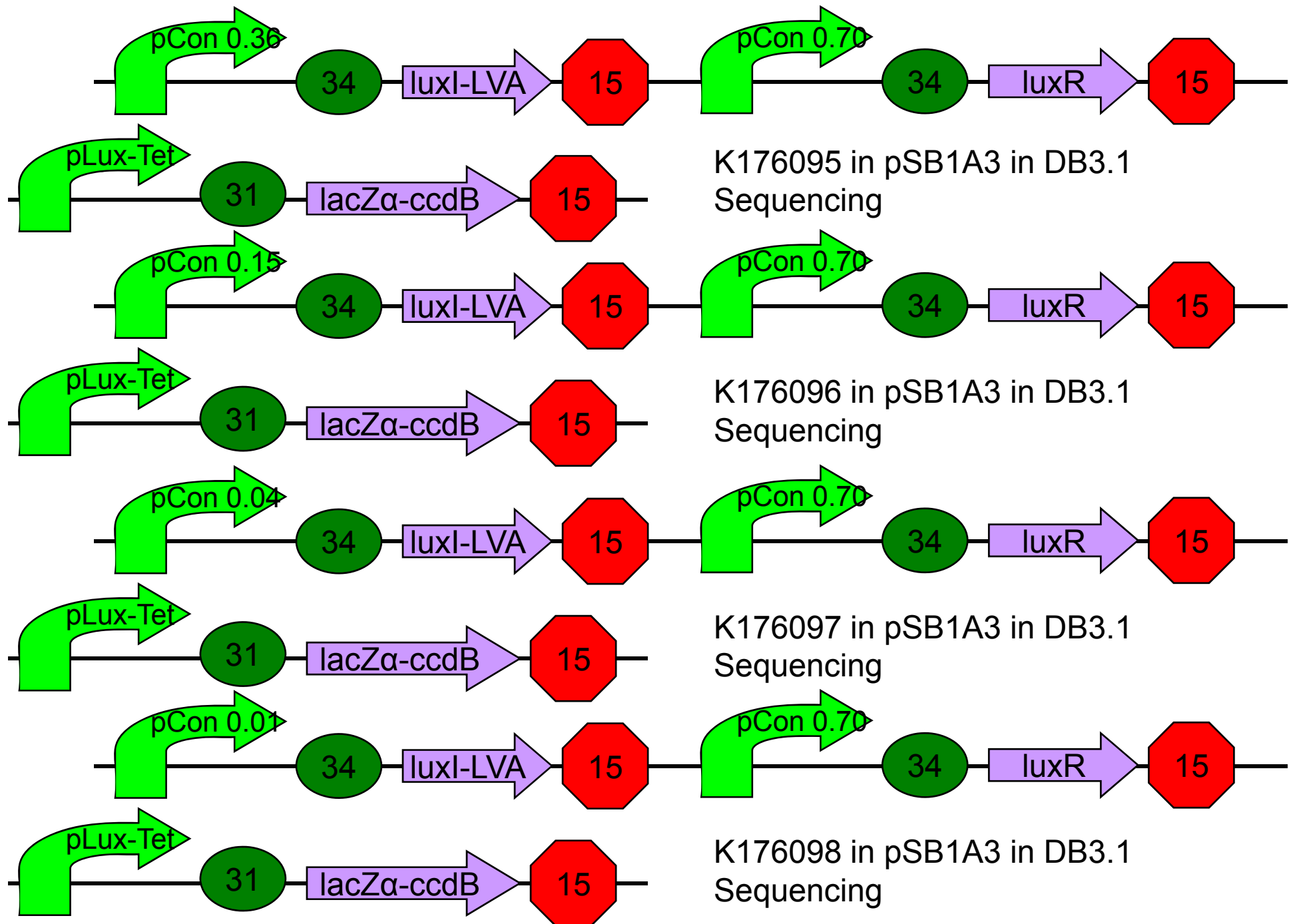

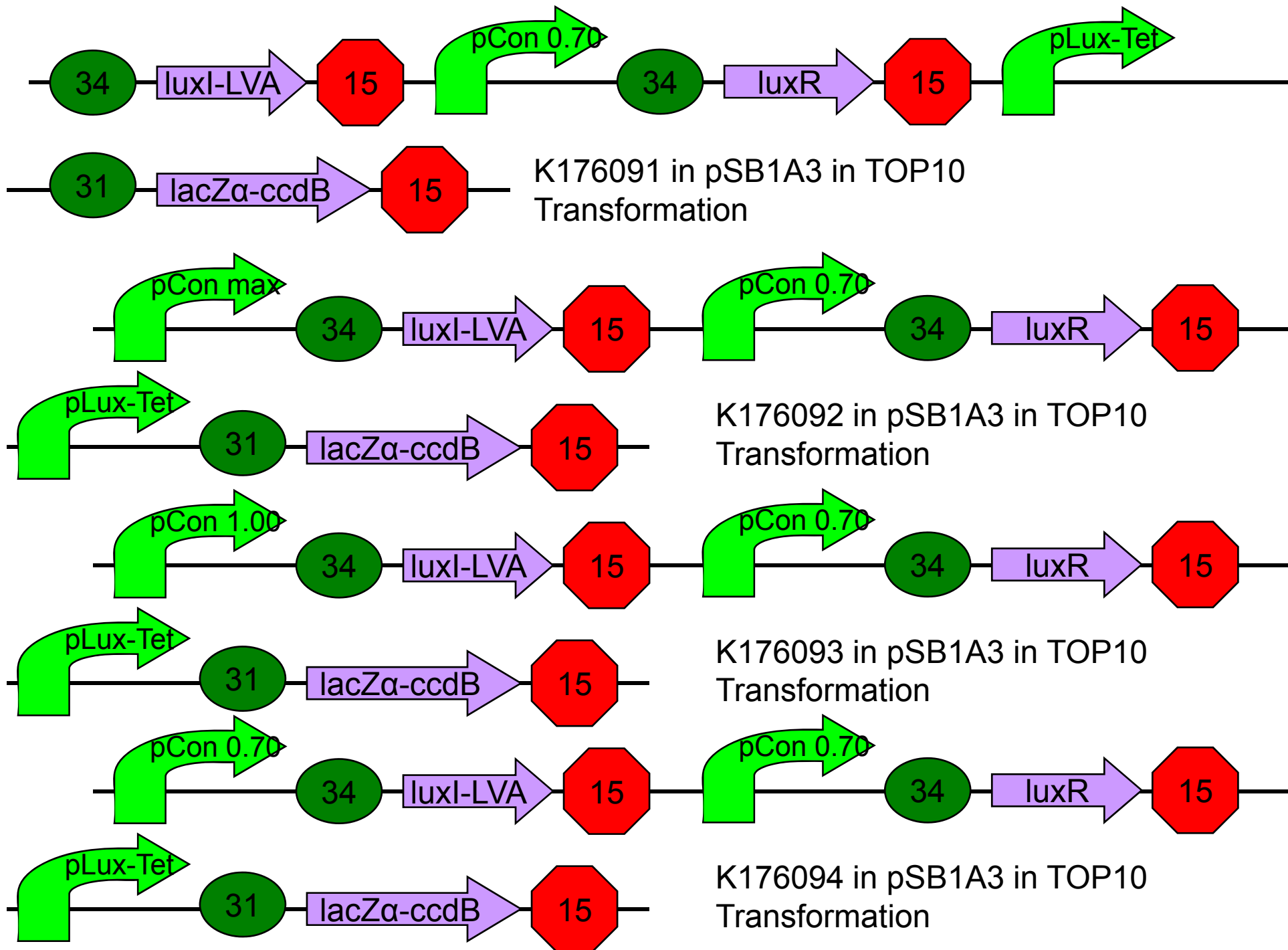

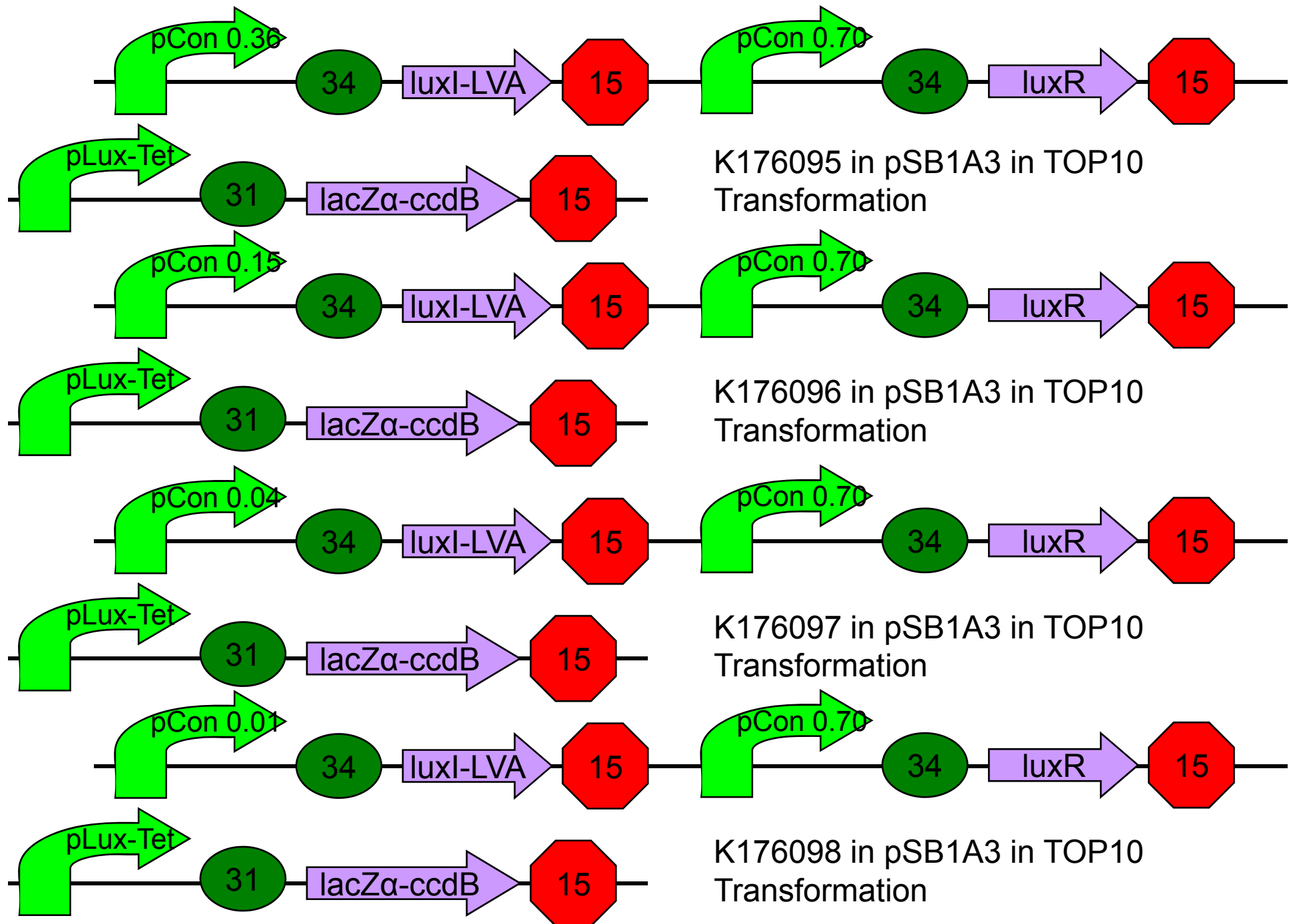

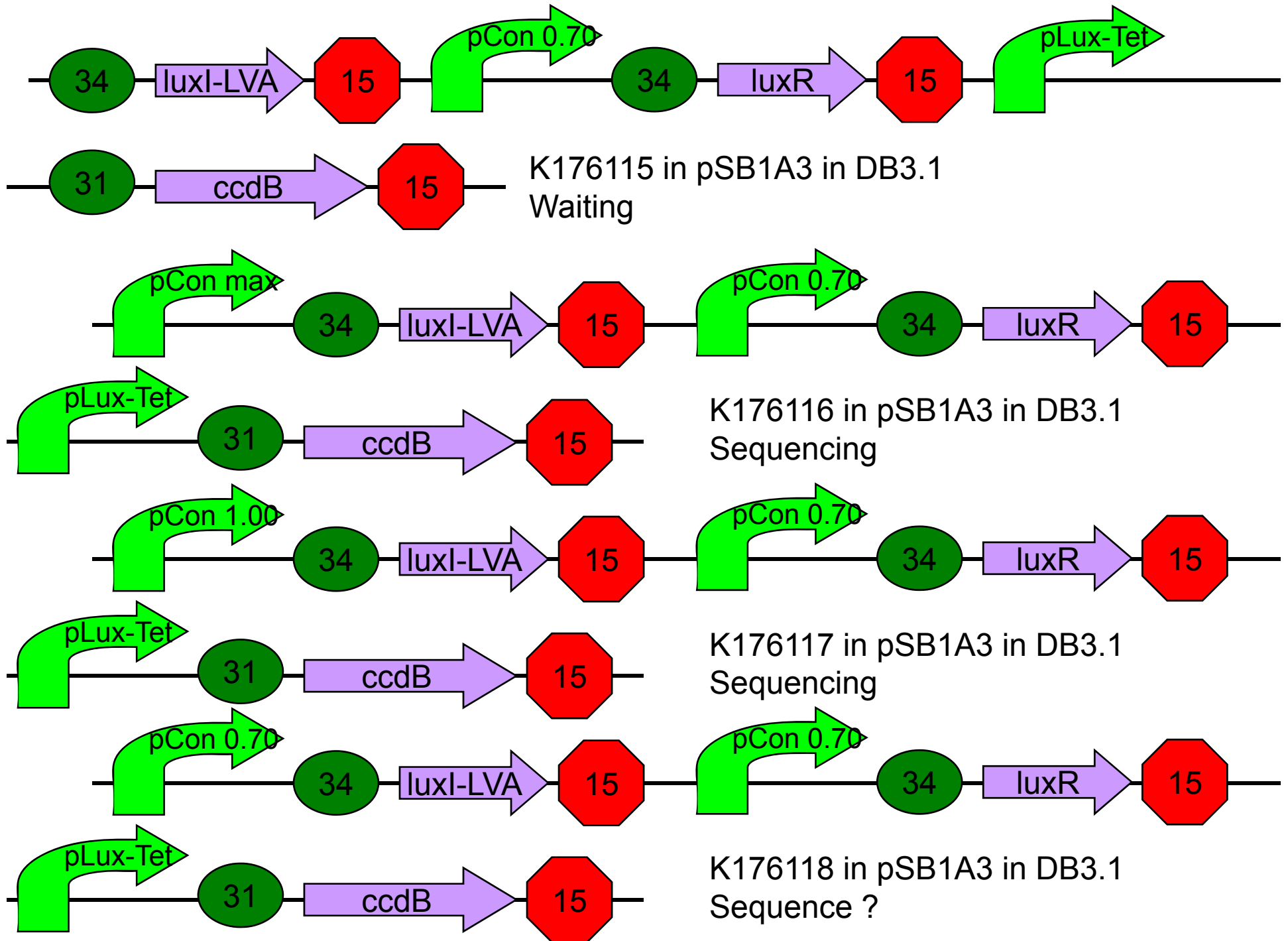

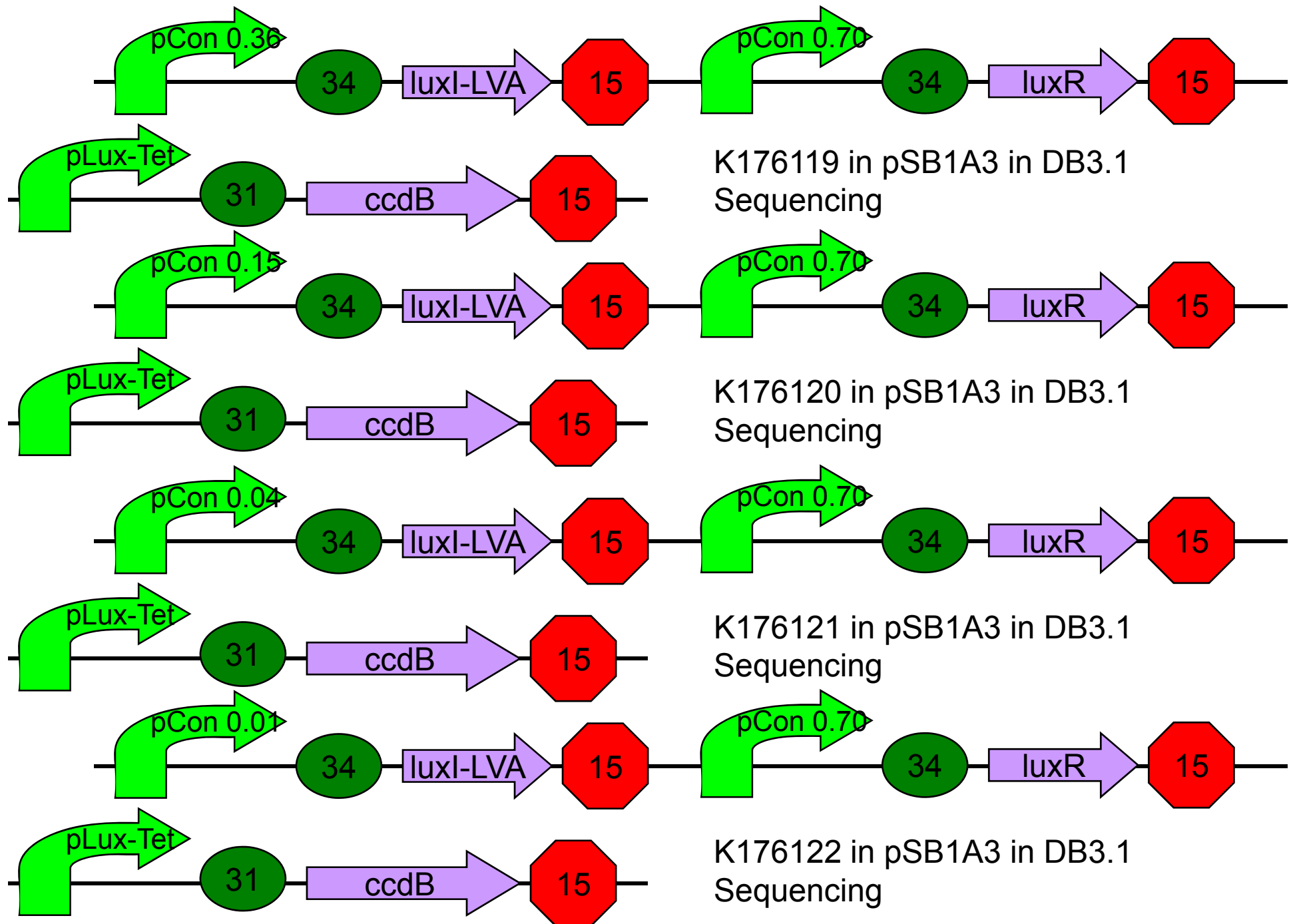

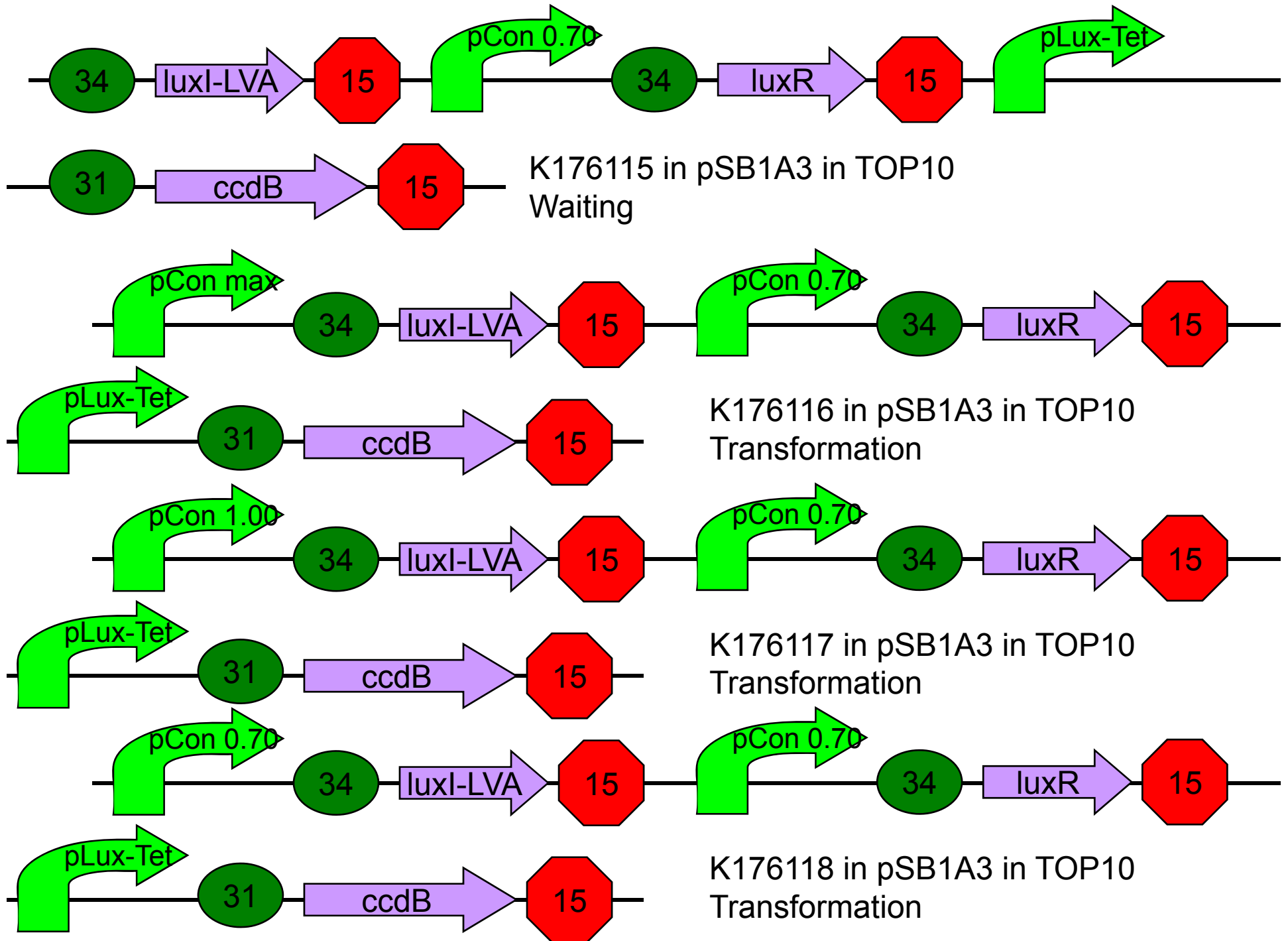

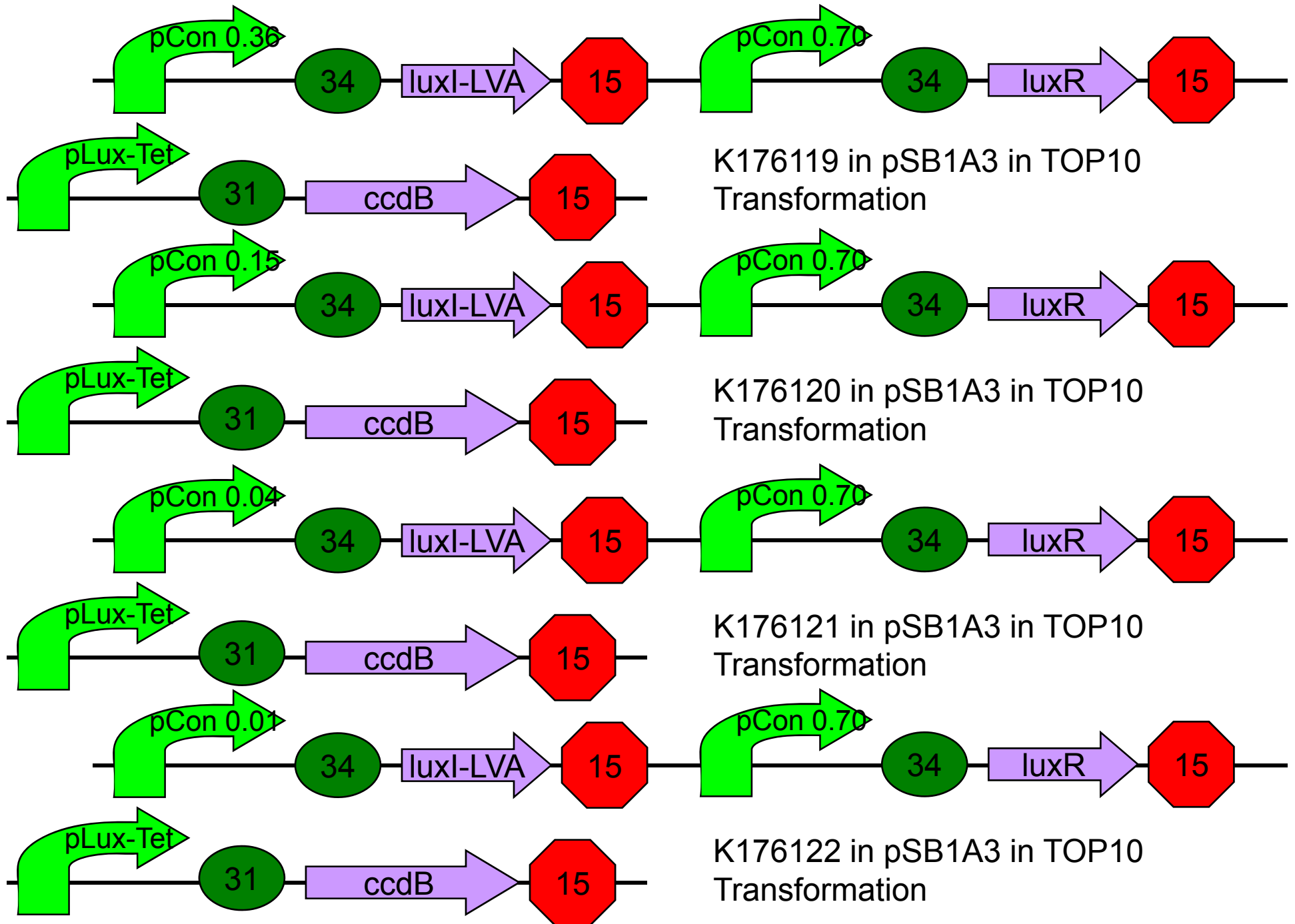

15

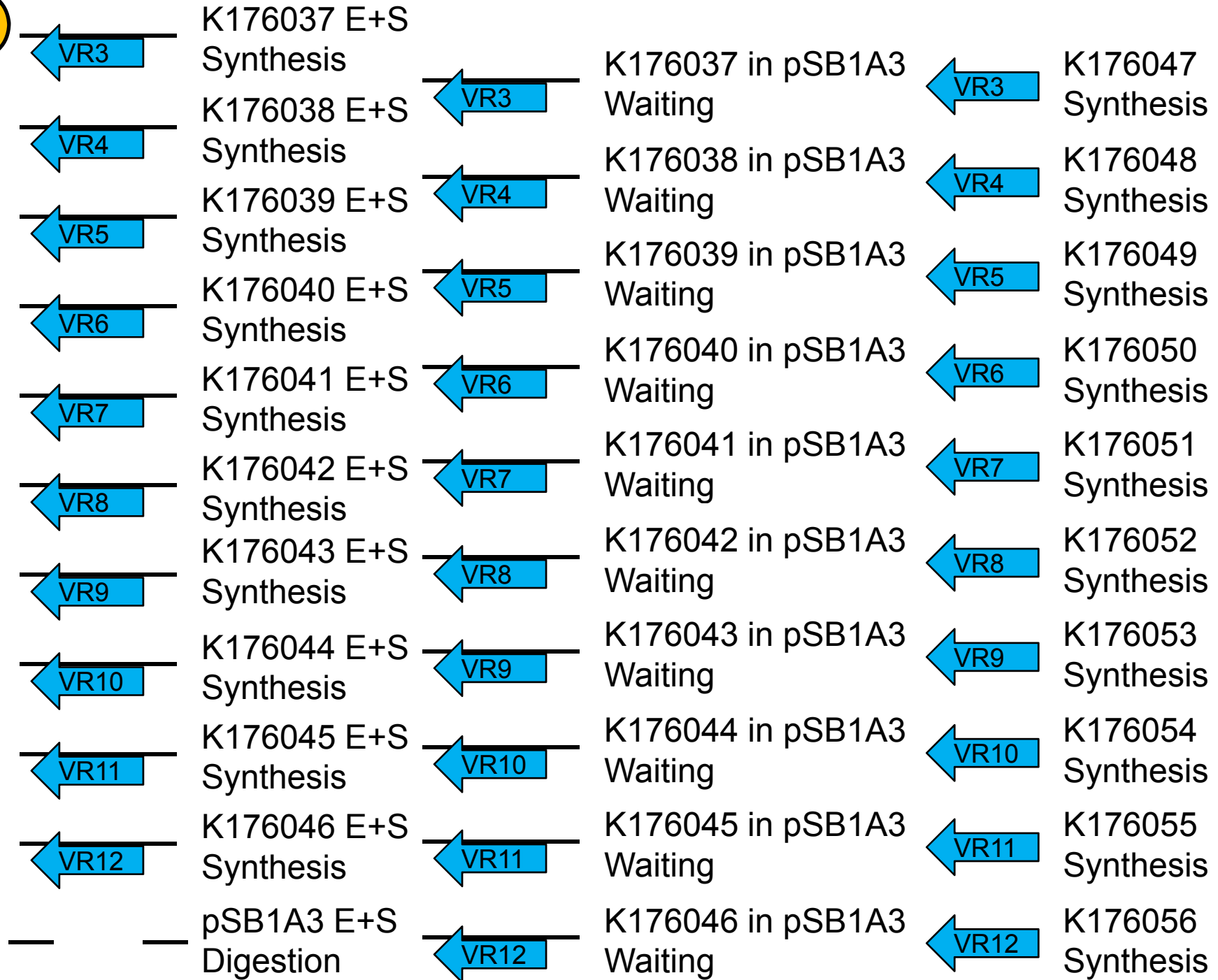



16

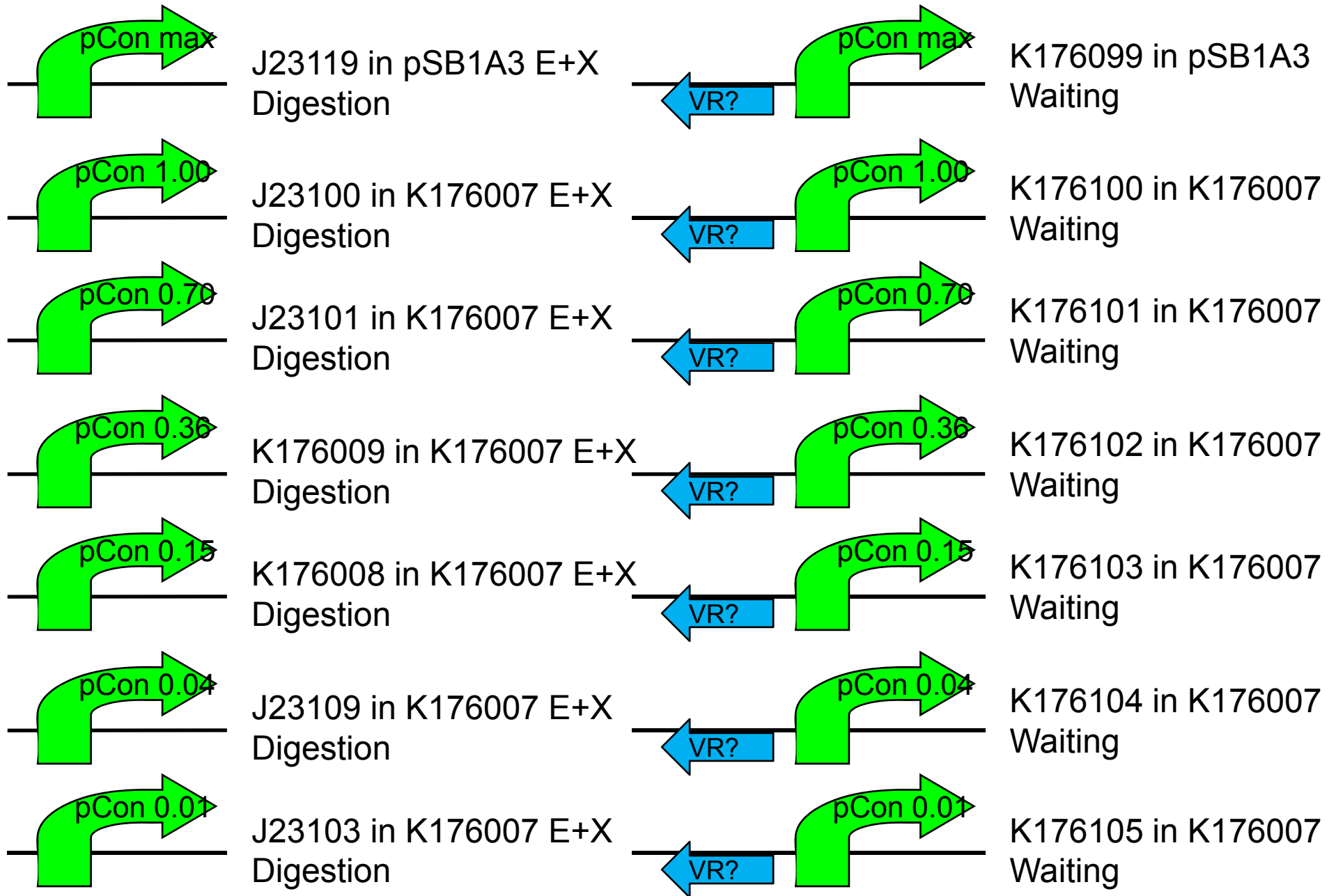

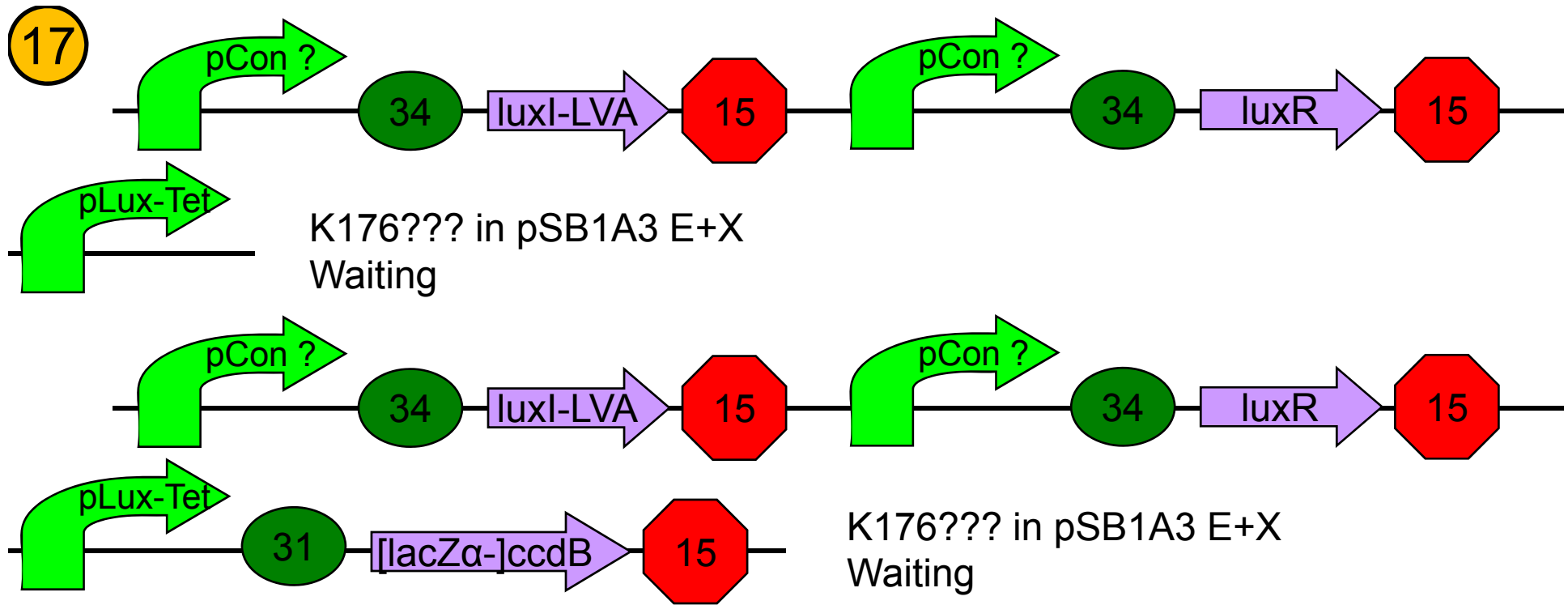

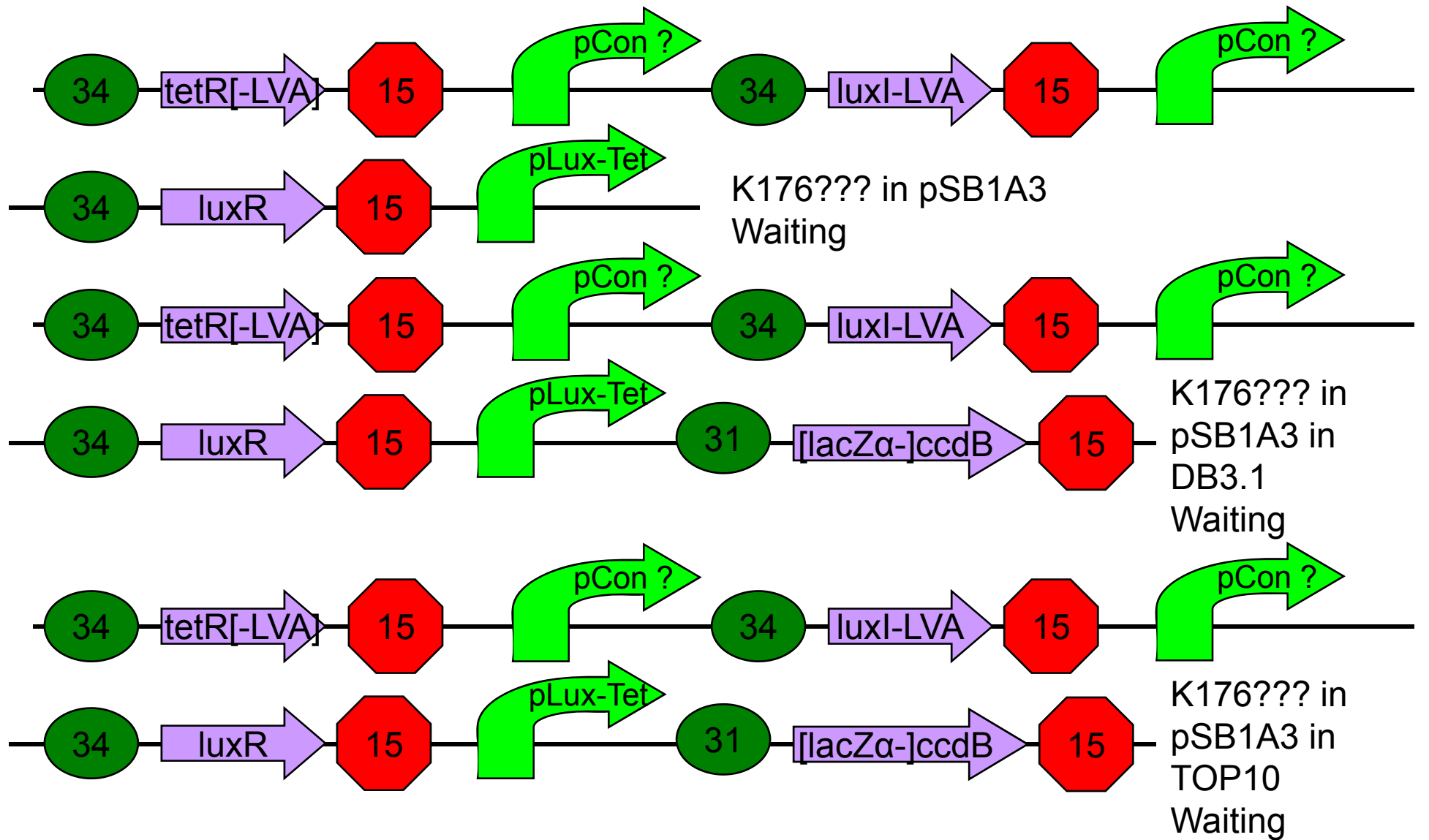

18

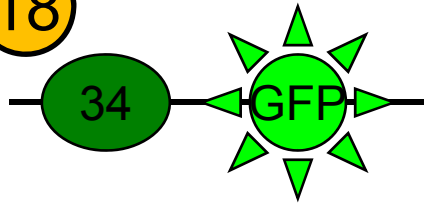

I13500 in pSB1A2  
Sequence OK

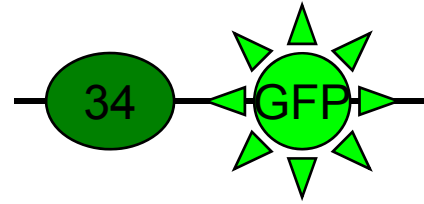

I13500 in pSB1A2 S+P  
Length OK

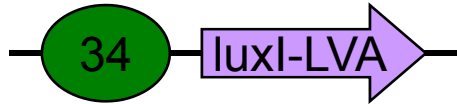

C0261 in pSB1A2  
Sequence OK

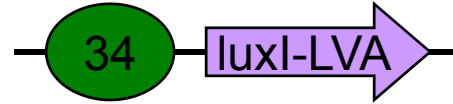

C0261 X+P  
Length OK

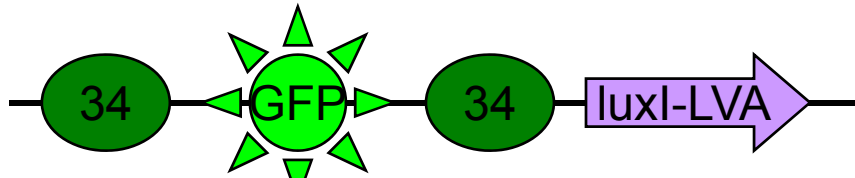

K176106 in pSB1A2  
Sequence OK

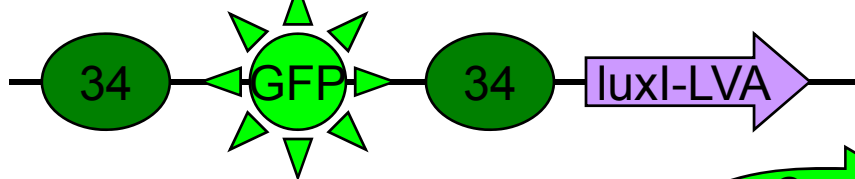

K176106 E+S  
Digestion

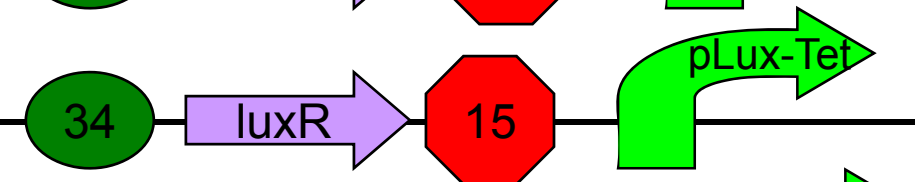
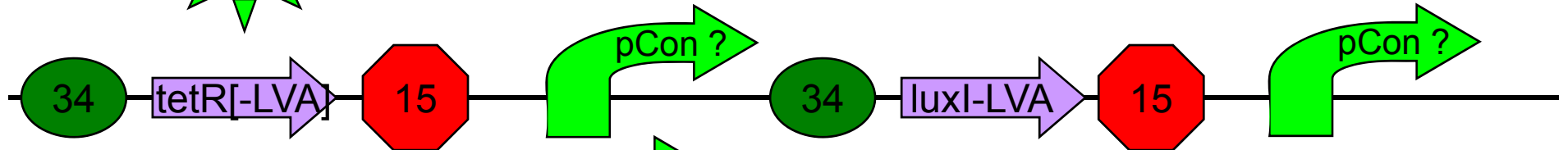

K176??? in pSB1A3 S+P  
Waiting

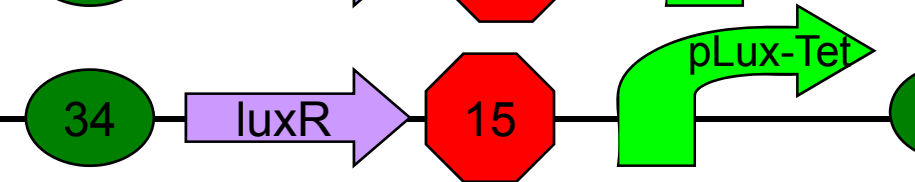
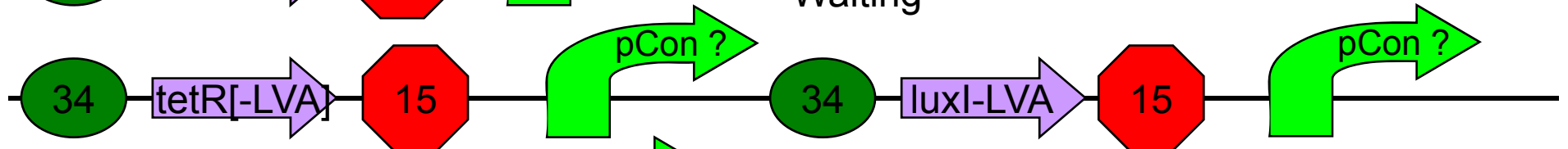

K176??? in pSB1A3 S+P  
Waiting

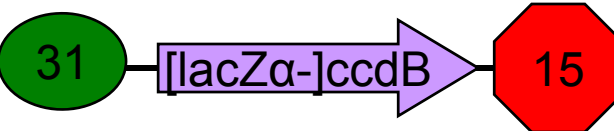

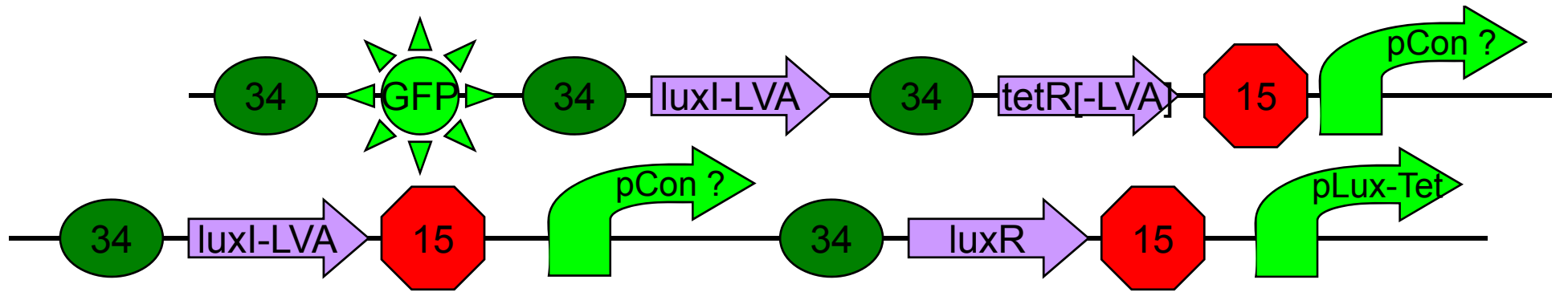

K176??? in pSB1A3  
Waiting

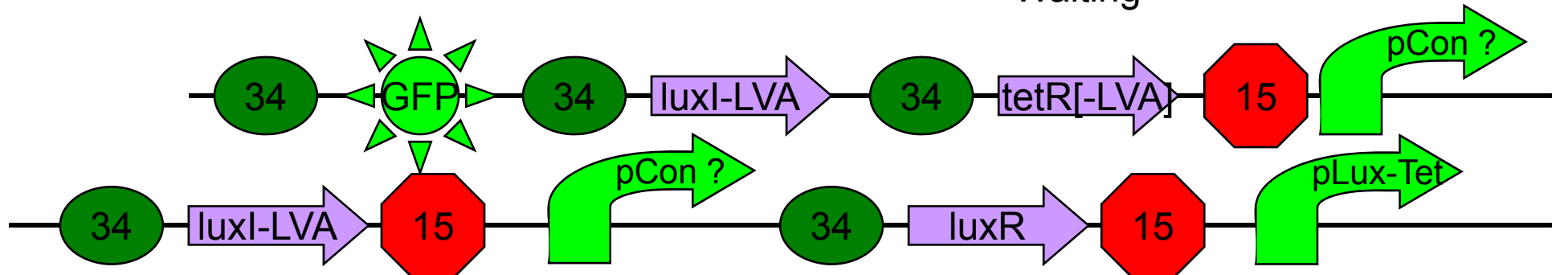

K176??? in pSB1A3 in DB3.1  
Waiting

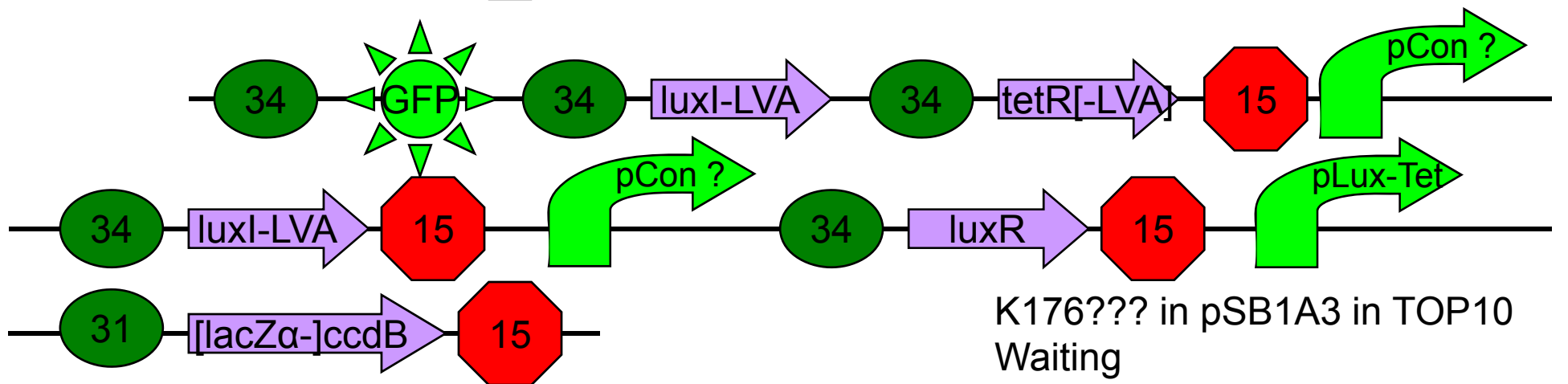

K176??? in pSB1A3 in TOP10  
Waiting





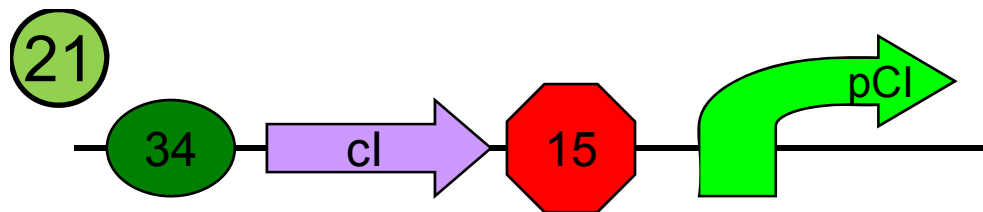

Q04510 in pSB2K3  
Sequence OK



22

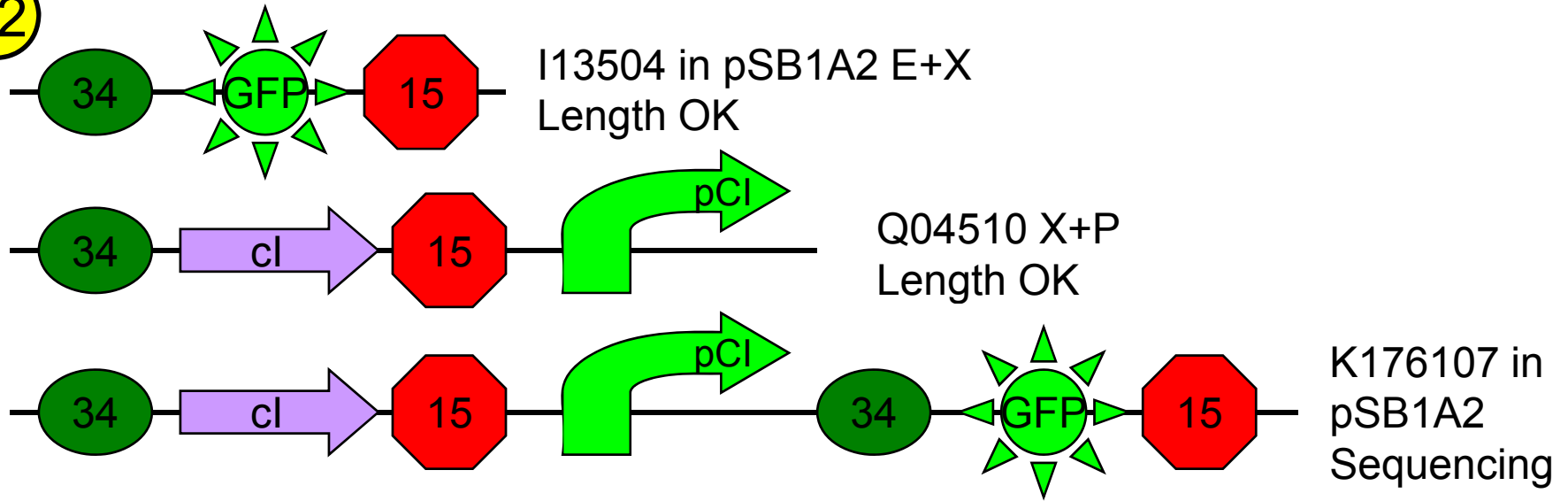

23

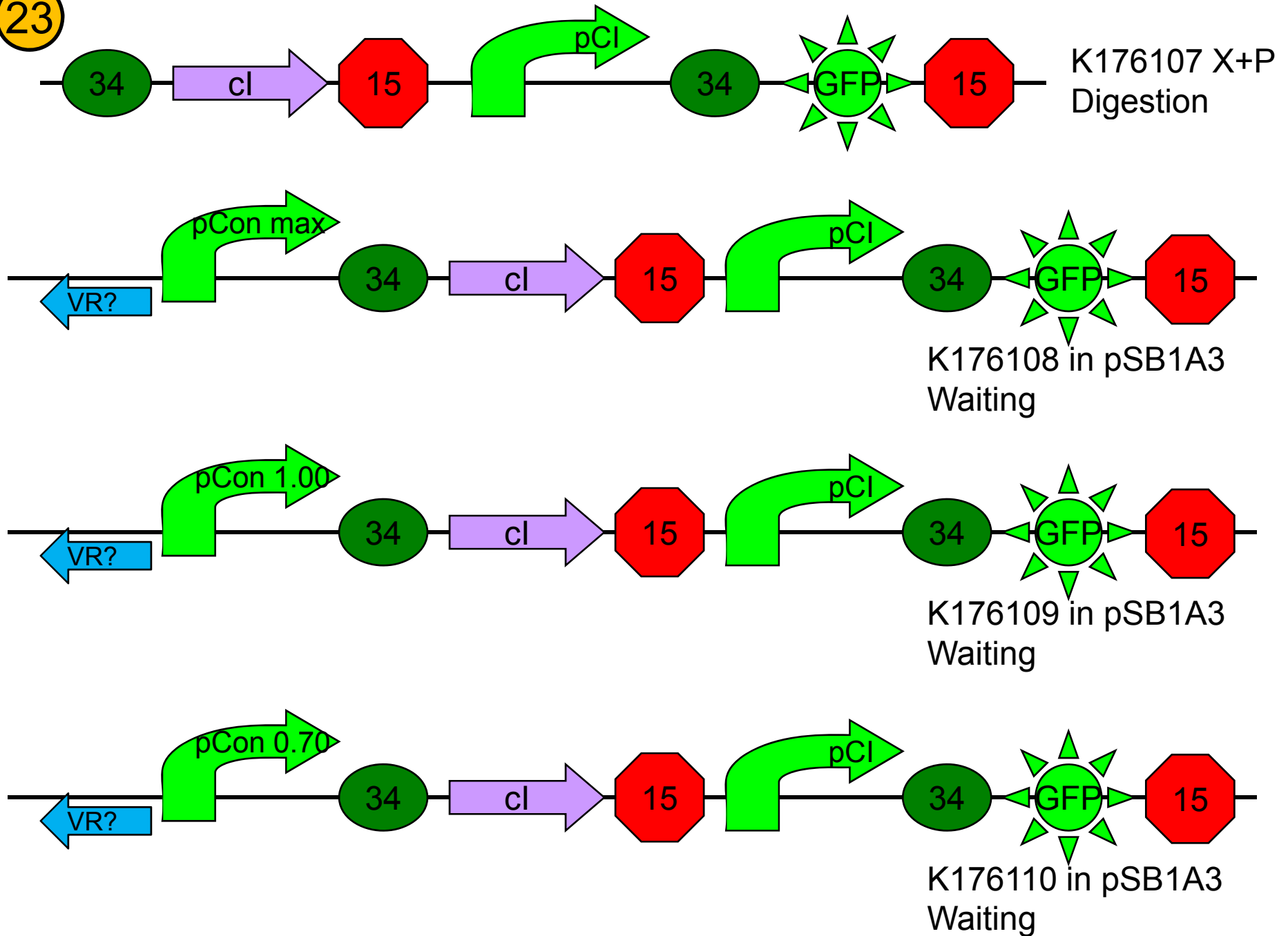

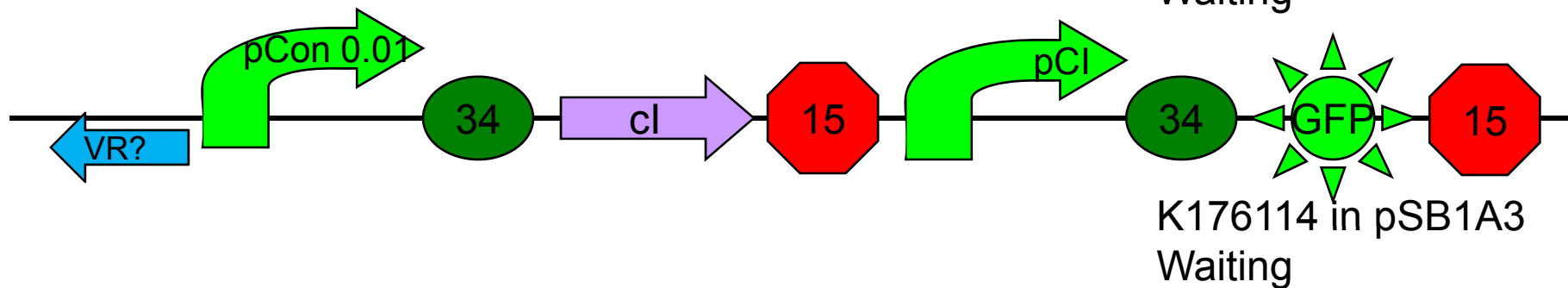
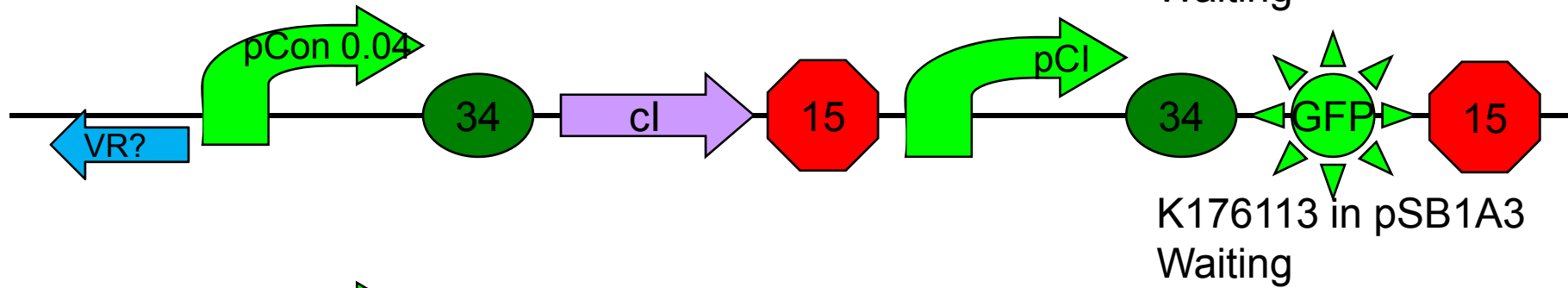
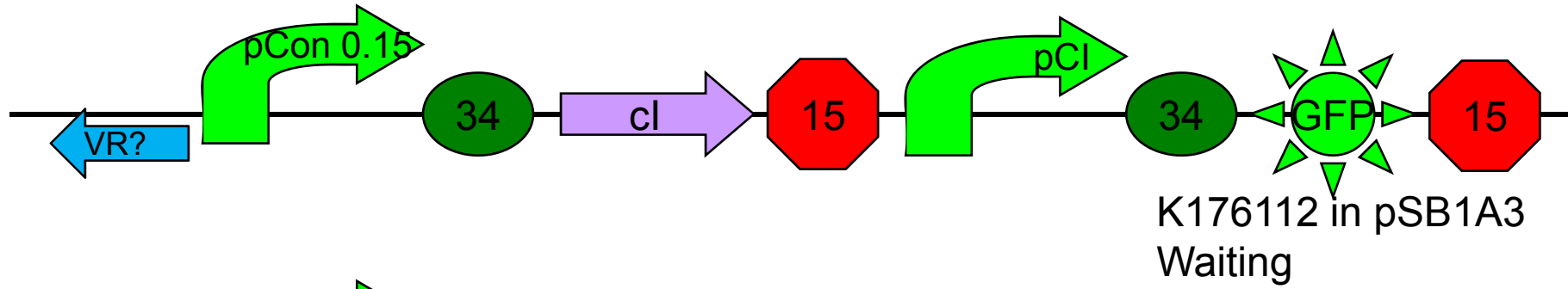
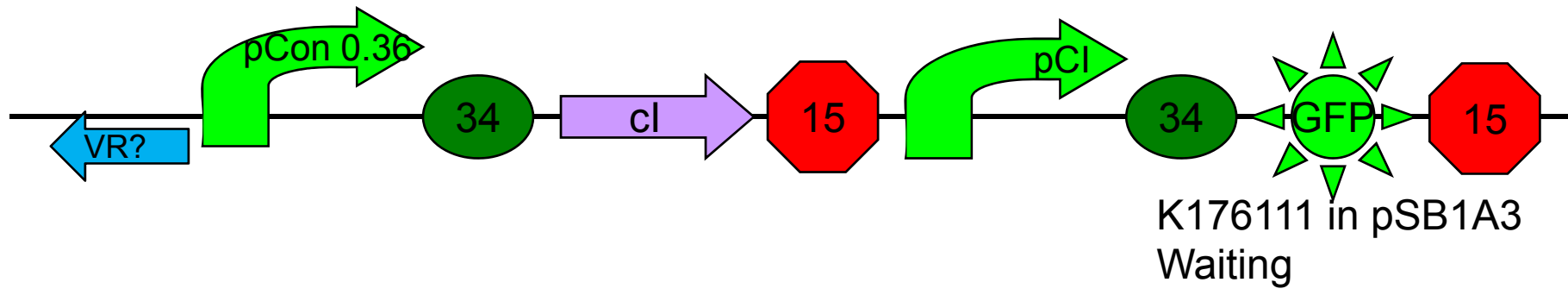

# Measurement

- Strain
  - TOP10
  - DH5 $\alpha$
  - MG1655
  - MDS 42 recA Blue
- Plasmid
- Medium
  - LB
  - M9
    - Minimal
    - Supplemented
  - EZ Rich Define
  - pH-buffered TBK
  - pH-buffered LBK
- pH
- Temperature
  - 37°C
  - 30°C
  - 34°C
- Pre-warm
- Shake
- Dilution
- Wash

# Wiki

- Team project description
- Notebook
  - Meetings
  - Lab Work
  - Sample Naming Sheets
- Logo
- Team
- Other pages

Thank You