

E. coli Automatic Directed
Evolution Machine (E.ADEM)

v0.0.6.0

2009.10.10

2009.5.3

159 days

2009.10.10

10 days

2009.10.21

8 days

2009.10.30

Calendar of Events

IGEM 2009 Calendar of Events

Note: Dates in grey have not been finalized yet. Make sure to check the calendar periodically for any changes!

- 19 February** IGEM 2009 registration opens
- 31 March** IGEM 2008 registration closes; Team registration fee due
- 13 May** DNA Distribution sent to teams (**target deadline; subject to change**)
- 16/17 May** [iGEM Workshop, MIT, USA](#)
- 1 June** [Visa invitation letter](#) requests due
- 20/21 June** [iGEM Workshop, Europe](#)
- 27/28 June** [iGEM Workshop, Asia](#)
- 15 June** Preliminary team rosters due
- 1 August** Team project descriptions due
- 18 September** [Jamboree attendance fee](#) due
- 18 September** [Request for variance](#) due (notice and description of any use of non-standard parts or devices schemes due)
 - [Track selection](#) due
 - [Project abstracts](#) due
 - [Team rosters](#) due
- 21 October** Project and part documentation due, including documentation for all medal criteria
 - BioBrick Part DNA needs to be received by the Registry
 - [Judging form](#) due
 - Wiki FREEZE at 11:59pm, EST
- 30 Oct - 2 Nov** iGEM Competition Jamboree, MIT, USA

Lots of Things to Do !

- Oct 21 Deadline
 - DNA submission
 - Documentation
 - Wiki
 - Data & Standard
 - Modeling
 - Diagram
 - Project
 - Notebook
 - Human practice
 - Team & Logo
- Parts
 - Judging form
- Pre-Jamboree
 - Team Spirit
 - T-shirt
 - Mascot
 - Poster
 - Presentation
 - Photo Release Form

Team Name:

USTC

Final Track Selection:

1. Foundational Advance
2. Information Processing
3. New Application

Project Name:

E. coli Automatic Directed Evolution Machine: a Universal Framework for Evolutionary Approaches in Synthetic Biology

Project Abstract:

Evolution is powerful enough to create everything, from biomolecules to ecosystems. The ultimate goal of *E. coli* Automatic Directed Evolution Machine (E.ADEM) project is to manage the power of evolution, by engineering a robust system framework that can automatically create anything we want in synthetic biology, from various types of parts to complex systems. Each demand can be converted into designing a scoring function to give the evolution process a direction. E.ADEM is designed by implementing evolutionary algorithm back into biology. The core of E.ADEM is a self-adaptive controller that can adjust variation rate and selection pressure, based on fitness score, population size and average fitness score calculated by a quorum sensing device. After comprehensive measurement using constitutive promoter family stimulus signals and modeling of the components, a prototype machine is built. Modular design and PoPS device boundary standard will ensure the extensibility and universality of the machine.

Jamboree/Project Abstract/Team Abstracts

Contents [hide]

- 1 Team Aberdeen_Scotland: A Synthetic Biology Approach to Pipe Repair: The Pico-Plumber
- 2 Team Alberta: A Synthetic Biology Tool Kit for Artificial Genome Design and Construction
- 3 Team ArtScienceBangalore:
- 4 Team Bay_Area_RSI: Breast cancer cell targeting phage
- 5 Team BCCS-Bristol: VESECURE
- 6 Team Berkeley_Software: Eugene, Spectacles, and Kepler: Managing Synthetic Biology Device Development
- 7 Team Berkeley_Wetlab: Automated assembly of cell surface display devices
- 8 Team BIOTEC_Dresden: Temporal and spatial control of protein synthesis by in vitro recombination inside picoliter reactors
- 9 Team Bologna: T-REX: Trans-Repression of Expression. A BioBrick gene-independent control of translation
- 10 Team British_Columbia: Development of a modular, analog E. coli biosensor
- 11 Team Brown: Engineering Staphylococcus Epidermidis to Secrete Recombinant Histamine Binding Protein in Response to Changing Histamine Concentration
- 12 Team Calgary: Reprogramming a Language and a Community
- 13 Team Cambridge: E. Chromi: Triggering Pigment Production in E. Coli
- 14 Team CBNU-Korea: Essarker: An Essential Remarker for a Minimal, Synthetic Genome
- 15 Team Chiba: E. coli Time Manager Since 2008
- 16 Team CityColSanFrancisco:
- 17 Team Cornell: Engineering the Bacillus Subtilis Metal Ion Homeostasis System to Serve as a Cadmium Responsive Biosensor
- 18 Team DTU_Denmark: The redoxilator, and the USER fusion assembly standard
- 19 Team Duke: One-Step Construction of a Bioplastic Production Pathway in E. coli
- 20 Team Edinburgh: Defusing a dangerous world: a biological method for detection of landmines
- 21 Team EPF-Lausanne: E. Colight
- 22 Team Freiburg_bioware: Universal endonuclease – cutting edge technology
- 23 Team Freiburg_software: SynBioWave – A Collaborative Synthetic Biology Software Suite
- 24 Team Gaston_Day_School: Development of a Red Fluorescent Nitrate Detector
- 25 Team Groningen: Heavy metal scavengers with a vertical gas drive
- 26 Team Harvard: Interspecies Optical Communication Between Bacteria and Yeast
- 27 Team Heidelberg: Spybricks - a starter kit for synthetic biology in mammalian cells
- 28 Team HKU-HKBK: Biomotor
- 29 Team HKUST: SynBiological Bug Buster
- 30 Team IBB_Pune: Constructing multi-strain computational modules using Nucleotide and Protein mediated cell-cell signaling.
- 31 Team IGIB-Delhi:
- 32 Team IIT_Bombay_India: Analysis of multiple feedback loops using Synthetic Biology
- 33 Team IIT_Madras: PLASMID: Plasmid Locking Assembly for Sustaining Multiple Inserted DNA
- 34 Team Illinois: Bacterial Decoder
- 35 Team Illinois-Tools: Interactive Metabolic Pathway Tools
- 36 Team Imperial College London: The E.ncapsulator
- 37 Team Indiana: Introduction of DNA and protein into plants

- 37 Team Indiana: Introduction of DNA and protein into plants
- 38 Team IPN-UNAM-Mexico: Turing meets synthetic biology: self-emerging patterns in an activator-inhibitor network.
- 39 Team IPOC1-Colombia: Molecular Device to Detect Sea Salinity
- 40 Team IPOC2-Colombia: Molecular Device that Biodegrades Pesticides
- 41 Team Johns_Hopkins-BAG: Synthetic yeast genome Sc2.0 and Build-A-Genome
- 42 Team KU_Seoul: Integrated Heavy Metal Detection System
- 43 Team KULeuven: Essencia coli, the fragrance factory
- 44 Team Kyoto: Time Bomb & Cells in cells
- 45 Team LCG-UNAM-Mexico: Fight fire with fire: phage mediated bacterial bite back
- 46 Team Lethbridge: A Synthetic Future: Microcompartments, Nanoparticles and the BioBattery
- 47 Team McGill: Activation-inactivation signaling in one-and two-dimensions
- 48 Team METU-Gene: A Fast Healing Mechanism; Wound Dressing
- 49 Team Michigan: The Toluene Terminator
- 50 Team Minnesota: Computational synthetic biology: How the Synthetic Biology Software Suite can guide wet-lab experiments
- 51 Team Missouri_Miners: A Synthetic Biology Approach to Microbial Fuel Cell Development Utilizing E. Coli
- 52 Team MIT: Photolocalizer
- 53 Team MoWestern_Davidson: Rolling Clones: Can't get no SATisfaction
- 54 Team NCTU_Formosa: Bacterial referee with the adjustable timer and counter functions
- 55 Team Nevada: Cinnamicide: Producing a Natural Insecticide against Mosquito Larvae in E. coli and Duckweed
- 56 Team Newcastle: Bac-man: sequestering cadmium into Bacillus spores
- 57 Team NTU-Singapore: Plaque Out!
- 58 Team NYMU-Taipei: ViroCatcher
- 59 Team Osaka: ColorColi: Painting tools toward bio-art
- 60 Team Paris: Message in a Bubble: a robust inter-cellular communication system based on outer membrane vesicles.
- 61 Team PKU_Beijing: Conditioned Reflex Mimicking in E.coli
- 62 Team Purdue: Engineered Microglia to Locate CD133+ Tumor-Initiating Cells
- 63 Team Queens: Plaque Busters: A Synthetic Biology Approach to Targeted Drug Delivery Treatment of Atherosclerosis
- 64 Team SDU-Denmark: Bacto Bandage - Quorum-quenching S. Aureus Biofilm Formation, One Peptide at a Time
- 65 Team Sheffield: E. Coli Switch
- 66 Team SJTU-BioX-Shanghai: Hypnos' Curse: E.coli the napper
- 67 Team Slovenia: nanoBRICKsPRO – synthetic smart nanomaterials from nano to macro
- 68 Team Southampton: E.coli YMPIC GAMES
- 69 Team Stanford: Immuni-T. coli: A Probiotic Approach to Diagnosing and Treating Inflammatory Bowel Disease (IBD)
- 70 Team SupBiotech-Paris: Double vectorisation system (DVS)
- 71 Team Sweden: The Linguistic Cell: Sentence Parsing Bacteria
- 72 Team Tianjin: Cyanobacteria convertor & Microcystins detector
- 73 Team Todai-Tokyo: Prevention of Lifestyle Diseases Using Synthetic Organisms
- 74 Team Tokyo_Tech: 2009 Space Odyssey: Terraforming of Mars with genetically engineered bacteria
- 75 Team Tokyo-Nokogen: Escape tedious work with Escherichia coli Auto Protein Synthesizer (ESCAPES).
- 76 Team TorontoMaRSDiscovery: Engineering bacterial micro-compartments to investigate metabolic channeling and its potential uses in biotechnological applications
- 77 Team Tsinghua: Syn-genome Based Gensniper

- // Team I singnua: Syn-genome Based Gensniper
- 78 Team TUDelft: Bacterial Relay Race
- 79 Team TzuChiU_Formosa: Midnight Apollo
- 80 Team UAB-Barcelona: A toxics biosensor. Could bacteria detect instantaneous and simultaneously several types of pollutants?
- 81 Team UC_Davis: A Bacterial Secretion System Motivated the Goal of Managing Celiac
- 82 Team UChicago: An enhanced yeast-based system for detection and decontamination of organophosphate neurotoxins.
- 83 Team UCL_London: Stress Light
- 84 Team UCSF: Engineering the Movement of Cellular Robots
- 85 Team ULB-Brussels: GluColi, a new generation of glue
- 86 Team UNICAMP-Brazil: The Microguards
- 87 Team UNIPV-Pavia: Ethanol? Why not!
- 88 Team uOttawa: A probiotic Lactobacillus strain which produces cellulose
- 89 Team Uppsala-Sweden: Booze Bugs : Sun To Alcohol
- 90 Team UQ-Australia: Mercury sequestration using a multicomponent operon, and increasing the temperature tolerance range of *P. syringae*.
- 91 Team USTC: E. coli Automatic Directed Evolution Machine: a Universal Framework for Evolutionary Approaches in Synthetic Biology
- 92 Team USTC_Software: Automatic Biological Circuit Design
- 93 Team Utah_State: BioBricks without Borders: Investigating a multi-host BioBrick vector and secretion of cellular products
- 94 Team Valencia: iLCD: iGEM Lighting Cell Display
- 95 Team Victoria_Australia: An environmentally sustainable biological lighting system
- 96 Team VictoriaBC: Signal Integration: Applications of RNA Riboregulator Capabilities
- 97 Team Virginia: Arsenic Sequestration for Groundwater Decontamination
- 98 Team Virginia_Commonwealth: Promoter design, characterization and consequences
- 99 Team Warsaw: BacInVader – a new system for cancer genetic therapy
- 100 Team Wash_U: Improved Photosynthetic Productivity for Rhodospirillum rubrum via Synthetic Regulation of the Light Harvesting Antenna LH2
- 101 Team Washington: The Ideal Protein Purification System
- 102 Team Washington-Software: LegoRoboBricks for Automated BioBrick Assembly
- 103 Team Waterloo: Chromobricks: A Platform for Chromosome Engineering with BioBricks
- 104 Team Wisconsin-Madison: Ocean Fuel: increased salt tolerance through glycine betaine production
- 105 Team Yeshiva_NYC: Spatially encoding temporal information: using diffusional escape of periplasmic reporter proteins as a clock.

Team Aberdeen_Scotland: A Synthetic Biology Approach to Pipe Repair: The Pico-Plumber

[\[edit\]](#)

Damage to inaccessible pipe systems, such as computer cooling circuits, is difficult to rectify. An *Escherichia coli* synthetic biology circuit for pipe repair was designed. Pipe breach detection and the restoration of pipe integrity were implemented through exploitation of chemotaxis, and cell lysis that releases a two-component protein-based glue (lysyl oxidase and tropoelastin). Control was achieved using an AND gate with quorum sensing and the lac inducer IPTG (released from the breach) as inputs. Deterministic and stochastic models of the genetic circuit, integrated with an agent-based model of *E. coli* cells, were used to define the effective radii of cell migration and timing of lysis. Constructed AND gate, quorum sensing and lysis timing modules were experimentally tested. The two-component glue concept was successfully validated using in vitro alpha-omega complementation of beta-galactosidase activity. Finally, a proposal for an igem.org-based parameter database was developed to aid the rapid identification of BioBricks parameter values.

Team Alberta: A Synthetic Biology Tool Kit for Artificial Genome Design and Construction

[\[edit\]](#)

The creation of simplified artificial cells with specialized functions, along design principles that are compatible with the goals of synthetic biology, requires advances in

IGEM 2009 Team Information

Team Name:	USTC
Primary Contact:	Zhaofeng Luo
Schools:	University of Science and Technology of China Hefei, Anhui, P.R. China www.ustc.edu.cn
Description:	University of Science and Technology of China iGEM 2009 wetlab team

Registration Status

- ✓ Your iGEM 2009 team registration has been accepted by iGEM Headquarters. Welcome to iGEM 2009.
- ✓ DNA Kit of Parts shipping information has been entered, thanks. [View shipping information](#)
- ✓ Resource description has been submitted, thanks. [View resource description](#)
- ✓ Your registration fee has been received. Thank you. [More...](#)

Team Roster

Instructors

smilesun	Zhaofeng Luo	lzf@ustc.edu.cn
ZhanJian	Zhan Jian	zhanjian@ustc.edu
JiongHong	Jiong Hong	hjiong@ustc.edu.cn
XiaoxiaoMa	Xiaoxiao Ma	mx0208@mail.ustc.edu.cn

Student Members

horigen	Hao Jiang	haojiang@mail.ustc.edu.cn
Cherrytree	Jiayi Dou	cherrytrees_dot@hotmail.com
xingli	Li Xing	xingli1@mail.ustc.edu.cn
Horton	Hanyu Lu	henrylu@mail.ustc.edu.cn
Emma	Hao Wu	wuhao86@mail.ustc.edu.cn
Ich2009	Chao Li	randylch@mail.ustc.edu.cn
dianazhou	Hao Zhou	dianazh@mail.ustc.edu.cn
dqliu	Danqian Liu	dqliu93@mail.ustc.edu.cn
wub	Bing Wu	wub@mail.ustc.edu.cn
zxhe	Zongxiao He	zxhe@mail.ustc.edu.cn

Advisors

JiaruiWu	Jiarui Wu	wujr@sibs.ac.cn
HaiyanLiu	Haiyan Liu	hyliu@ustc.edu.cn

This range of part numbers has been assigned to your team for use during the summer: BBa_K176000 to BBa_K176999

iGEM 2009

International Genetically Engineered Machine Competition

Receipt

Print

Email

Registration ID: 20108107

Registration Date: September 18, 2009

Receipt Date: September 18, 2009

Issued By: MIT Conference Services

Event: iGEM 2009 - Jamboree Registration

Date/Time: Friday, October 30, 2009 - Monday, November 02, 2009

The following are registered for the event:

Registration ID	Name	Type
20108107	Hao Jiang	Team Member
20108162	Jiayi Dou	Team Member
20108183	Chao Li	Team Member
20108206	Danqian Liu	Team Member
20108223	Zongxiao He	Team Member
20108245	Bo Ding	Team Member
20108309	Wei Pan	Team Member
20108316	Yuwei Cui	Team Member
20108333	Jiahao Li	Team Member
20108342	Yu He	Team Member

Billed To:

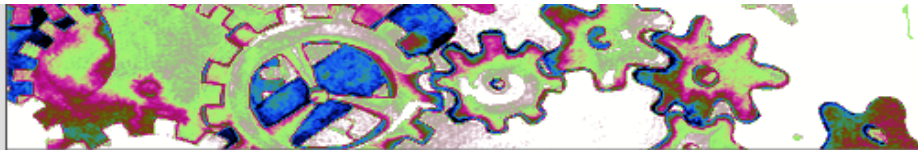

DNA Submission Instructions

Click [here](#) to access the Online DNA Submission form.

Contents [\[hide\]](#)

- [1 New DNA Submission](#)
- [2 Sample Information](#)
- [3 Shipment information](#)
- [4 Shipping Instructions](#)
- [5 Notes](#)

New DNA Submission [\[edit\]](#)

When you come to the DNA Submission main page, you will be able to "start a new DNA submission" or "see your DNA submissions." To begin the submission process click on "start a new DNA submission."

DNA Submissions

[-> DNA Submissions](#) [-> My Batches](#)



You have designed some new parts, entered them in the Registry and are ready to send the DNA. These pages will help you prepare a batch of parts to send to the registry. They will allow you to track their progress as we receive them and run them through our quality control process.

[Detailed instructions](#)

[Start a New DNA Submission Now](#)

[See Your DNA Submissions Now](#)

On this page that you must enter information about yourself as the user submitting the DNA. Please make sure that the username and full name that we have listed for you is correct. You then need to choose which team you are on (also called a group). Correct your email if necessary and do not forget to enter your phone number.

We have this user name for you: 'meaganl' and this full name: 'Meagan Lizarazo'

Which of your groups is sending the DNA?

We have this email address for you. Please correct it if necessary:

Please enter your phone number:

You must tell us in what format you are sending your DNA. Choose a format from the menu and indicate how many samples you are sending. Click [here](#) for more information about the accepted formats. You should also let us know if there are any special instructions that we must know about.



outbreaks recently, so don't label your DNA E.coli.) Second, plasmid DNA is more stable than stab. Finally, we want to have the parts in our standard strains as part of our input quality control process.

The Plasmid DNA may be sent in:

- Labeled Single PCR Tubes
- 8-Tube Strips
- 96-Well Plates
- Spots on Filter Paper Grids

Single PCR Tubes



20ng DNA in 10ul TE minimum

Wrap tube in lab tape and label with tube number

Cap tube tightly

Ship in a 50ml Falcon tube labeled with your team name and Order #

Note: The largest problem with single PCR Tubes is trouble reading the label. You can write on the tube in smaller print than we can read reliably. Furthermore, the markings on tubes are often smeared. So, please use a long piece of lab tape all the way around the tube. Fill out the on-line DNA Submission form and write the tube number on the tab of the tape. Use a ball point pen or a permanent marker.

8-Tube Strip



20ng DNA in 10ul TE minimum

Wrap first tube in lab tape and label with tube number(e.g. #1, #9, #17, etc)

Cap tightly

Ship 8-tube strips inside a 50ml Falcon tube (two 8-tube strips per tube) labeled with your team name and Order #

96-Well Plate

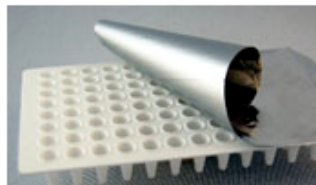

20ng in 10ul TE minimum

Fill in the online DNA Submission form first

Add DNA to the wells in the order 1A, 1B, 1C, ... that is down first then across

Cover tightly with aluminum foil adhesive cover (e.g. Axygen PCR-AS-200)

Paper Grid



The Registry sent out paper grids that can be used to send dry DNA. Please follow the [instructions on that paper](#).

Fill out the online DNA Submission form first.

Be sure to fill out the form on the paper. Be particularly careful to print the Submission Number from the online form on the paper form.

	1	2	3	4	5	6	7	8	9	10	11	12
A												
B												
C												
D												
E												
F												
G												
H												



Fold #1 Here

Please avoid touching the grid with your hand or arm as you fill out this page.

Directions

- Mix 0.4 μL 1% Cresol Red with 1.6 μL DNA (your sample should be at a concentration of at least 100 ng/ μL).
- Place the grid on top of a clean piece of paper. Spot 2 μL in the center of each box. Start at 1A and work your way down each column as you add additional parts.
- Leave spots to dry at room temperature for 1 hour. Make sure the spots are protected from contamination by dust, dirt and aerosols.
- Fill out the form below.
- In order to protect the DNA grid, fold the top third of this page down, the bottom third up, put in an envelope, and mail to Meagan Lizarazo at:
M.I.T.
32 Vassar Street, Room 32-314
Cambridge, MA, 02139
meaganl@mit.edu
+1.617.258.5244
- Fill out the online submission form (Instructions at parts.mit.edu/igem07).



Fold #2 Here

Please fill in the following fields prior to sending the DNA to the Registry

Submission Number: _____

iGEM Team or Lab: _____

Prepared By: _____ Email: _____

Number of Spots: _____

Average amount of DNA (ng) per spot: _____

Date: _____

What format will you be sending?

Single Tubes
 8-Tube Strip
 96-Well Plate
 Paper Grid

Keep in mind that there are specific DNA amount requirements that you must follow.

For single PCR tube:

- 20ng in 10ul volume (2ng/ul) minimum needed
- Wrap tube in lab tape and label with tube number
- Cap tightly and ship in 50ml Falcon tube

For 8-tube strips:

- 20ng in 10ul volume (2ng/ul) minimum needed
- Cap tightly
- Wrap 1st tube on each 8-tube strip with lab tape and write the correct tube number (e.g. # 1, 9, 17 etc.) with a permanent marker on the tape
- Ship 8-tube strips inside a 50ml Falcon tube (2 8-tube strips per 50ml Falcon tube)

For 96-well plate:

- 20ng in 10ul volume (2ng/ul) minimum needed
- Add DNA to wells in the order of down row 1, down row 2, etc. (i.e. #1 = 1A, #2 = 1B, #3 = 1C, #4 = 1D, #5 = 1E, #6 = 1F, #7 = 1G, #8 = 1H, #9 = 2A, #10 = 2B, etc.)
- Cover tightly and carefully with aluminum foil adhesive cover (e.g. Axygen PCR-AS-200).

For filter paper grid:

- Spot at least 160ng DNA onto middle of each square, going down each row in order from left to right (follow the instructions printed on the grid).
- Fill out the online submission form as well as the paper submission form (with the grid and instructions on how to send the DNA in using this format)
- Remember to carefully fold the filter paper grid according to the instructions provided on the filter paper.

Proceed to entering sample information by clicking on the button at the bottom of the page.

[Proceed to create the new DNA submission and enter sample information](#)

Sample Information

[\[edit\]](#)

At the top of the sample information page you will see your Shipment #. You will need to remember this number, in particular if you are sending your DNA in filter paper grid format. In this case the shipment # needs to be written clearly on the filter paper grid form.

Shipment: 00029 User: Meagan Lizarazo For Group: iGEM_Registry	Format:  Paper Grid 1 Samples
---	--

Samples:

1 Samples

Samples:

Loc	Part	Plasmid	Resistance	Notes
1A	<input type="text"/>	<input type="text"/>	<input type="text"/>	<input type="checkbox"/> Toxic to Top-10 Cells <input type="checkbox"/> Sending plasmid not part <input type="checkbox"/> No part or plasmid (explain in comments) <input type="checkbox"/> Sequenced

Comments: [Cancel](#) [Save](#)

Begin to enter the information for your first part, beginning with the part number. You must enter the plasmid that the part is in. Note that the software will only recognize plasmids that are documented in the Registry so if you haven't added your plasmid to the Registry you must do so before submitting your parts. See the "Notes" section below for more details on plasmid information.

Once you have entered the part number and plasmid for your part, you can tab over to the antibiotic resistance field. The software will automatically fill in the antibiotic resistance based on the plasmid that you have entered. Please check to make sure that the resistance is correct. You may change it manually if it is not correct. The antibiotic abbreviation is the first letter of the antibiotic.

Please check any of the boxes that apply to your part if:

1. It is toxic to Top10 cells,
2. You are only sending a plasmid,
3. It is not a part or plasmid
4. Your team has sequenced this part

We need to know specifically whether your part is toxic to Top10 cell strain because it is our standard strain. We will be transforming all parts into Top10 and we need to know in advance whether this will be a problem with any of your parts. If you are sending us a plasmid, you need to check the appropriate box (see below for more plasmid information).

Please let us know by checking the box if you or your team has sequenced this part. This is **not** a box to have your part sequenced. At the moment we will not be collecting any sequence data or trace files but at some point in the future we will enable this feature. Please save all of your sequencing data in the event that you would like to add that information at a later date.

At this point you may add any notes that you may want to communicate with the Registry regarding your part in the comments field.

Tube	Part	Plasmid	Resistance	Notes
1	<input type="text"/>	<input type="text"/>	<input type="text"/>	<input type="checkbox"/> Toxic to Top-10 Cells <input type="checkbox"/> Sending plasmid not part <input type="checkbox"/> No part or plasmid (explain in comments) <input type="checkbox"/> Sequenced

Comments: [Cancel](#) [Save](#)



Once you have finished adding all of the information for your part, **click on the "save" link** and then "add another sample" button and proceed to filling out all the information as above for each part that you are sending to the Registry. The information for each sample is automatically saved to this shipment number once you click on the "save" link.

Shipment information

[\[edit\]](#)

When you are done filling in the information for all of your samples, click on the "I am finished specifying the samples" button.

Be aware that your shipment has not yet been finalized (even though it has been saved). To do so, you must fill in all of your shipping information. Please provide ALL information.

in all of your shipping information. Please provide ALL information.

Shipping details	
Date Sent:	<input type="text" value="yyyy-mm-dd"/>
Tracking #:	<input type="text" value="None provided"/>
Carrier:	<input type="text" value=""/>
Comments:	<input type="text" value=""/>

If you need to obtain a tracking number for your package before finalizing your shipment, you may do so at anytime and come back to finalize your shipment once you have a tracking number. You must provide the shipping details before your information gets sent to the Registry so make sure to come back and complete the shipping details portion of the form.

When you are finished providing shipping details, click on the "I am finished filling in this information" button to send your information to the Registry.

I am finished filling in the information, Send this batch to the Registry

This finalizes your shipment information. You will see a confirmation page that congratulates you on submitting your information. It will also show all parts that are part of that shipment number. We recommend printing out this page for your records.

At this point you can go back to the DNA Submission Registry page and click on "see your DNA submissions" to check on the status of your shipment. You will be able to see when we have received your shipment and once we have finished testing your parts, you will be able to see the results from our quality control tests.

If for any reason we reject your part we will notify you by email (see below for possible reasons your part might be rejected). The email will be sent to the user who filled out the online submission form. The rest of the parts in your shipment that passed the quality control tests will be marked as Accepted but you will have to resubmit the parts that did not pass successfully. These parts must be resubmitted as a new shipment using the online DNA submission form once again.

Reasons for failing quality control:

- Failed to transform
- Did not grow in culture
- Growth in wrong antibiotic broth in antibiotic test
- Wrong fragment size when cut with double restriction enzymes

Shipping Instructions

[\[edit\]](#)

Please send your samples via a shipping company that will let you track the shipment. It is important to include your shipment tracking number in your submission information details. Physical DNA for parts is due before the Jamboree (see the [iGEM requirements](#)) and if we do not receive your shipment, we will track your package and give that information to the judges. If your shipment does not have tracking information and has not arrived at the Registry we will count your physical DNA as **not available**. You will not be able to receive a medal, as per the [iGEM requirements](#).

Important: When shipping your samples, make sure to include a detailed description of the package so that it gets through customs. Write the following:

Dry/liquid DNA, non-hazardous, non-infectious, non-regulated. For research use only.



USTC
University of Science and Technology of China

[Home](#) [Team](#) [Project](#) [Modeling](#) [Parts](#) [Standard & Protocol](#) [Tool](#) [Human Practice](#) [Notebook](#)

Team:USTC [\[edit\]](#)

Contents [\[hide\]](#)

- 1 Team:USTC
 - 1.1 Welcome to the Wiki of USTC iGEM 2009 Wet Lab Team!
 - 1.1.1 Team USTC
 - 1.1.2 Project E.ADEM
 - 1.2 Links

Welcome to the Wiki of USTC iGEM 2009 Wet Lab Team! [\[edit\]](#)

Team USTC [\[edit\]](#)

Our team is consist of members with different backgrounds, saying biology, mathematics, chemistry, computer science and physics, but with the same enthusiasm and confidence to do some thing both fundamental and original. We really appreciate your visit, and from this wiki you'll find records of our meetings and discussions, as well as keep up with our everyday progress.

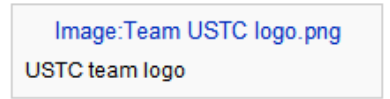

Project E.ADEM [\[edit\]](#)

Evolution is more powerful than the God, as Charles Darwin told us 150 years ago. This year, our team is trying to manage the power of evolution, the power of creating everything from molecules to ecosystems, by engineering an ***E. coli* Automatic Directed Evolution Machine (E.ADEM)**.

Our goal is to make E.ADEM a universal framework for directed evolution of almost anything: from promoters, regulators, receptors,

- Bronze Medal
- Silver Medal
- Gold Medal

The requirements to earn a Bronze Medal are:

1. Register the team, have a great summer, and have fun attending the Jamboree.
2. Successfully complete and submit a Project Summary form.
3. Create and share a Description of the team's project via the iGEM wiki (see [TUDelft 2008](#) for a great example).
4. Present a Poster and Talk at the iGEM Jamboree (watch the [Heidelberg 2008 video](#) for a great example).
5. Enter information detailing at least one new standard BioBrick Part or Device in the Registry of Parts
 - Entered information for each new part or device should at least include primary nucleic acid sequence, description of function, authorship, any relevant safety notes, and an acknowledgement of sources and references. Consider [BBa_J45004](#) as one example (be sure to check Main, Design Page, and Experiences sub-pages for this part).
 - Teams are currently expected to design and contribute standard biological parts that conform to the accepted BioBrick standards for physical assembly. Non-BioBrick parts will not be recognized by iGEM 2009 judges unless they have [specific approval](#). The two specific BioBrick physical assembly schemes that the judges will recognize by default are (i) Tom Knight's [original assembly standard](#) and (ii) Ira Phillips [fusion assembly standard](#).
 - [Special Note. A discussion has been initiated by the BioBricks Standards Working Group to consider updating the BioBrick assembly standard in time for June 1. Check back for any updates on acceptable BioBrick assembly standards.]
 - Any new Devices that are based on gene expression are expected to conform to the PoPS device boundary standard. See chapter 3 of the book, [Adventures in Synthetic Biology](#), for more information about common signal carriers and PoPS.
6. Submit DNA for at least one new BioBrick Part or Device to the Registry of Parts.
 - The submitted DNA must be associated with a Part or Device for which you have entered information describing the part or device, and must conform to the BioBrick standards for Parts or Devices (see above).

The requirements to earn a Silver Medal, in addition to the Bronze Medal requirements, are:

1. Demonstrate that at least one new BioBrick Part or Device of your own design and construction works as expected.
2. Characterize the operation of at least one new BioBrick Part or Device and enter this information on the Parts or Device page via the Registry of Parts (see [BBa_F2620](#) for an exemplar).

The requirements to earn a Gold Medal, in addition to the Silver Medal requirements, are any one OR more of the following:

1. Characterize or improve an existing BioBrick Part or Device and enter this information back on the Registry.
2. Help another iGEM team by, for example, characterizing a part, debugging a construct, or modeling or simulating their system.
3. Develop and document a new technical standard that supports the (i) design of BioBrick Parts or Devices, or (ii) construction of BioBrick Parts or Devices, or (iii) characterization of BioBrick Parts or Devices, or (iv) analysis, modeling, and simulation of BioBrick Parts or Devices, or (v) sharing BioBrick Parts or Devices, either via physical DNA or as information via the internet.
4. Outline and detail a new approach to an issue of Human Practice in synthetic biology as it relates to your project, such as safety, security, ethics, or ownership, sharing, and innovation.

Safety

For iGEM 2009 teams are asked to detail how they approached any issues of biological safety associated with their projects.

Specifically, teams should consider the following four questions:

1. Would any of your project ideas raise safety issues in terms of:
 - researcher safety,
 - public safety, or
 - environmental safety?
2. Is there a local biosafety group, committee, or review board at your institution?
3. What does your local biosafety group think about your project?
4. Do any of the new BioBrick parts that you made this year raise any safety issues?
 - If yes, did you document these issues in the Registry?

Teams, please document any answers to these (or other) safety questions in your presentation, wiki presentation, or poster.

Judges will be asked to evaluate your project, in part, on the basis of if and how you considered and addressed issues of biological safety.

If any questions arise regarding iGEM and biological safety please send an email to [safety AT igem.org](mailto:safety@igem.org).



[Recent changes](#)

[What links here](#)

[Related changes](#)

[Upload file](#)

[Special pages](#)

[My preferences](#)

[Printable version](#)

[Permanent link](#)

[Privacy policy](#)

[Disclaimers](#)



→ **Instructional Video**



Security

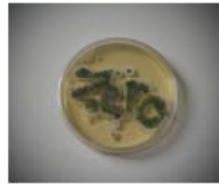

"Biology should be more fun. It should be about exploring the world around us. We should want to get out there and do things. We should be able to do things more easily. Securing biology should be something that helps us do that. It cannot be something that gets in the way."

Scientific research continues to bring us new and unexpected knowledge, technologies and approaches. Synthetic biology, being on the very cutting edge of what is possible, promises unprecedented opportunities for health, wealth and better living. But science and technology can be used for destructive purposes as well as for constructive ones. Refining our control of biology opens up chances to intentionally cause harm to humans, animals, plants and the environment that just did not exist before. That's why it is important now, more than ever, for us to think about how others might use what we are doing in ways we would not be happy with.

Preventing Malign Use

Securing biology is not a simple task. It is not something those outside biology could, or should, do alone. Equally, this is not something that biologists can do by themselves (our focus, as the name implies is on the biology). This is a truly interdisciplinary problem - one that means we will need to work together, in new ways, with new partners, to find an approach that provides benefits for all. Given the interdisciplinary nature of synthetic biology, and the experience the community has in drawing in people from different backgrounds, we are well placed to position ourselves in the vanguard of those thinking about how science interacts with society and to help write the rules which will govern this 'century of biology'.

As a participant in iGEM, there are three things you can do right now to help us secure our science:

1. Include something in your project description and presentations that demonstrates that you have thought about how others could misuse your work
2. Contribute to community discussions on what needs to go into a code against the use of our science for hostile purposes (see A Community Response)
3. Look into what security provisions, such as laws and regulations, are already in place in your country (see Working within the Law)

Resources

People



Piers Millet
BWC ISU
bwc@unog.ch
www.unog.ch/bwc

The BWC ISU is the closest thing to an international organisation to ensure biology is used solely for beneficial purposes. It is housed in the UN Office for Disarmament Affairs in Geneva and, as Deputy Head, Piers helps States Parties to the Biological Weapons Convention ban the hostile use of biology. As a microbiologist and chartered biologist, Piers supports the technical aspects of the ISU's work.

Reports



Synthetic Genomics: Options for Governance
by the J Craig Venter Institute, CSIS and MIT,
October 2007



Synthetic Biology and Biosecurity Awareness in Europe by SynBioSafe,
November 2007

Shaping the Future

Ensuring that biology is used safely, securely and constructively should be of concern to us all. This is a challenge we will have to face together. To do this we will need to figure out what we want biological engineering to look like, what we are prepared for others to do with it, and just how we want to tackle security issues. This page provides a space to focus on these issues and for you to help shape what should be done to stop those with a malign intent. There is a real opportunity here for iGEM and those participating in iGEM, not only to shape how they will deal with security issues but to drive their national and even international processes. You can make a real difference in securing biology – in your lab, in your country and across the world.

A Commitment to Do No harm

There is a strong feeling amongst those involved with iGEM, as well as the broader synthetic biology community, that the work we do should be used only for the benefit of humankind. It should not be used to do harm or to make weapons. This understanding has prompted some to think about what the community can do to ensure that this never happens. One important step would be a code or personal declaration that everyone involved (from the organisers, through supervisors and advisors, to team members and even the mascots!) would commit themselves to. This helps to ensure that we think about security as something that does directly involve us, is part of our project and can be dealt with in a way that helps us to get on and have some fun engineering biology.

A Community Response

Areas a code might address:

- An **introduction** about why there is a code
- A reminder of the importance of **personal responsibility** and that as your career progresses so do your responsibilities
- A commitment to **get informed** about principles and practices designed to prevent hostile use
- A commitment to find out about and **comply with regulatory frameworks**, such as international, national and institutional laws and guidelines
- An obligation to **do no harm**
- A requirement to look at the **reasonably foreseeable consequences** of your activities
- A commitment **not to ignore possible breaches** of the code by others
- An obligation to **act responsibly** in case you stumble across something that does not easily sit with the aims of the code
- Some link between the pursuit of **science and the best**

Any code that would commit community members to do no harm would be first and foremost the property of this community. There is a solid body of work dedicated to the sorts of things that might be included in such an effort (see the Resources section). But nothing should be taken for granted – the content of our code would be up to us to decide. Here are some of the areas that a code might cover. Are these accurate? Can you think of anything else that should be on this list? Is there too much and we should get rid of some (if so, what)? Is there any point to working on a code? Here is where you can get involved – we are hoping that you will have something to say. You can answer these questions or add anything else you want to say (you know the drill) in the comments section below.



and Ethical Challenges by the Institute for Science and Society, May 2008



Trends in American and European Coverage of Synthetic Biology by the Woodrow Wilson International Center for Scholars, 1 November 2008



Technical solutions for biosecurity in synthetic biology by the Industry Association Synthetic Biology, 2008



Synthetic Biology: Scope Applications and Implications by the UK Royal Academy of Engineering, May 2009

Other Resources

Why Secure Modern Biology?

This is a 30 minute video arguing why we need to

secure synthetic biology. It was filmed at SB4.0 in Hong Kong in 2008. It includes a short quiz that demonstrates how hard it is to spot the use of biology for hostile purposes. It looks at some of the problems with trying to secure biology through top-down governmental approaches and the need to find a community-based response to this shared problem.

Working Within the Law

There is an international treaty that prohibits the use of biology for hostile or malign purposes. If you use biology to do harm you will be breaking international law.

Many countries also have their own laws about using biology in this way. They are increasingly backed up with regulations and guidelines that are relevant to the day to day functioning of a laboratory. It is important that we are all familiar with the rules that cover our work. Whilst we are commonly taught how we should work safely, we are less often taught how to work securely.

This section provides a gateway to details of some of these national regulatory frameworks. We hoping that you will use this to make sure you know all you need to know about staying out of trouble. But we are hoping that you will also be able to help us improve this resource. We have provided some information on some of the measures in some of the countries with the largest participation in iGEM. We know this is not a list of all relevant measures in all countries that participate. Here is where you come in. Is there something missing you know applies in your country? If so why not add some information? If you don't know what is in place, why not find out and let us know? That would really help future teams, your professional conduct and the community as a whole.

China

- [Laws in China relevant to work with biological agents](#)

Switzerland

- [Laws in Switzerland relevant to work with biological agents](#)
- [Swiss arrangements for biosafety and biosecurity](#)
- [Swiss arrangements for the oversight of science](#)

United Kingdom

- [Laws in the UK relevant to work with biological agents](#)
- [UK arrangements for biosafety and biosecurity](#)

United States

- [Laws in the US relevant to work with biological agents](#)
- [US arrangements for biosafety and biosecurity](#)
- [US arrangements for the oversight of science](#)

Got Questions?

If there is anything here that has caught your interest, infuriated you and sparked any other reason you would like to get in touch, then please do. You can leave



Part:BBa_F2620:Transfer Function



DNA Available
★ 1 Registry Star

Designed by Barry Canton [bcanton@mit.edu] and Anna Labno [labnoa@mit.edu] Group: Haseloff Lab, MIT (2004-08-09)

[Get This Part](#)

Input: 3OC₆HSL

Output: PoPS

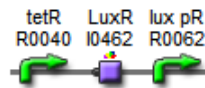

[Part Main Page](#)

[Transfer Function](#)

[Specificity](#)

[Response time](#)

[Stability](#)

[Add Data](#)

The **transfer function** describes the equilibrium relationship between input (exogenous 3OC₆HSL concentration) and output (PoPS) signals. We used the fluorescent reporter device, [BBa_E0240](#) to indirectly measure the output from [BBa_F2620](#) following induction with different exogenous concentrations of 3OC₆HSL. Please see the [part experience page](#) for a general description of our characterization method.

Data

[\[edit\]](#)

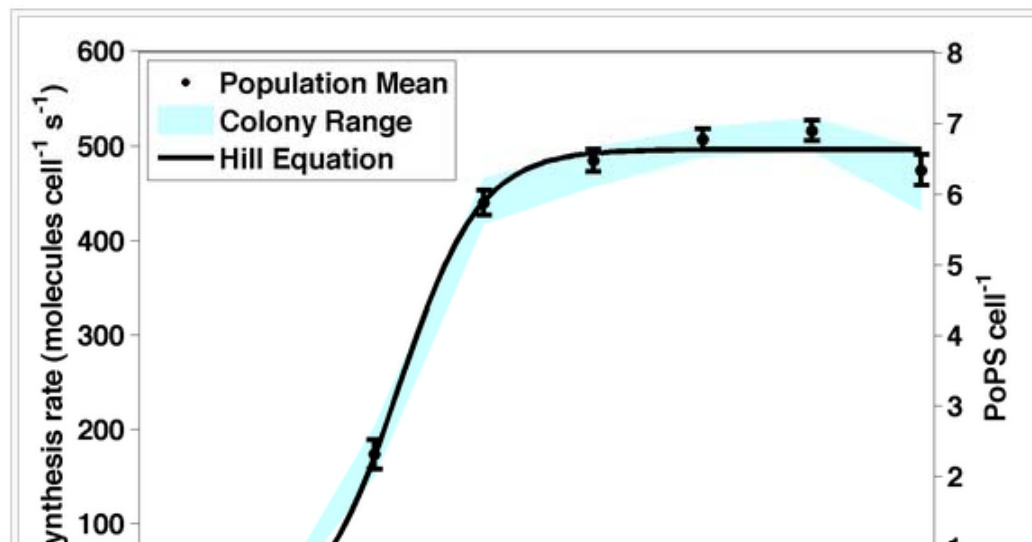

Jamboree

Recently updated:

[General schedule](#)

The iGEM 2009 Jamboree will take place on **October 30th to November 2nd, 2009** at **MIT Stata and Lobby 13** in Cambridge, MA.

Pre-Jamboree

- Register for the Jamboree : **September 18th**
- Submit your project abstract : **September 18th**
- Submit your team roster : **September 18th**
- Requests for variance : **September 18th**
- Select your track : **September 18th**
- Request your visa letter : **June 1st**
- Document your project : **October 21st**
- Document your parts : **October 21st**
- Promote your favorite parts : **October 21st**
- Send in your parts : **October 21st**
- Make your poster
- Prepare your presentation
- Software Tools Track Teams
- Experimental Track Teams
- Print, sign, and bring your photo release form
- Book your hotel
- Guests, family, and friends
- Volunteer for the Jamboree!

During the Jamboree

- Practice your presentation
- Attend sessions
- Impress the judges
- Win some awards
- Wear your team t-shirt
- iGEM Gear

Post-Jamboree

- Check out the results
- Share your pictures
- Share your press
- iGEM 2009: press kit
- Get ready for iGEM 2010!

Documentation

[\[edit\]](#)

Project: According to the [iGEM requirements](#), each iGEM team's project should be documented on the iGEM 2009 wiki site with detail enough to replicate it independently. Additional presentational information about the team - their story, the rationale for the project, failures, successes, future work, etc. - is highly encouraged. Remember that these wiki pages will be the main source of inspiration for future teams, and having good documentation on them and in the part description in the registry increases the likelihood of more teams building on your project and your parts. What is considered proper documentation is decided by the judging committee and you can find details about proper documentation at the [Judging](#) page.

Parts: iGEM [requirements](#) also state that all teams must properly document their parts on the [Registry](#). The judging committee also decides what is considered proper part documentation. See the [Judging](#) page for details. Remember, the success of not just iGEM, but all of synthetic biology, depends on the development of well-characterized, reliable, standardized biological parts that have been designed to be simple to use and understand.

DNA Submissions

[\[edit\]](#)

iGEM teams are expected to submit their parts to the [Registry of Standard Biological Parts](#). In addition to submitting your parts, you must also declare which of your parts are your "favorites." Judges will only be looking at favorite parts so make sure to promote them before the October 21st deadline.

See the [DNA submission requirements](#) for more information about the DNA submission process.

Poster Requirements

[\[edit\]](#)

There will be two poster sessions at the iGEM 2009 Jamboree. Each team will be assigned to ONE of the two poster sessions. Locations will be assigned prior to your arrival at the Jamboree. You will be required to put up your poster by 9am on the day of your session. Posters shall be NO LARGER than 48 inches by 48 inches (1.22m x 1.22m).

For details on poster judging see the [judging page](#). Keep in mind that the poster must be able to convey your team's project fully. It should be able to be judged without any external information or input from team members.

iGEM HQ will be asking for a copy of your poster in pdf format for our files. You will be required to provide the pdf version of your poster at the time of your presentation.

Presentation Requirements

[\[edit\]](#)

Each registered iGEM team is to make a 20-minute presentation, followed by 5 minutes of questions/answer session. A laptop will NOT be provided to your team -- please make sure you bring your own laptop from which to display your presentation as well as any necessary accessories to connect the laptop to a projector cable.

iGEM HQ will also be asking for a copy of your presentation in pdf format for our files. You will be required to provide the pdf version of your presentation on Saturday, the day of Jamboree presentations. Please check back for more details on how to submit your presentation.

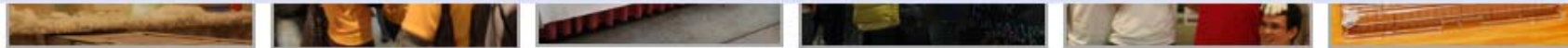

Show off your team spirit!



The Jamboree is less than a month away, and although you must be busy with preparations, you should also think about your team t-shirts. You're representing your team and university, so why not [show off!](#)

Design and wear your team t-shirt, especially for the [iGEM from Above photograph](#). And since this year's Jamboree falls on Halloween (October 31) weekend, it'll be fun to have a team costume or mascot.

October 9, 2009

Volunteering for the Jamboree

We're currently looking for volunteers who would like to help out during the iGEM 2009 Jamboree (October 30th to November 2nd). If you're an iGEM alum, interested in synthetic biology, or would like to take a peek at what we're doing at iGEM and the Registry of standard parts, we'd love to have your help. Check out the [volunteer page](#) to see how you can help.

September 30, 2009

Jamboree social event



We need help planning iGEM 2009 Jamboree social event! Check out the [social event planning page](#) to see how you can help.

September 29, 2009

Early registration closed

About iGEM

- [What is iGEM?](#)
- [Previous iGEM competitions](#)
- [iGEM Headquarters](#)
- [Frequently Asked Questions](#)
- [iGEM Press Kit](#)
- [Join the iGEM Mailing List](#)
- [Sponsor iGEM](#)

iGEM Start to Finish

- [Calendar of events](#)
- [Start a team](#)
- [Requirements](#)
- [iGEM 2009 Registration](#)
- [Spring workshops](#)
- **Summer News & Events**
- [The Jamboree](#)
 - [Registration](#)
 - [Schedule](#)
 - [Judging](#)
- [iGEM Publicity](#)
- [iGEM Publications](#)
- [Safety](#)
- [Security](#)

Resources

- [2009 teams](#)
- [2009 team wikis](#)
- [2009 team parts](#)
- [iGEM Partner Offers](#)
- [Instructional Videos](#)
- [Using the wiki](#)
- [Registry of Standard Parts](#)
- [Main page archive](#)

[twitter](#) [facebook](#)

[Forum](#)

Jamboree/Team Spirit

Team Spirit

[edit]

The Jamboree is coming up, and although you must be busy with preparations, you should also think about your team spirit! At the Jamboree you will be representing your team and university, so why not show off!

Team T-shirts

[edit]

Designing team t-shirts is always a good idea, and here at iGEM HQ we encourage you to wear them. They make for a particularly nice [iGEM from Above photograph](#) as well. Wear your school colors, your team's name, something completely random, or give a shout-out to your team's sponsors.

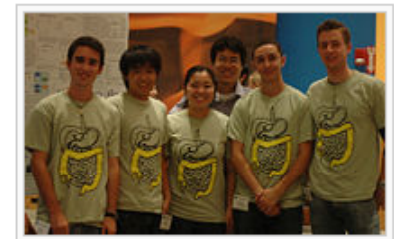

iGEM 2008 Team T-shirts

Team Mascots

[edit]

While we all love t-shirts, we're also up for trying out something new. The iGEM 2009 Jamboree falls on Halloween (October 31) weekend, so why not have a team costume/mascot. Give your "Home-Base" and the Jamboree some local character, and compete for best mascot at the [iGEM social event](#). Get colorful and creative.

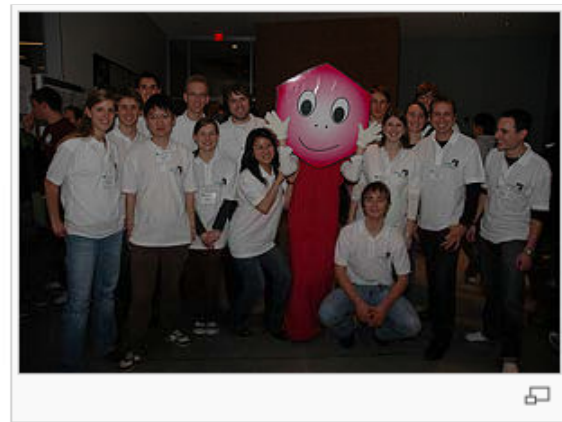

Jamboree/Schedule

Notes:

- Team presentation assignments will be posted at a later date.
- Sign up for a [practice presentation slot](#).



iGEM 2009 Jamboree

Friday (October 30)

	Pre-Registration
6:00 PM - 10:00 PM	Practice Presentations

Saturday (October 31)

8:00 AM	Registration / Breakfast
8:30 AM	Opening Ceremony
9:00 AM	Travel to rooms
9:30 AM	Session 1
10:00 AM	
10:30 AM	BREAK
11:00 AM	Session 2
11:30 AM	
12:00 PM	Session 2
12:30 PM	LUNCH
1:00 PM	Session 3
2:30 PM	
3:00 PM	Session 3
3:30 PM	BREAK
4:00 PM	Session 4
4:30 PM	
5:00 PM	Poster session A
7:00 PM	End

Sunday (November 1)

7:30 AM	Breakfast
8:00 AM	Travel to rooms
8:30 AM	Session 1
9:00 AM	
9:30 AM	BREAK
10:00 AM	Session 2
10:30 AM	
11:00 AM	Session 2
11:30 AM	LUNCH
1:30 PM	Session 3
2:00 PM	
2:30 PM	Session 3
3:00 PM	BREAK
3:30 PM	Session 4
4:00 PM	
4:30 PM	Poster session B
5:00 PM	Free/Travel time
7:00 PM	Social event @ Jillian's Boston
8:00 PM	
12:00 AM	End

Monday (November 2)

8:00 AM	Breakfast
8:30 AM	Opening remarks
8:45 AM	Finalist 1
9:10 AM	Finalist 2
9:35 AM	Finalist 3
10:00 AM	BREAK
10:30 AM	Finalist 4
10:55 AM	Finalist 5
11:20 AM	Finalist 6
11:45 AM	Remarks
12:15 PM	iGEM from Above/Judging
12:45 PM	Awards, Grand Prize Announcement
1:45 PM	End (* approximate)

* Note the schedule is subject to change. Finalized copy will be provided in your registration folders.

Jamboree/Schedule/Practice sessions

Friday October 30 : Practice Talks sign-up sheet

[\[edit\]](#)

Use this sign-up sheet to sign up for a slot on Friday night (October 30) to practice your talk. Note that there will NOT be any A/V (audio/visual) support on staff. All classrooms will be unlocked and you should use them and leave them as you found them.

There are a limited number of time slots available on a first-come first-serve basis so please only choose one slot. We cannot match the room that you will ultimately give your presentation in with the practice room. This should, however, give you a chance to practice your talk in a new environment.

Also, there will also be pre-registration available beginning at 6pm. Conference services will be on-site to pass out team registration boxes (see the [Jamboree](#) page).

(Pizza and refreshments will be available on a first-come first-serve basis)

Time	room 32-123	room 32-141	room 32-155	room 32-G449	room 32-D463	room 32-261*	room 32-262*	room 32-346*	room 32-397*
6:00p - 6:30p	Stanford	PKU_Beijing	C1	D1	E1	F1	G1	H1	I1
6:30p - 7:00p	Warsaw	Southampton	C2	D2	E2	F2	G2	H2	I2
7:00p - 7:30p	IIT_Madras	Heidelberg	C3	D3	E3	F3	G3	H3	I3
7:30p - 8:00p	Tokyo_Tech	B4	C4	D4	E4	F4	G4	H4	I4
8:00p - 8:30p	KULeuven	B5	C5	D5	E5	F5	G5	H5	I5
8:30p - 9:00p	USTC	B6	C6	D6	E6	F6	G6	H6	I6
9:00p - 9:30p	USTC_Software	B7	C7	D7	E7	F7	G7	H7	I7
9:30p - 10:00p	A8	B8	C8	D8	E8	F8	G8	H8	I8

Important information for rooms marked with an asterisk (*):

- Your team will be contacted to coordinate having an iGEM staff member escort you to these rooms as they are in a limited-access part of the Stata Center.
- These rooms are smaller conference rooms throughout the Stata Center.
- Saturday sessions will not be held in these rooms but in order to accommodate all teams who would like to practice their presentations in the 4-hour period on Friday night, we must open these rooms for practice sessions.

Jamboree/Social Event



Contents [\[hide\]](#)

- 1 Event Details
 - 1.1 Transportation
 - 1.2 Team Mascots
- 2 Event Planning
 - 2.1 Program
 - 2.2 Music
 - 2.3 Video
 - 2.4 Decollation
 - 2.5 The Members of the Committee

Why don't you join us?

Event Details

[\[edit\]](#)

The party will take place at [Jillian's of Boston](#) on Sunday, November 1 from 8pm to 12am. There will be dancing, billiards, bowling, lounge space, and cash bar (21+ with valid ID) on the 1st and 2nd floors of Jillian's.

Transportation

[\[edit\]](#)

We have arranged to have shuttle buses to bring people from MIT campus to the event location at Jillian's in the Fenway area of Boston. Detailed information will be provided in your registration packet handbook and on the [Jamboree page](#).

Team Mascots

[\[edit\]](#)



Help us bring some iGEM fun to the party... bring your [team mascots](#) to the social event!

Event Planning

[\[edit\]](#)

We want your help in planning the iGEM 2009 Jamboree Social Event!!!

We named the social event "iCEM dance party" (International Cultural Exchange Masquerade dance party), but the event plan is not determined. Then we decided to set up the committee and to plan the party all together. If you are interested in helping, please enter each discussions and add your name on "The Members of the Committee" section.

Program

[\[edit\]](#)

Assembly

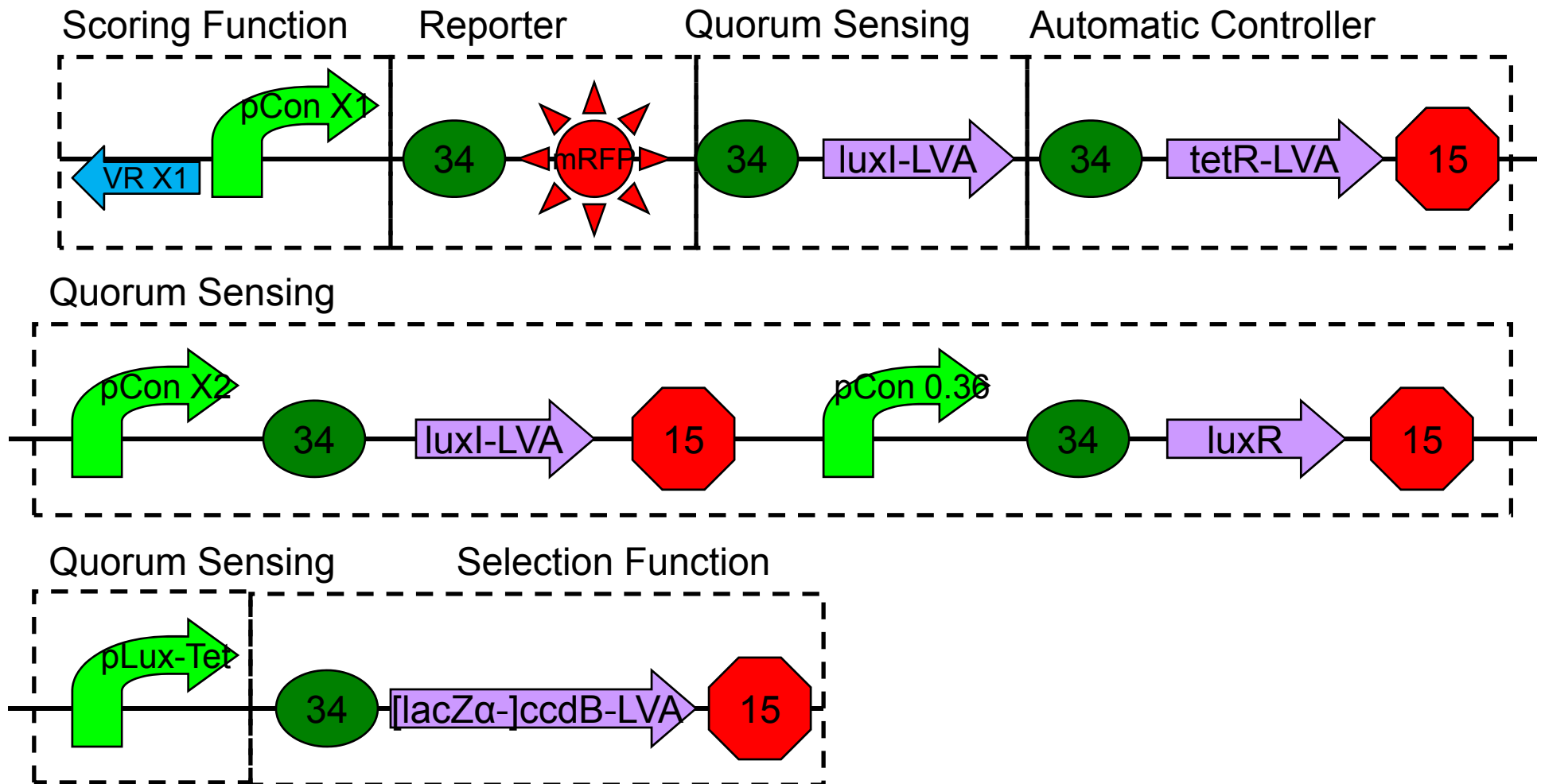

1. pLux-Tet
2. pLux-Tet + GFP
3. pCon \times 4 + luxR + pLux-Tet
4. ccdB \times 8
5. pCon \times 8
6. pCon \times 8 + GFP
7. pCon + luxR
8. pCon \times 7 + luxI (AHL detection by 9)
9. pCon + luxR \times 4 + pLux-Tet + GFP (AHL)
10. pCon + luxR \times 4 + pLux-Tet + ccdB \times 8 (AHL)
11. tetR \times 2
12. tetR \times 2 + pCon \times 2 + luxR + pLux-Tet [+ GFP]
13. pCon \times 4 + tetR \times 2 + pCon \times 2 + luxR + pLux-Tet [+ GFP] (AHL/aTc)
14. [pCon \times 7 +] luxI + pCon \times 2 + luxR + pLux-Tet [+ ccdB \times 8 | + GFP]
15. VR \times 10
16. (VR + pCon) \times 7
17. tetR + pCon + luxI + pCon + luxR + pLux-Tet [+ ccdB]
18. [mRFP +] luxI + tetR + pCon + luxI + pCon + luxR + pLux-Tet [+ ccdB]
19. (VR + pCon) \times 6 + tetR + pCon + luxI + pCon + luxR + pLux-Tet [+ ccdB]
20. (VR + pCon) \times 6 + mRFP + luxI + tetR + pCon + luxI + pCon + luxR + pLux-Tet [+ ccdB]

Delayed
Waiting
Working
Done
Sequenced

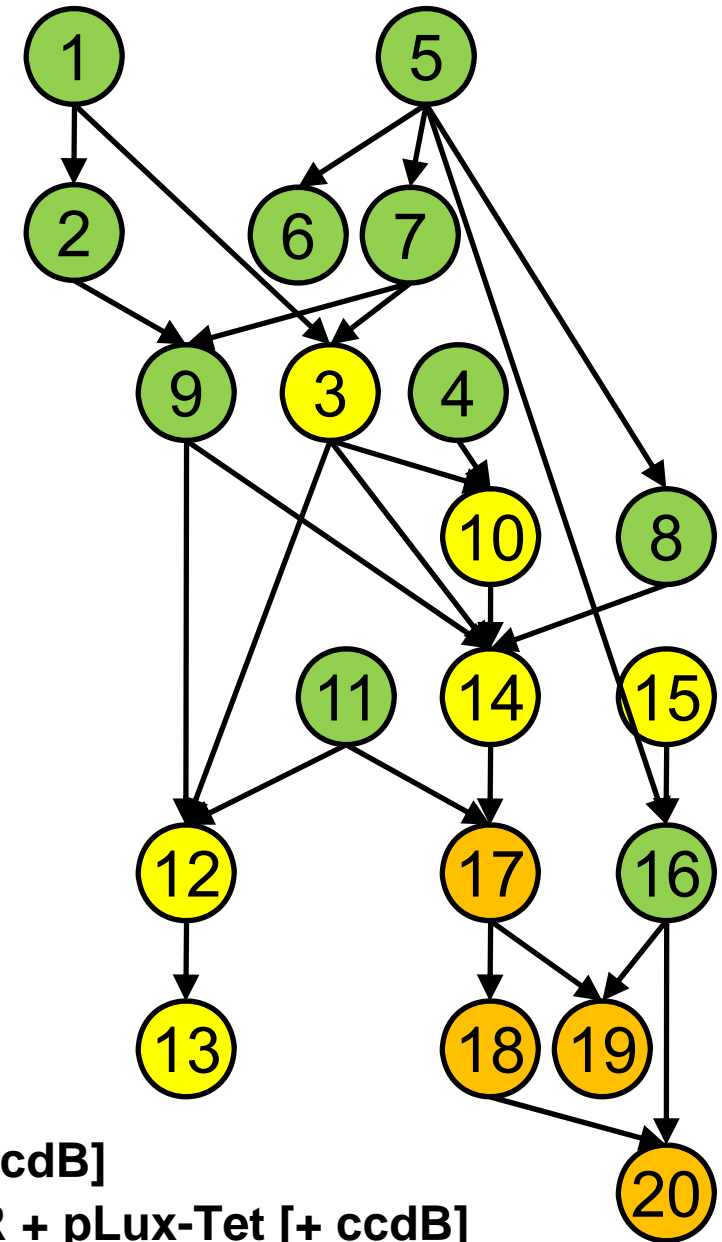

Evolution Object

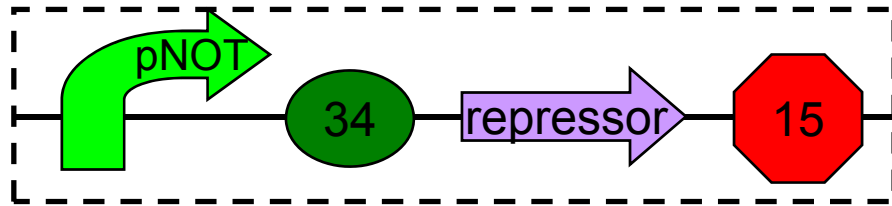

Scoring Function

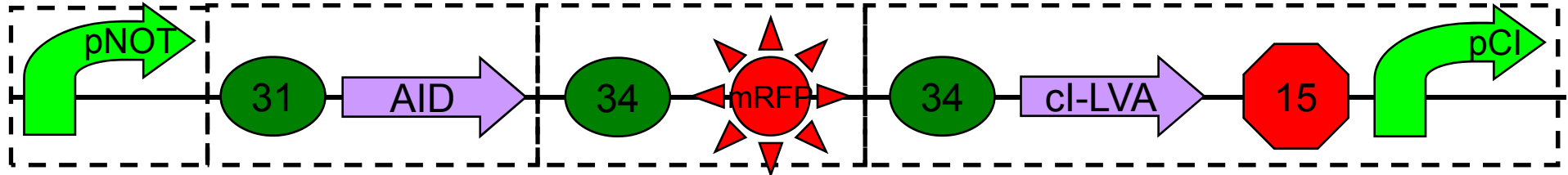

Quorum Sensing

Automatic Controller

Quorum Sensing

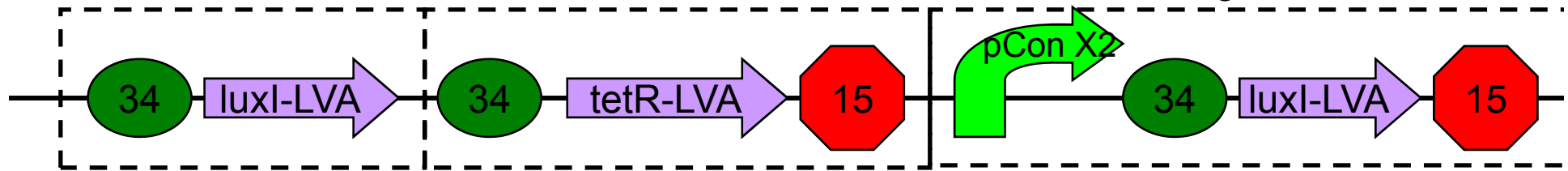

Quorum Sensing

Selection Function

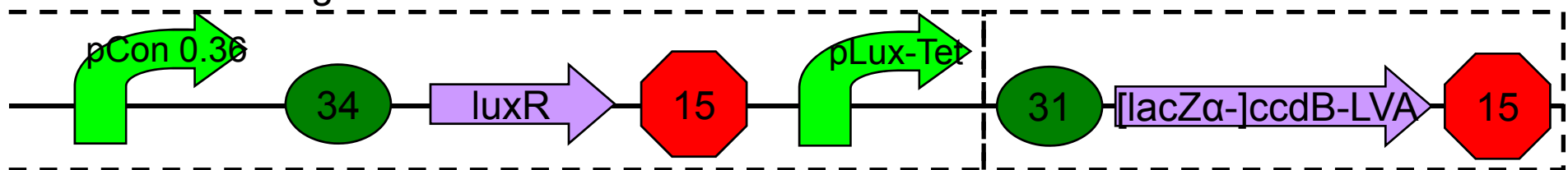

- 21. cl + pCl
- 22. cl + pCl + GFP
- 23. (VR + pCon) × 7 + cl + pCl + GFP
- 24. cl + pCl + luxI
- 25. AID
- 26. [AID +] mRFP + cl + pCl + luxI
- 27. [AID +] mRFP + cl + pCl + luxI + tetR + pCon + luxI + pCon + luxR + pLux-Tet [+ ccdB]
- 28. (VR + pCon) × 7 + mRFP + cl + pCl + luxI + tetR + pCon + luxI + pCon + luxR + pLux-Tet [+ ccdB]
- 29. pNOT
- 30. pNOT + GFP
- 31. pNOT + [AID +] mRFP + cl + pCl + luxI
- 32. pNOT + [AID +] mRFP + cl + pCl + luxI + tetR + pCon + luxI + pCon + luxR + pLux-Tet [+ ccdB]
- 33. repressor
- 34. pNOT + repressor

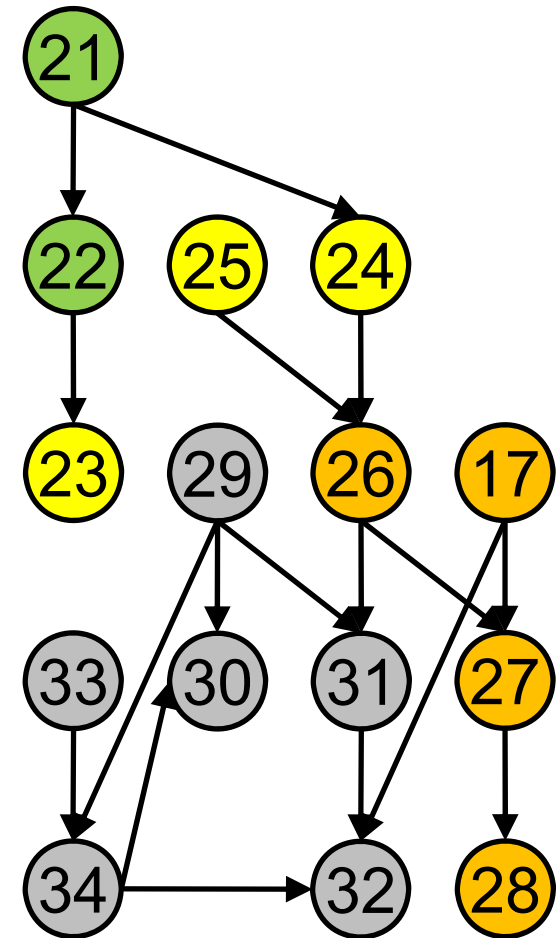

1

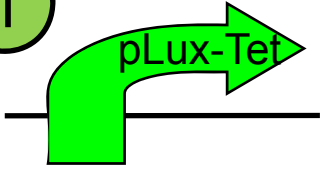

K176000 X+P with nicks
Sequence OK



G00100
Synthesis OK



G00101
Synthesis OK

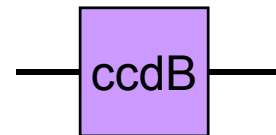

P1010 in pSB1A3 in DB 3.1
Length OK



pSB1A3 X+P
Length OK

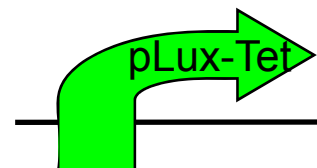

K176000 in pSB1A3
Sequence OK

2

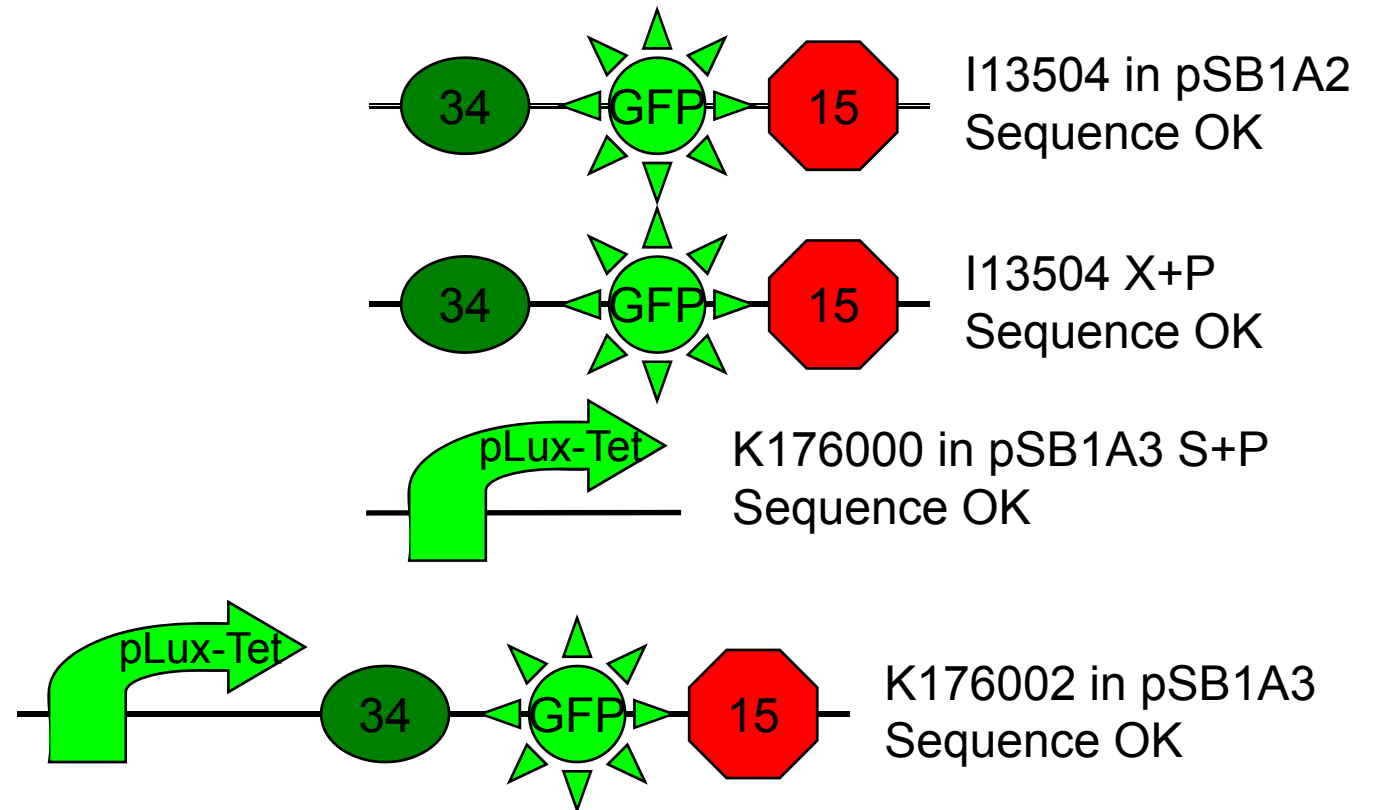

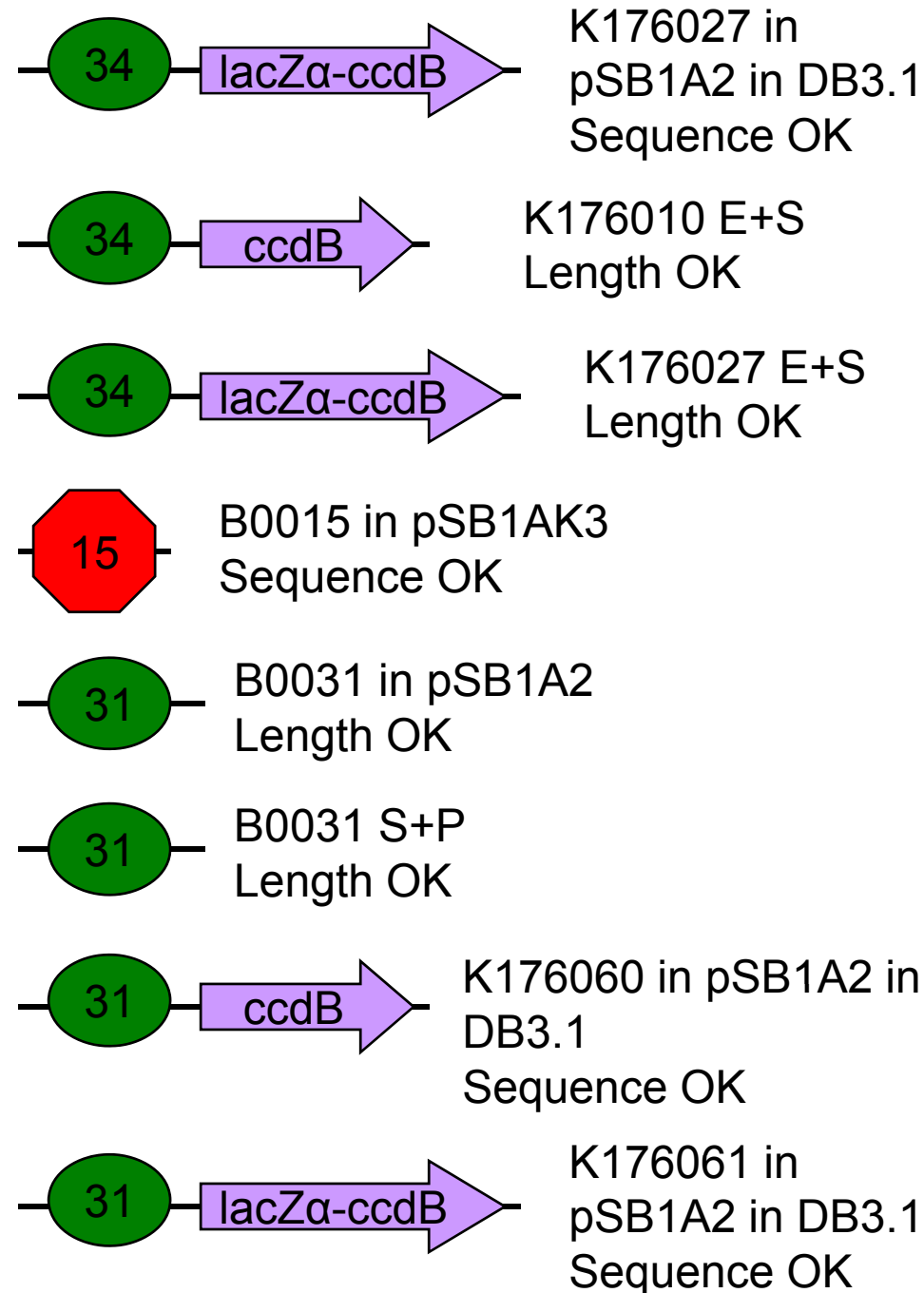
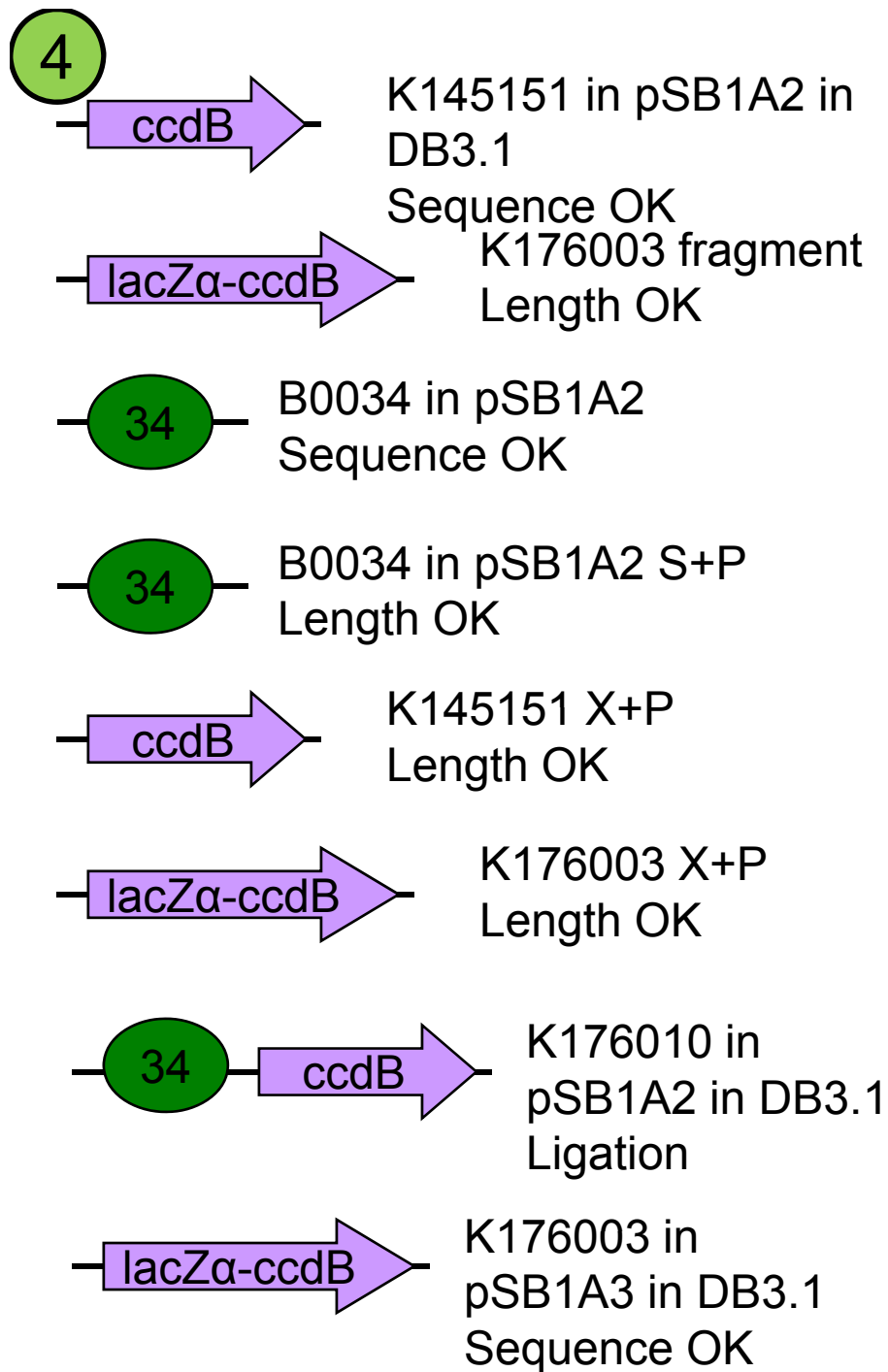

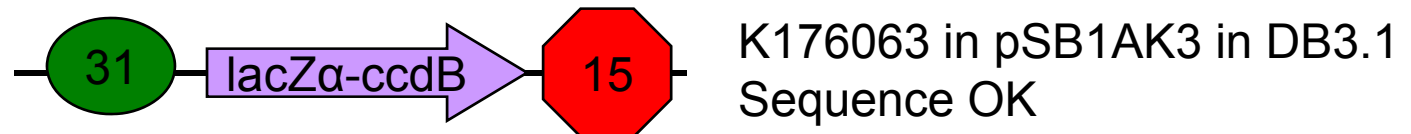
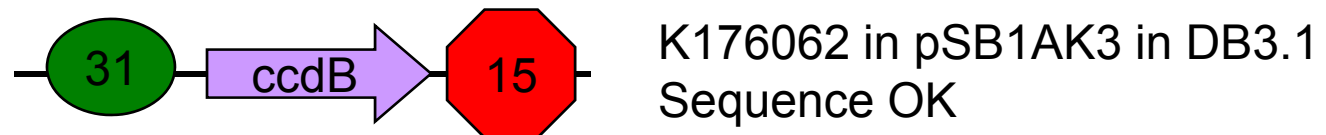
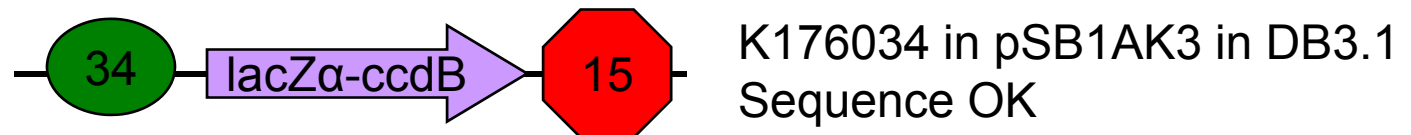
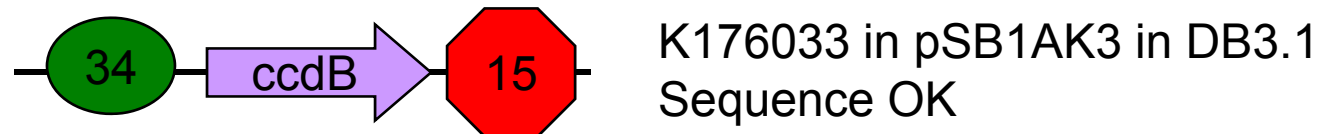
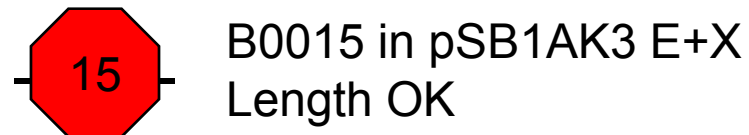
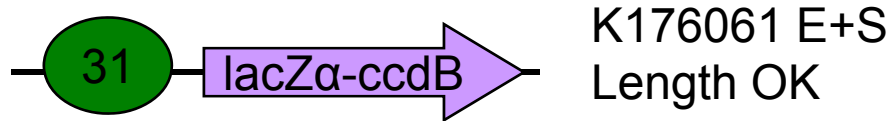
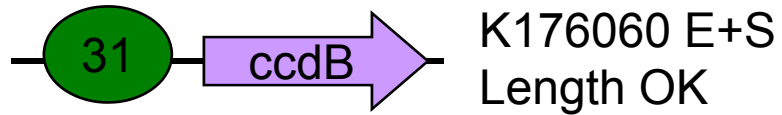

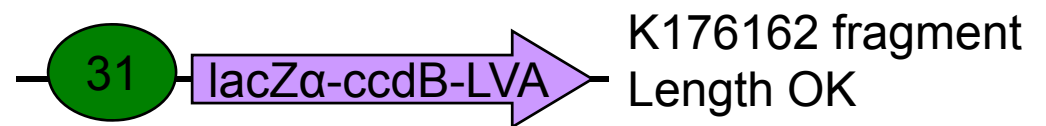
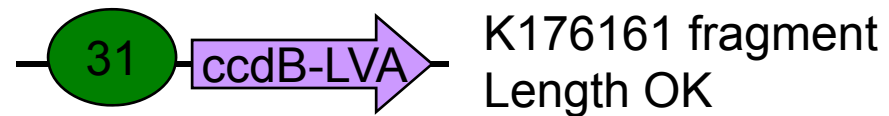
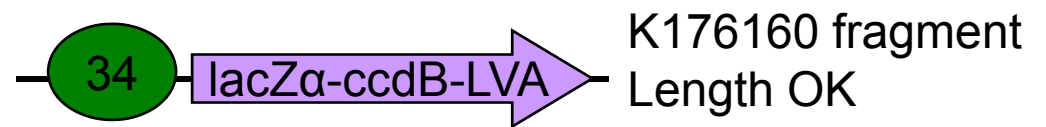
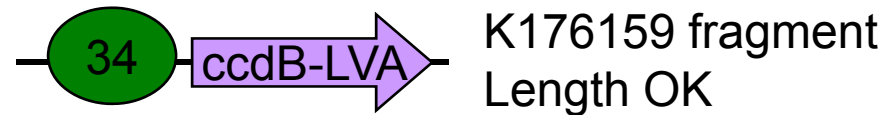
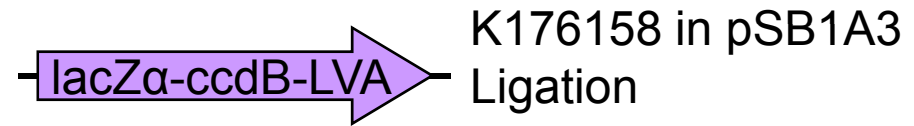
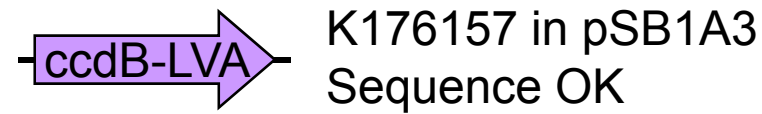
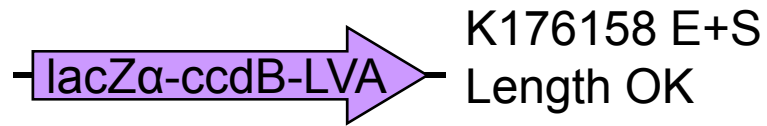
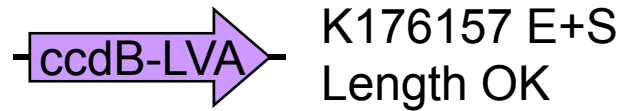
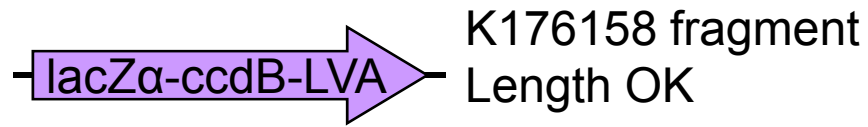

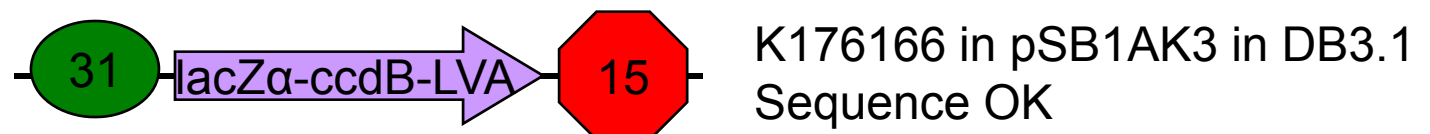
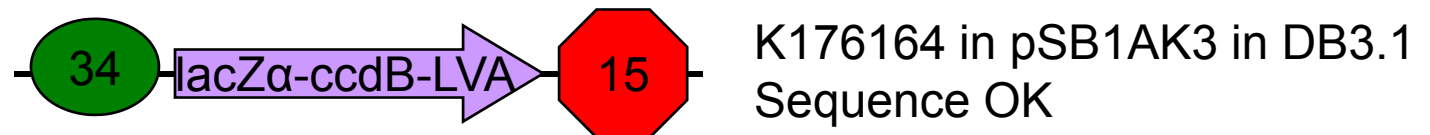
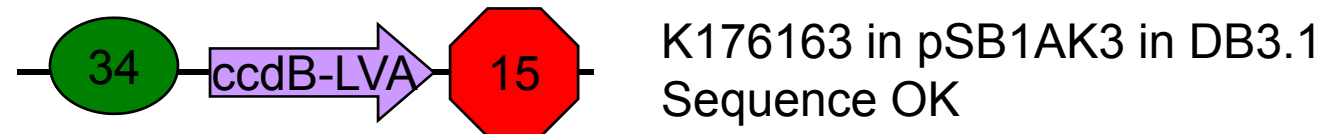
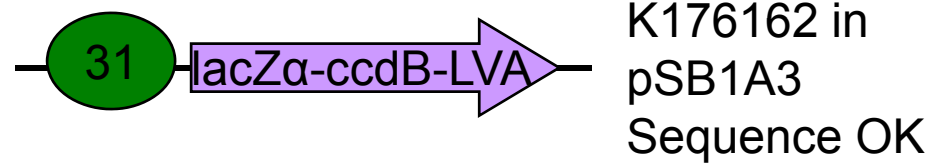
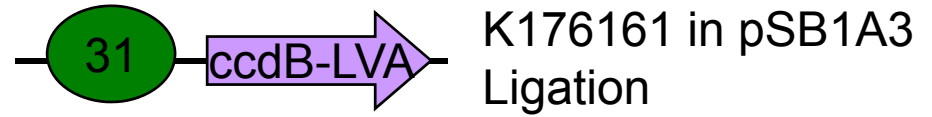
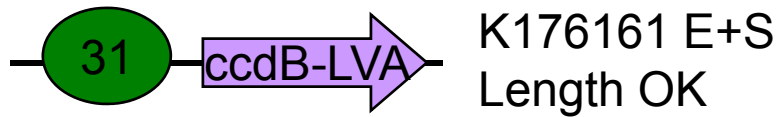
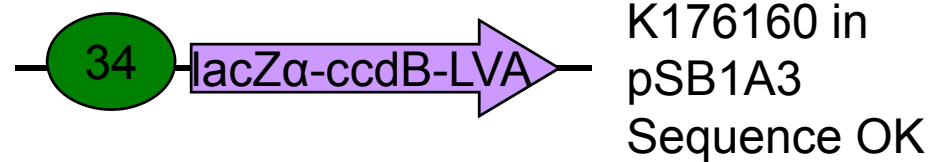
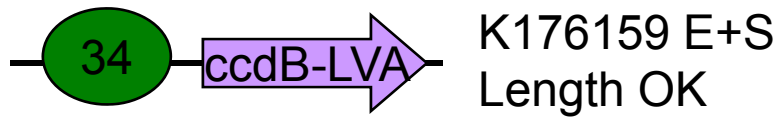

5

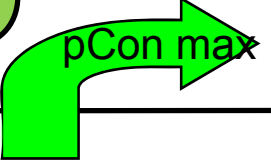

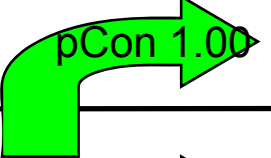
pCon max J23119 in pSB1A2
Sequence OK

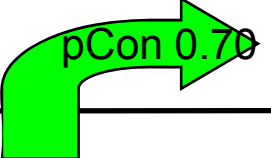

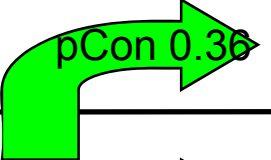
pCon 1.00 J23100 in J61002
Sequence ?

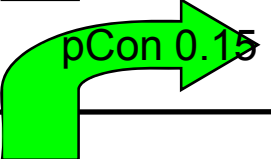

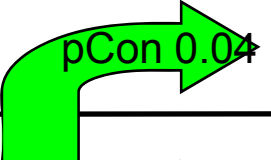
pCon 0.70 J23101 in J61002
Sequence OK

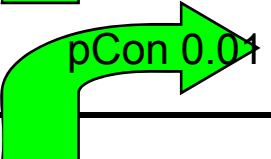

pCon 0.36 K176009 in J61002
Sequence OK

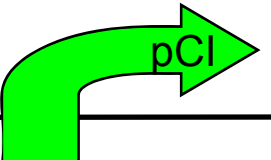

pCon 0.15 K176008 in J61002
Sequence OK

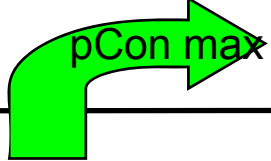

pCon 0.04 J23109 in J61002
Sequence OK



pCon 0.04 J23103 in J61002
Sequence OK

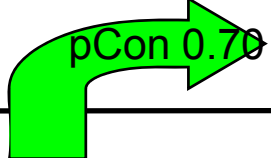

pCl R0051 in pSB1A2
Sequence OK

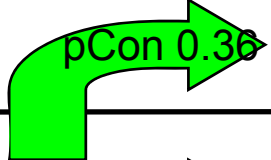

pCon max J23119 X+P
Sequence OK

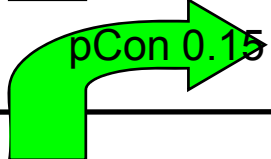

pCon 1.00 J23100-J61002SF X+P
Sequence ?

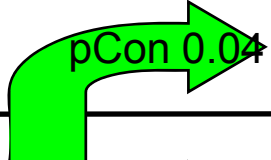

pCon 0.70 J23101-J61002SF X+P
Sequence OK

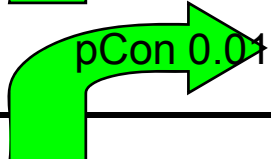

pCon 0.36 K176009-J61002SF X+P
Sequence OK

pCon 0.15 K176008-J61002SF X+P
Sequence OK

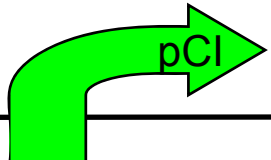

pCon 0.04 J23109-J61002SF X+P
Sequence OK

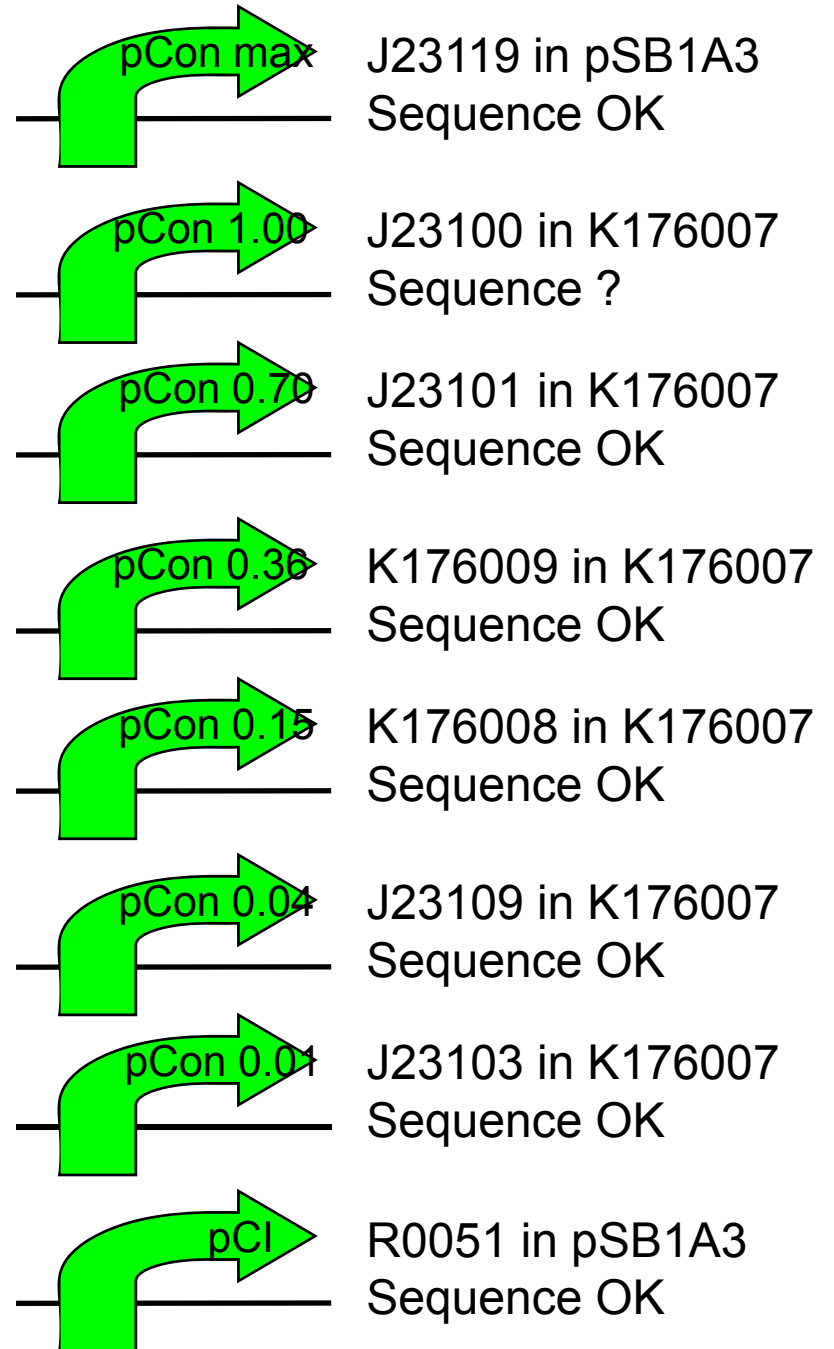

pCon 0.04 J23103-J61002SF X+P
Sequence OK

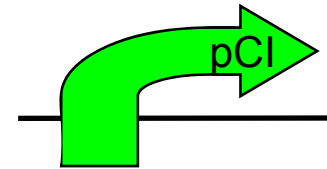
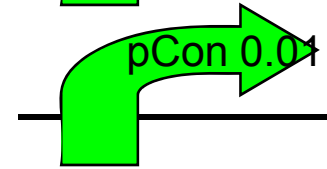
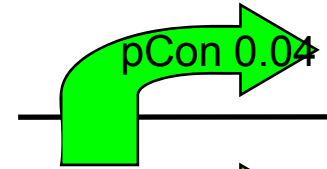
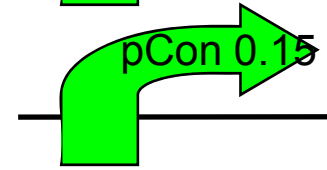
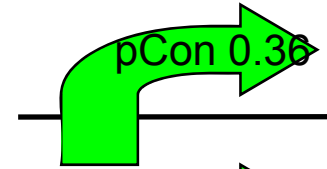
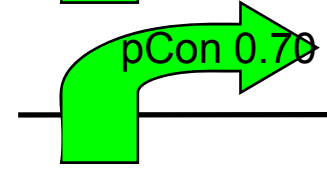
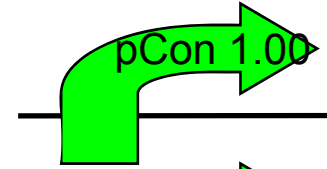
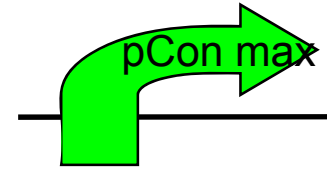
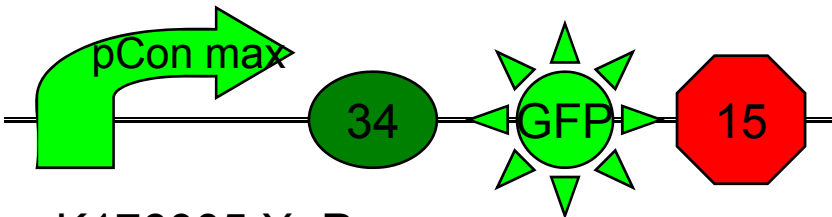
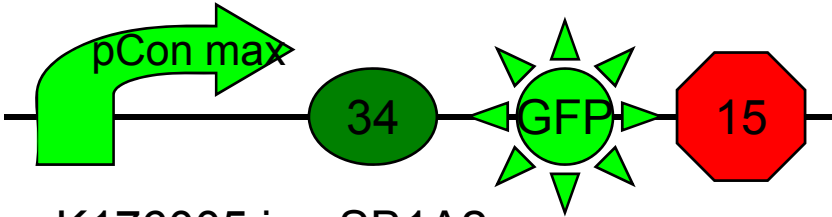
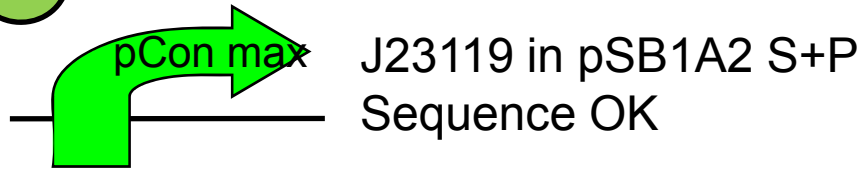

pCl R0051 X+P
Length OK

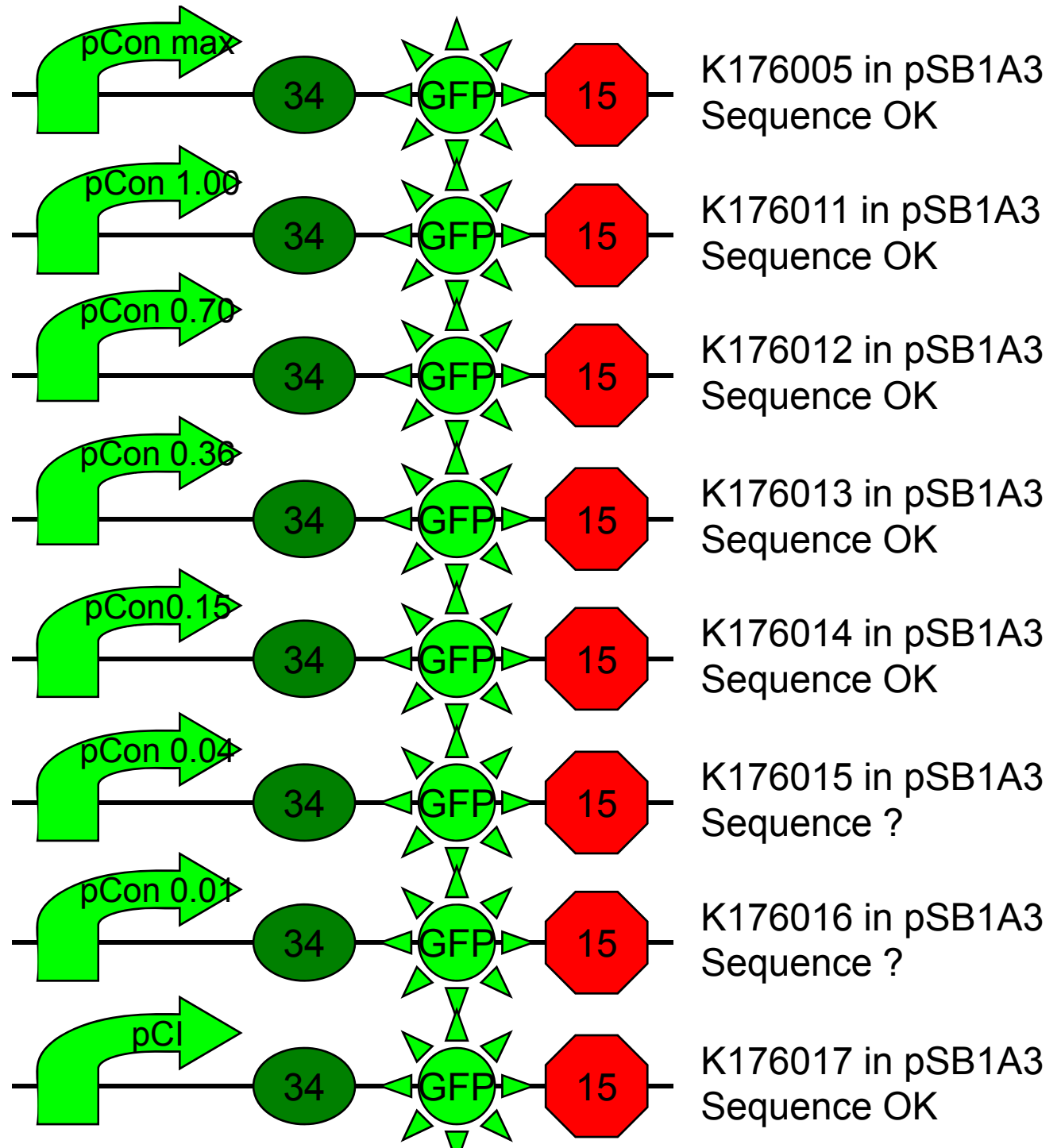

6



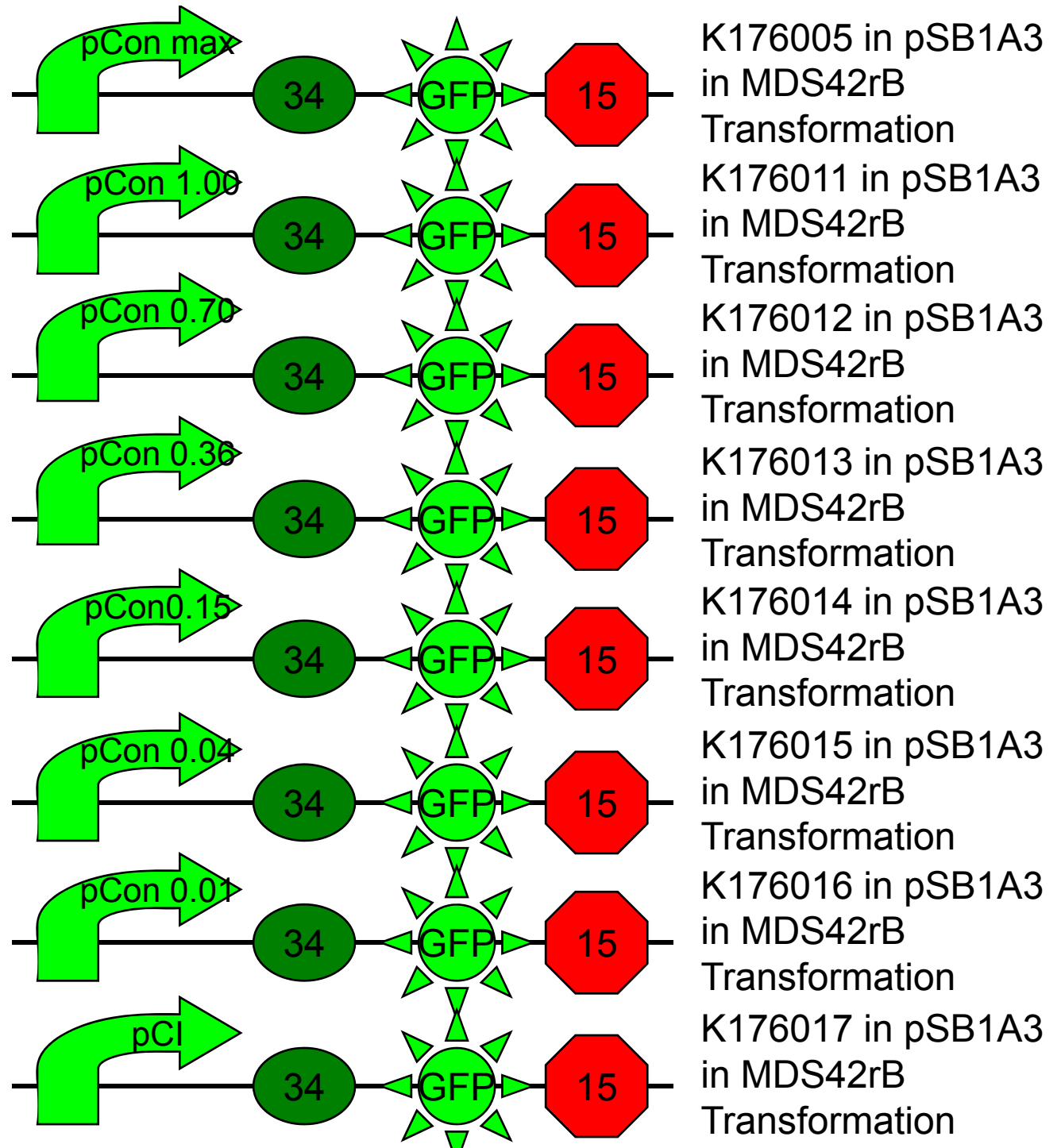



Flu:OD

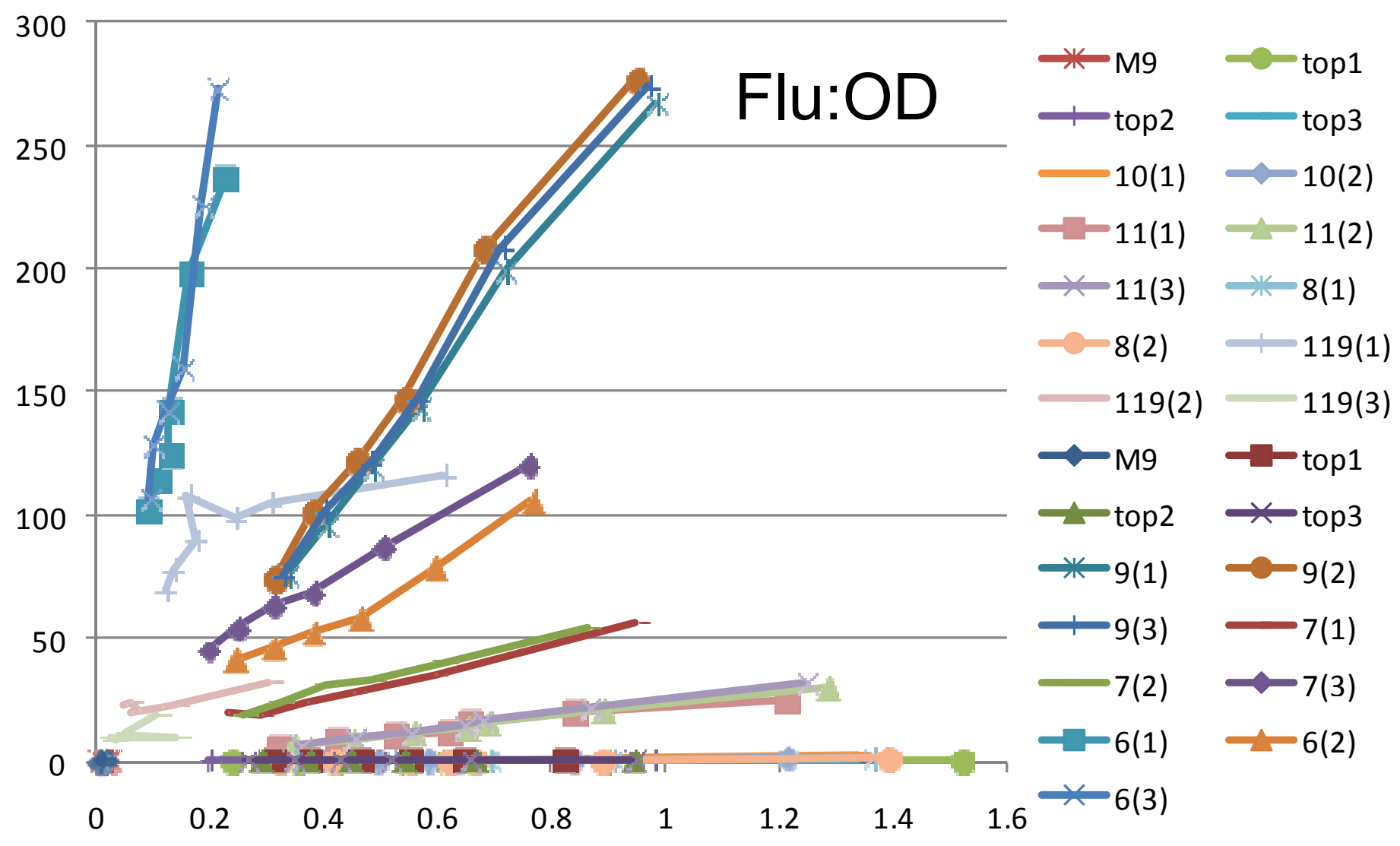

Flu:OD

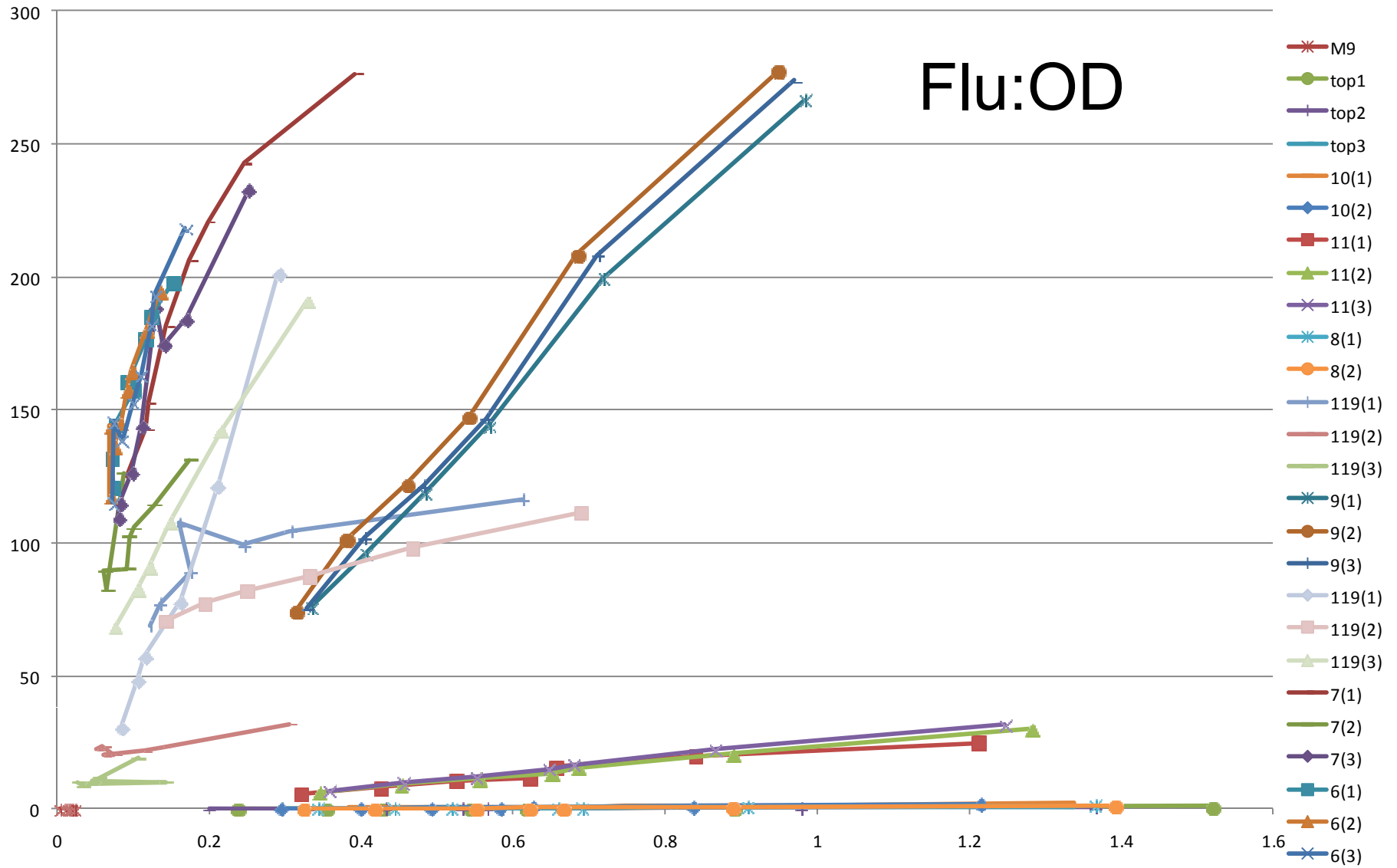

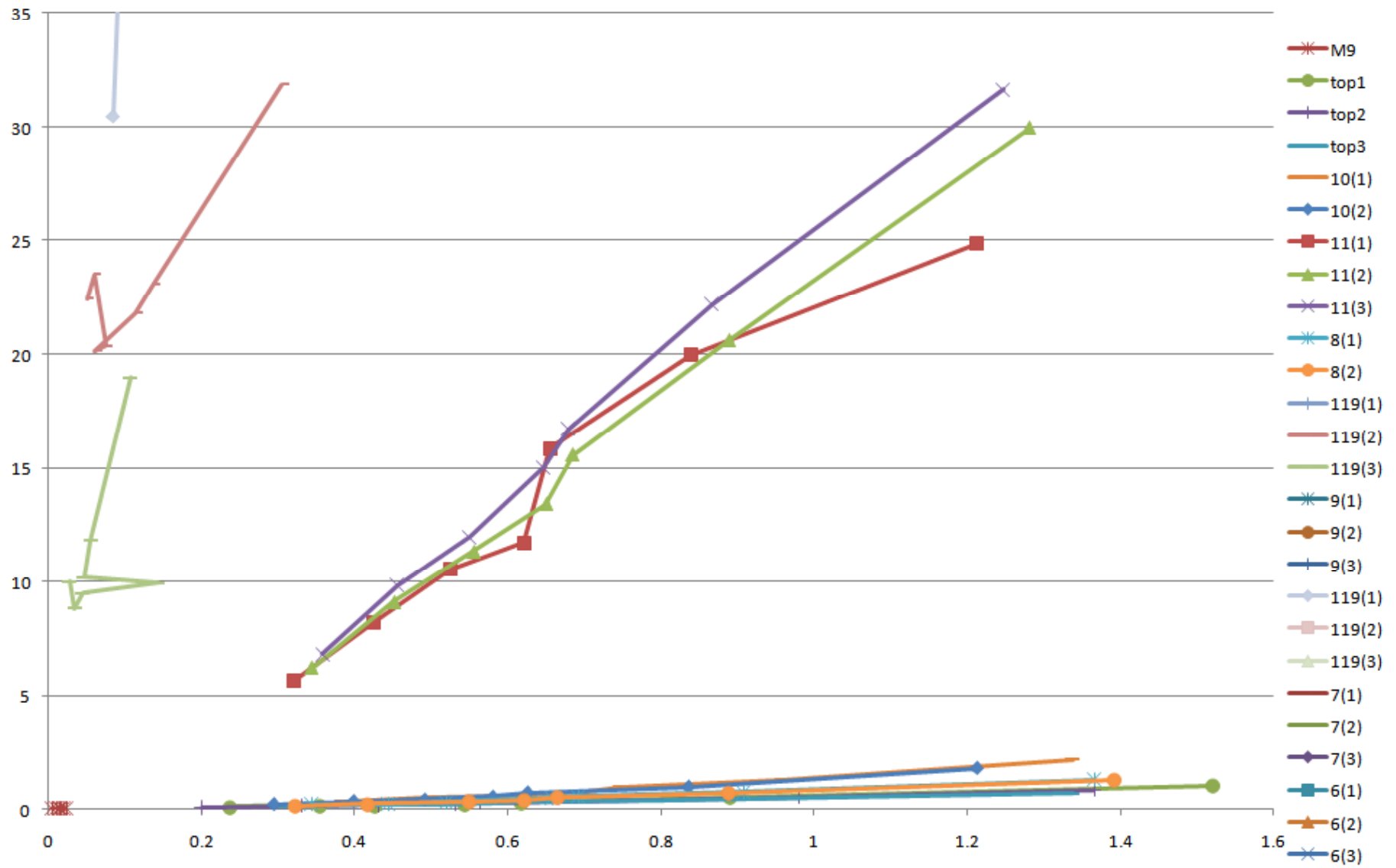

MDS42 recA Blue

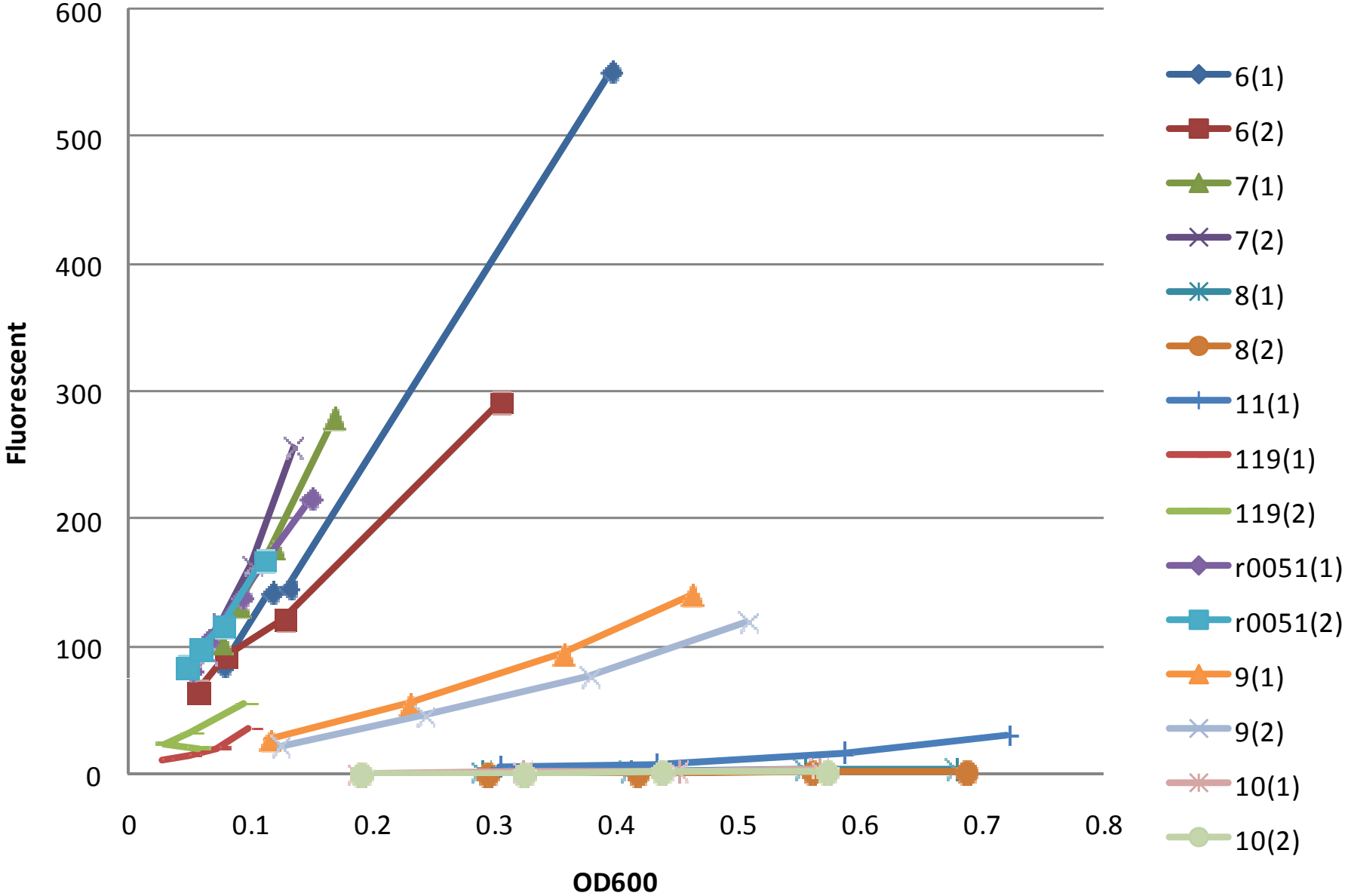

7

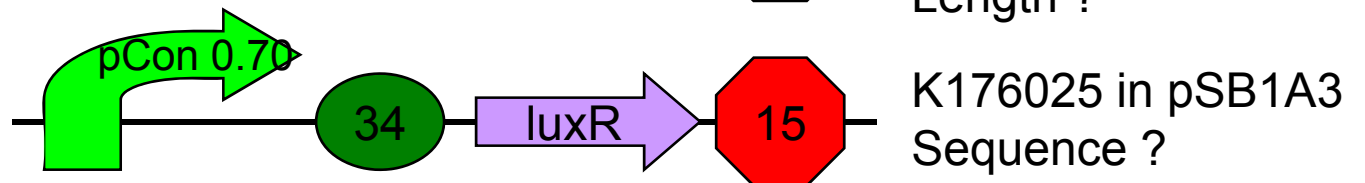
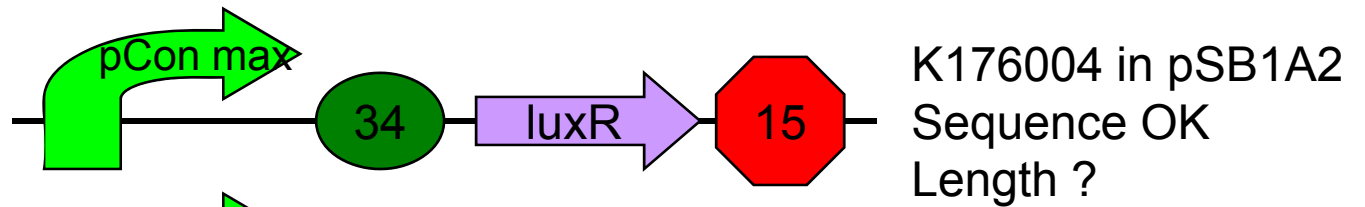
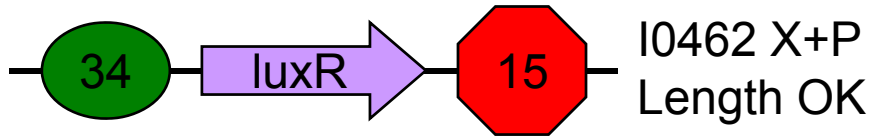
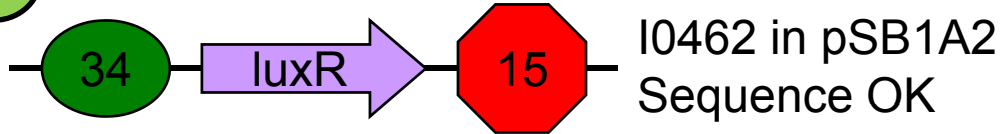

8

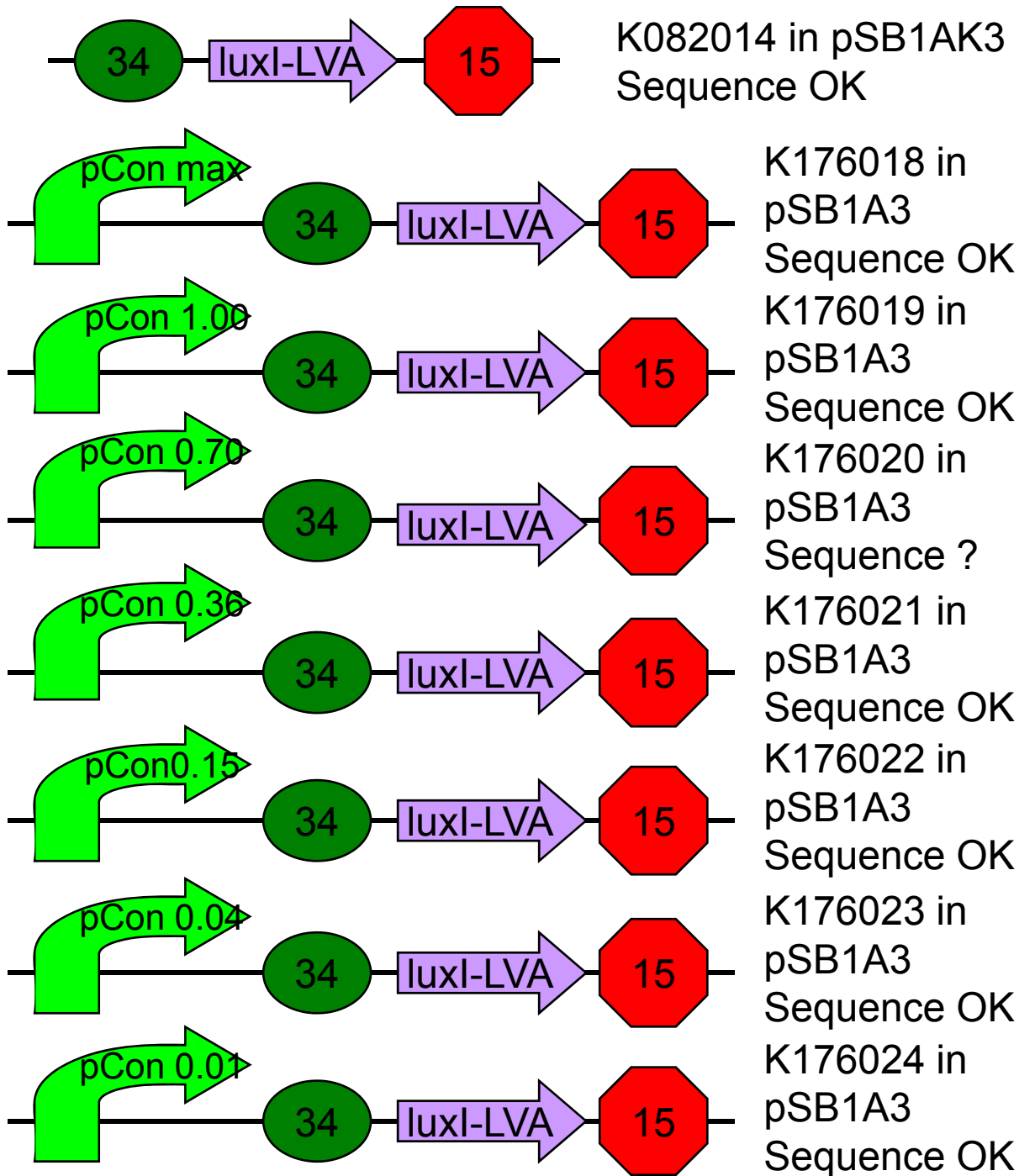

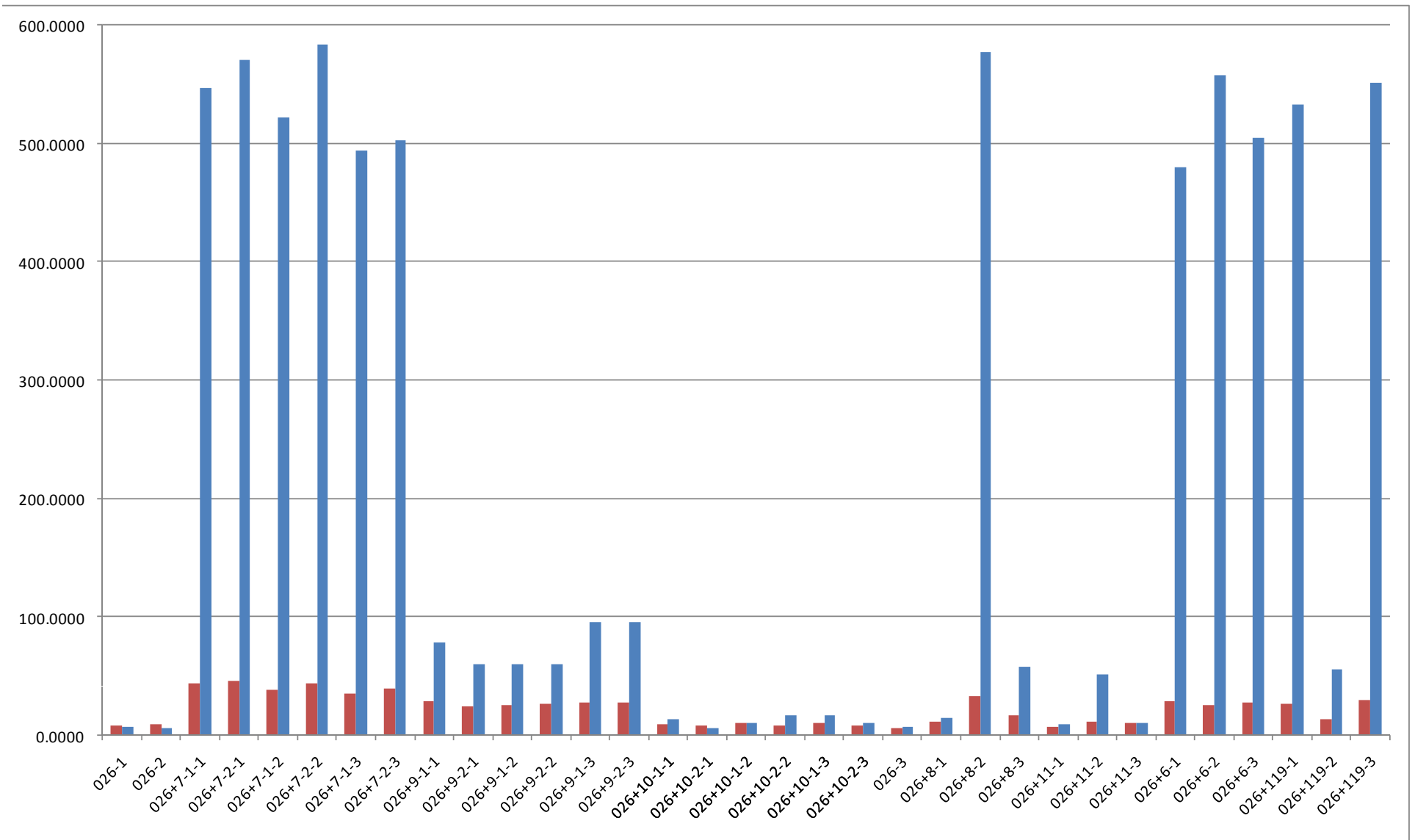

10+R+002 (K176003)

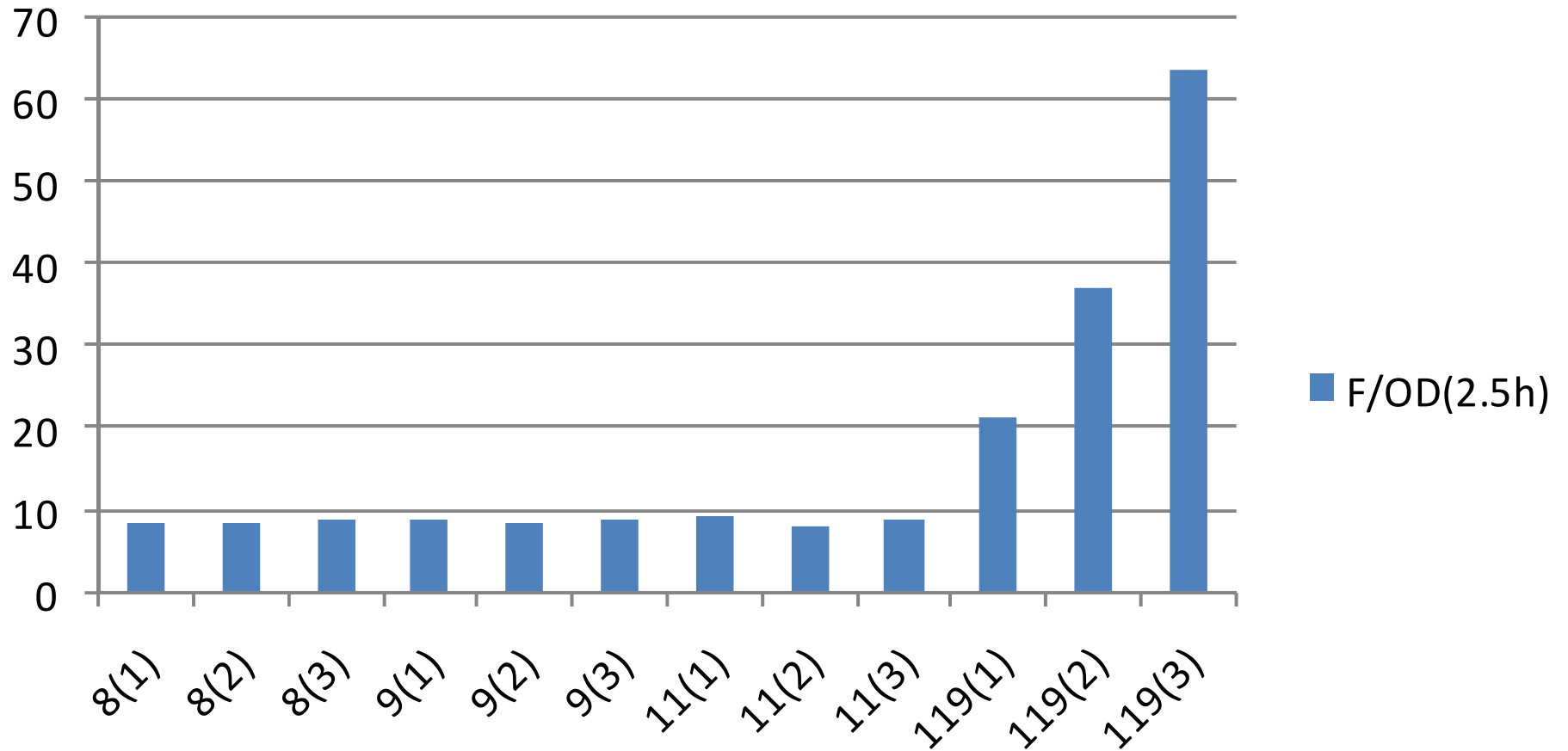

3

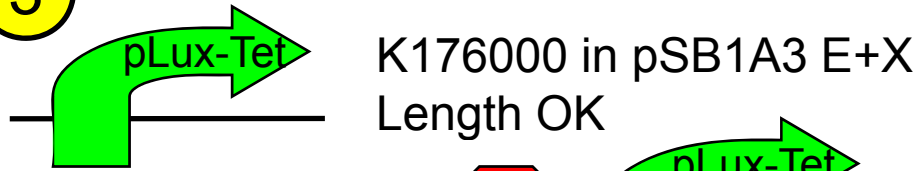

K176000 in pSB1A3 E+X
Length OK

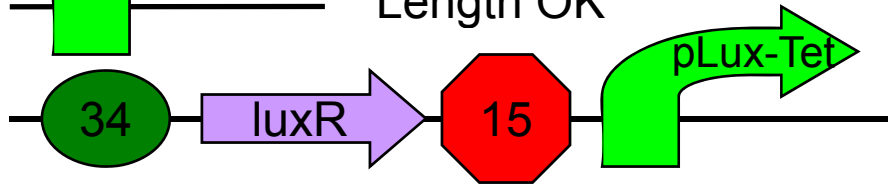

K176123 in pSB1A3
Sequence OK

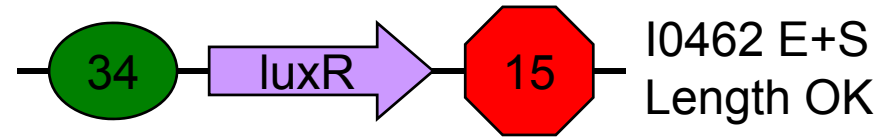

I0462 E+S
Length OK

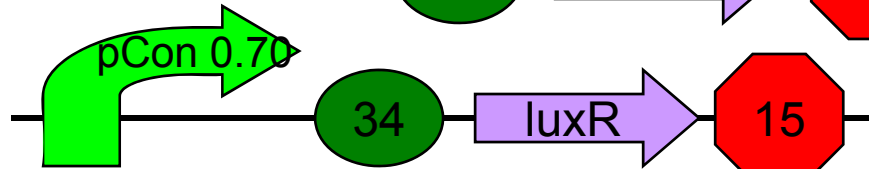

K176025 E+S
Length OK

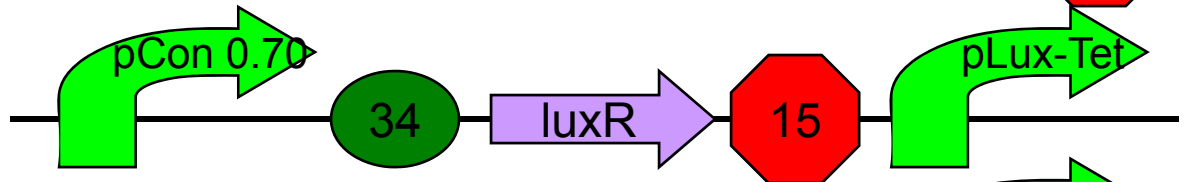

K176028 in pSB1A3
Sequence ?

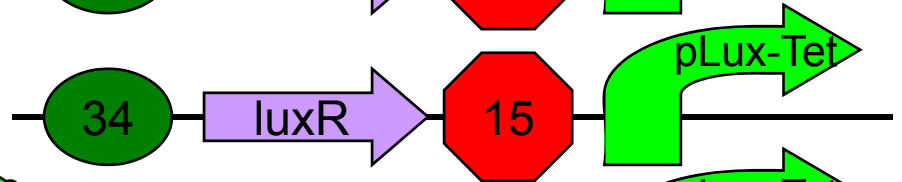

K176123 X+P
Length OK

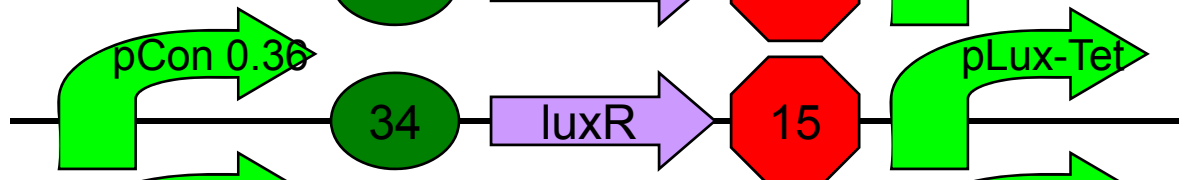

K176125 in pSB1A3
Ligation

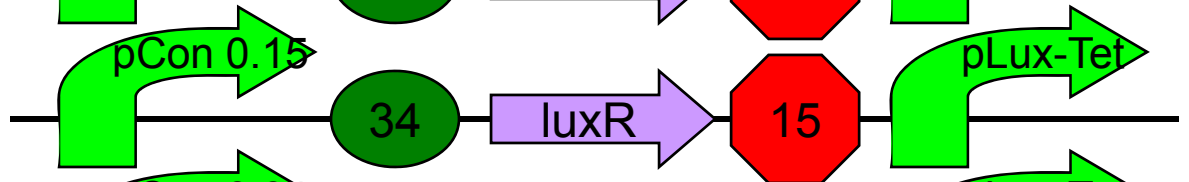

K176127 in pSB1A3
Sequence ?

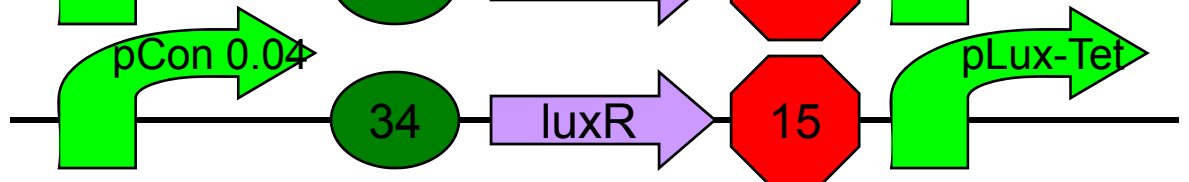

K176129 in pSB1A3
Sequencing

9

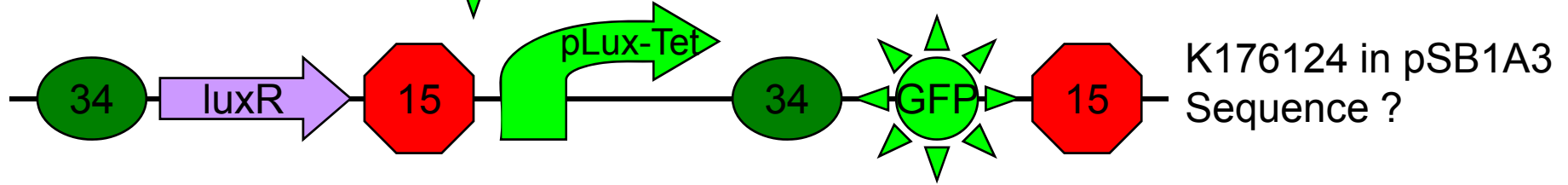
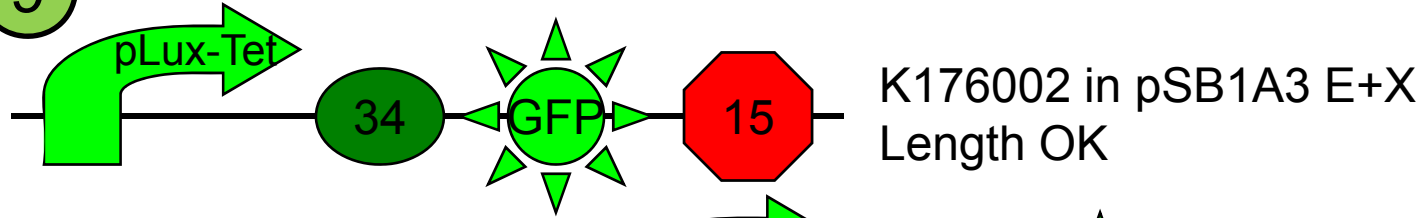

VRGFP G00201
Synthesis OK

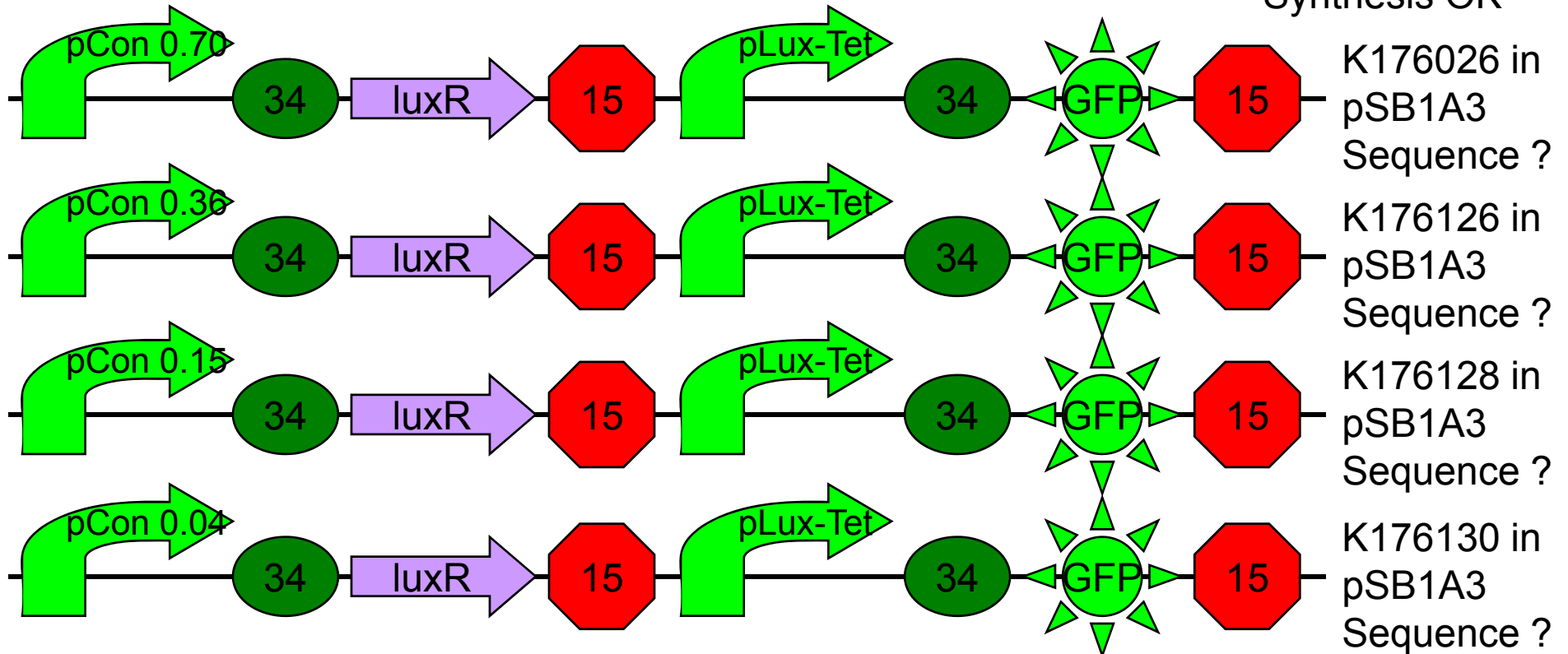

Methods

- Plate Reader
- Spectrophotometer

Flu/OD:t(min)

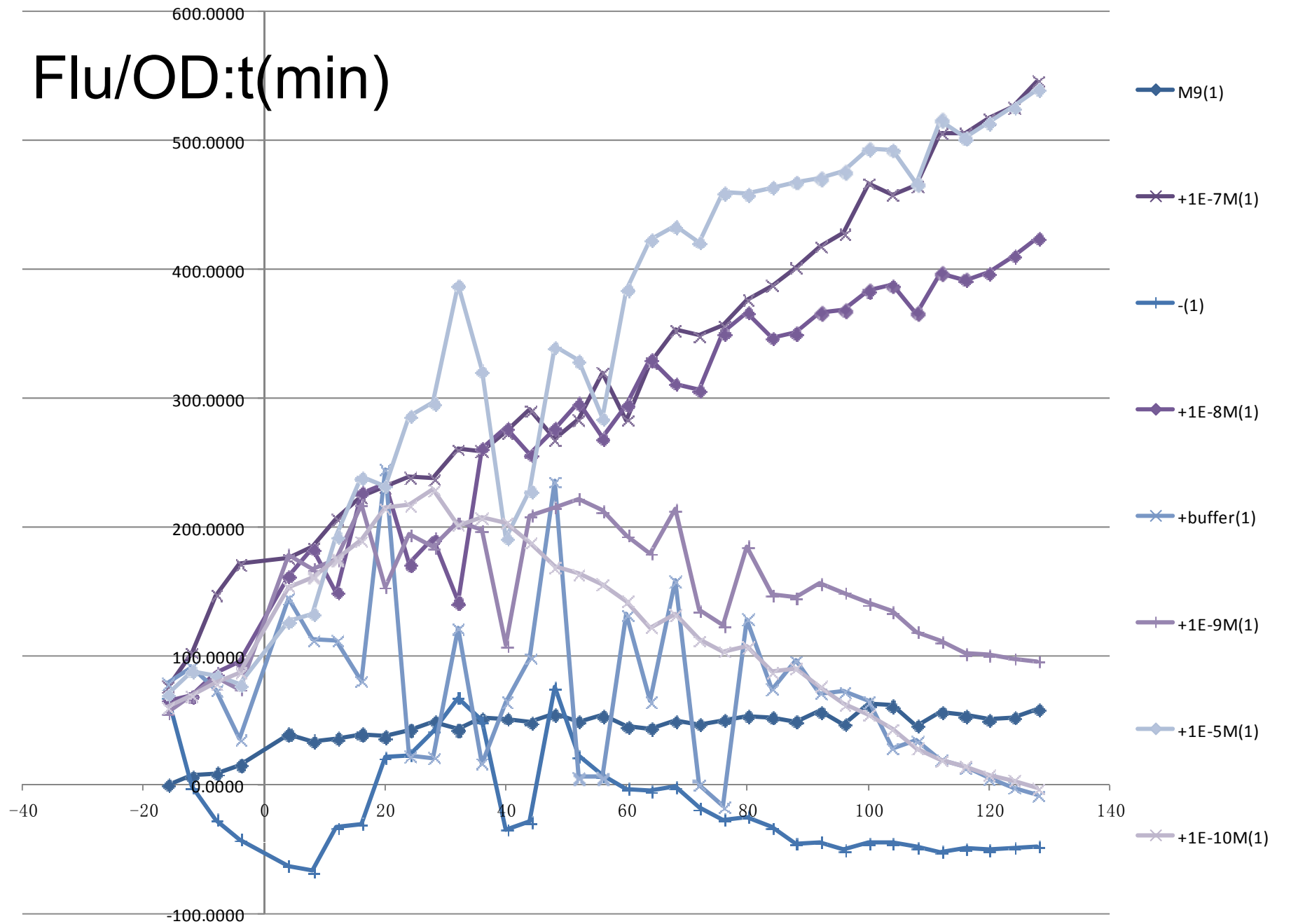

Flu/OD:t(min)

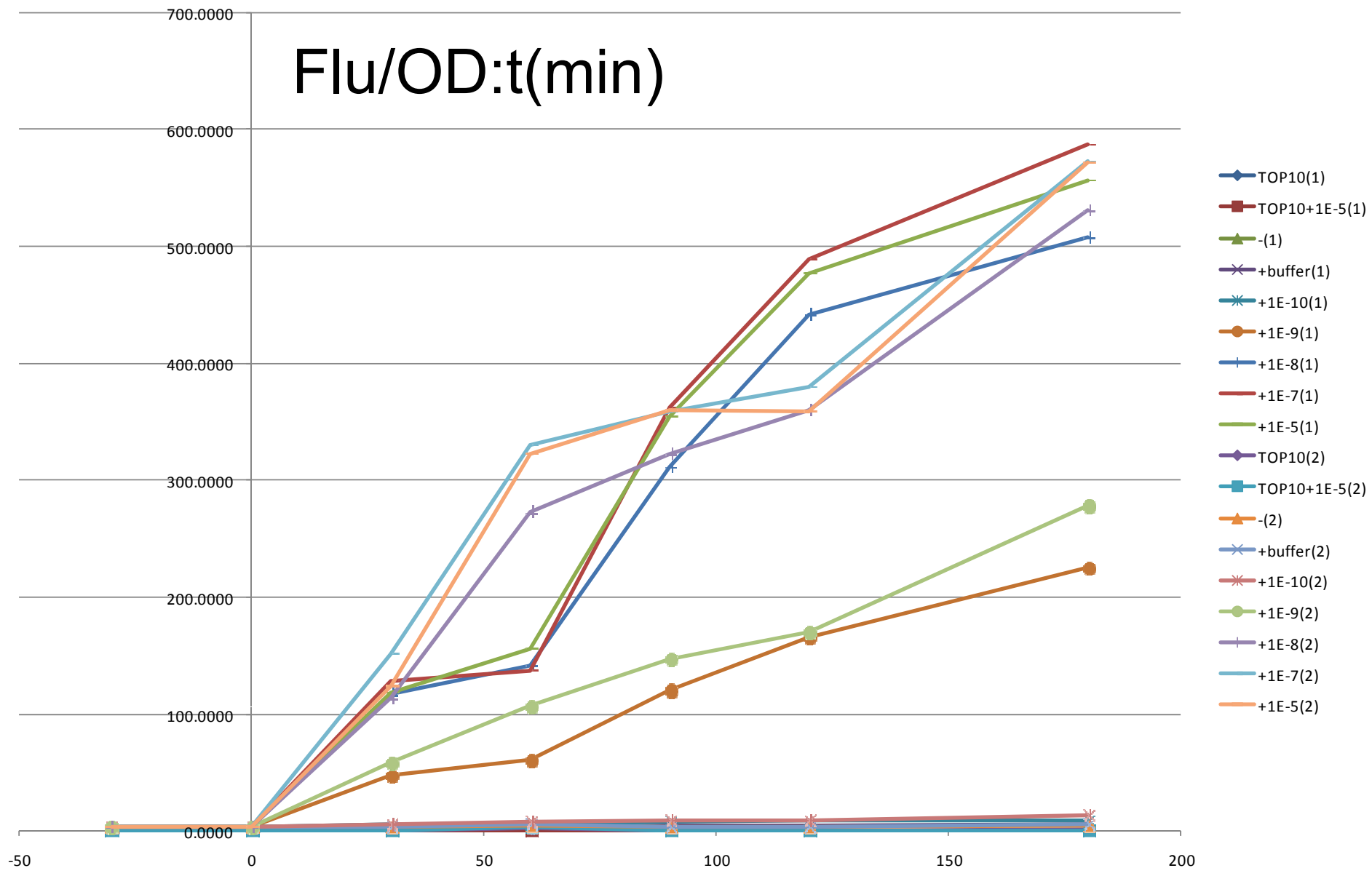

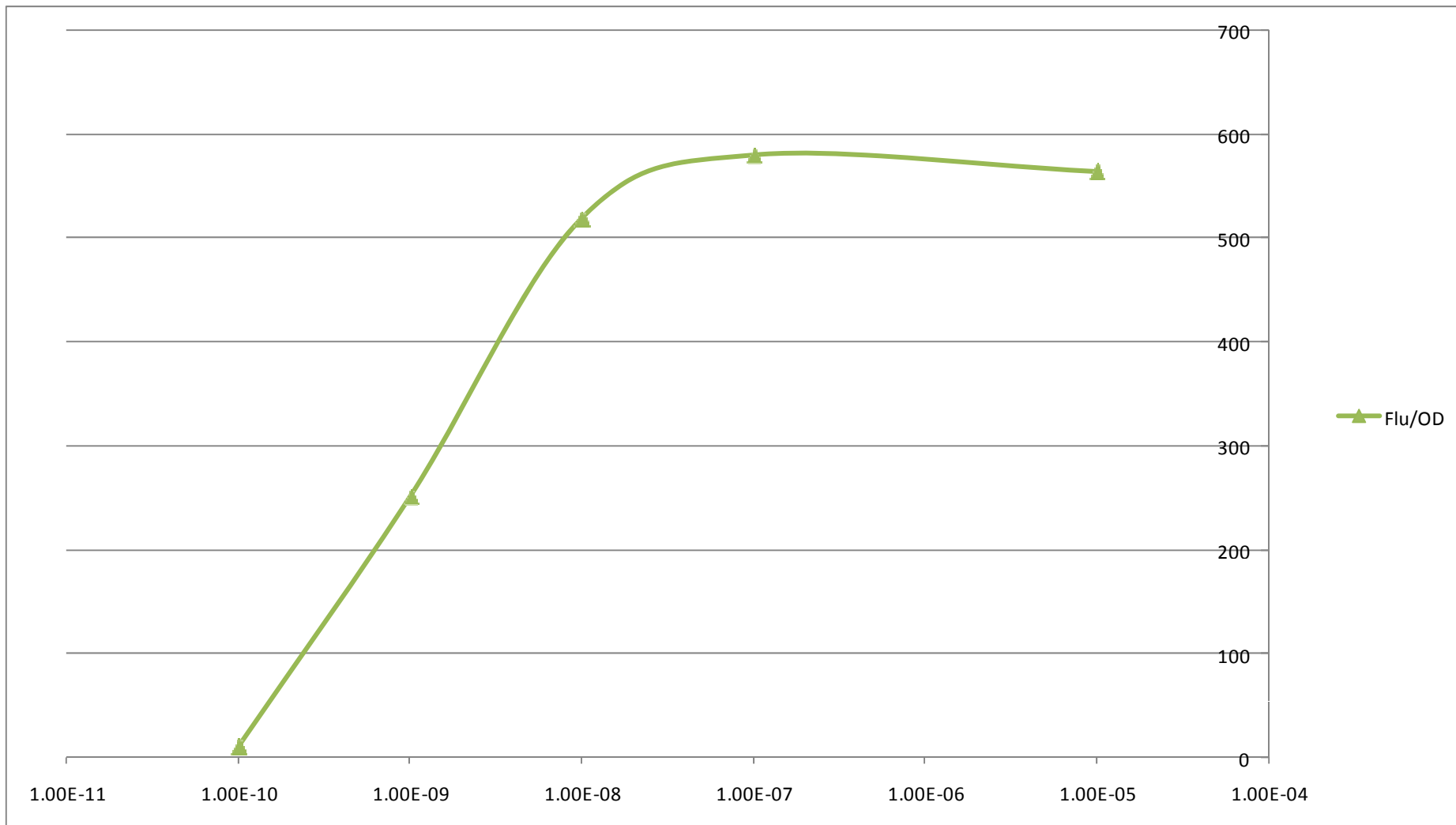

F2620

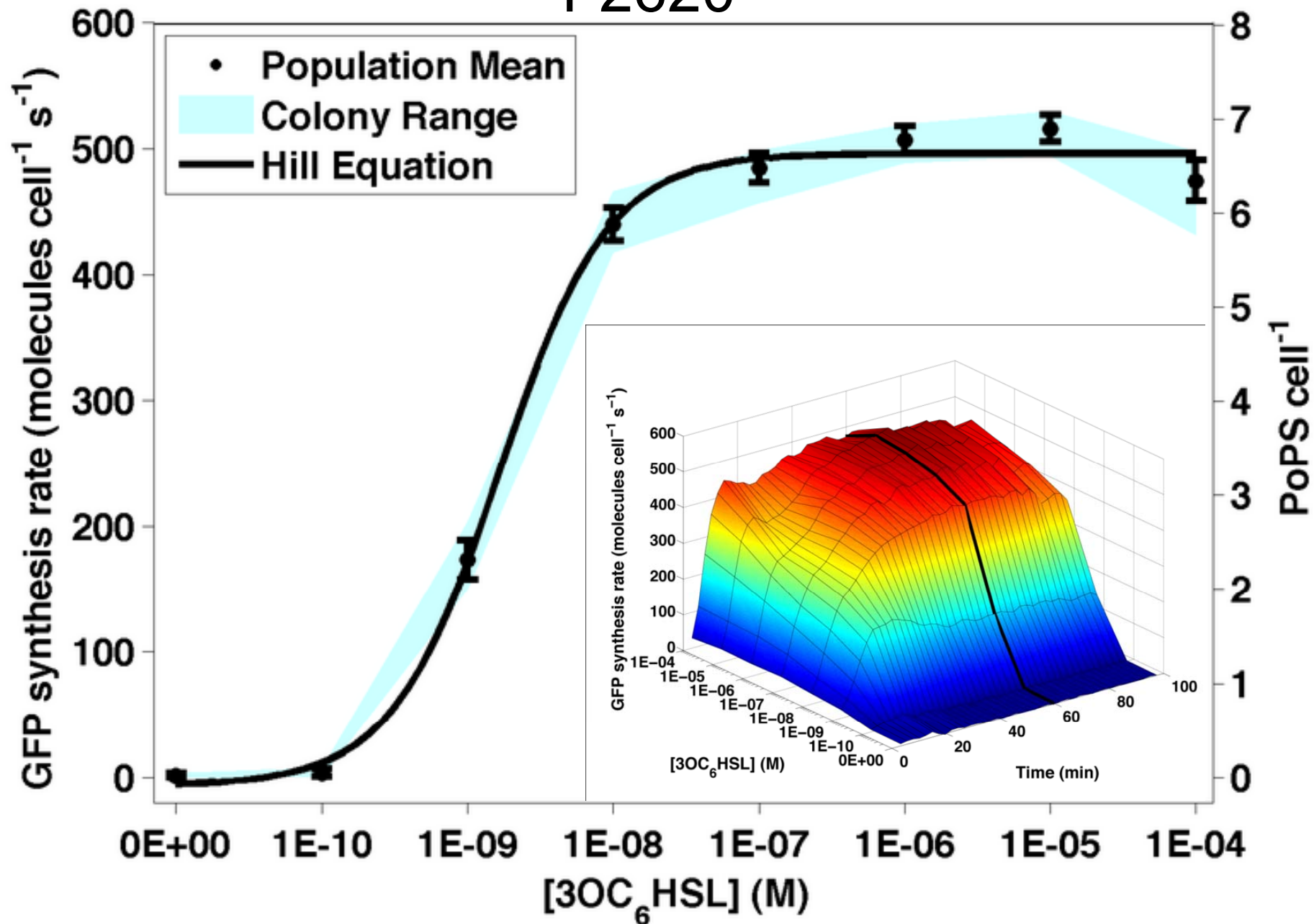

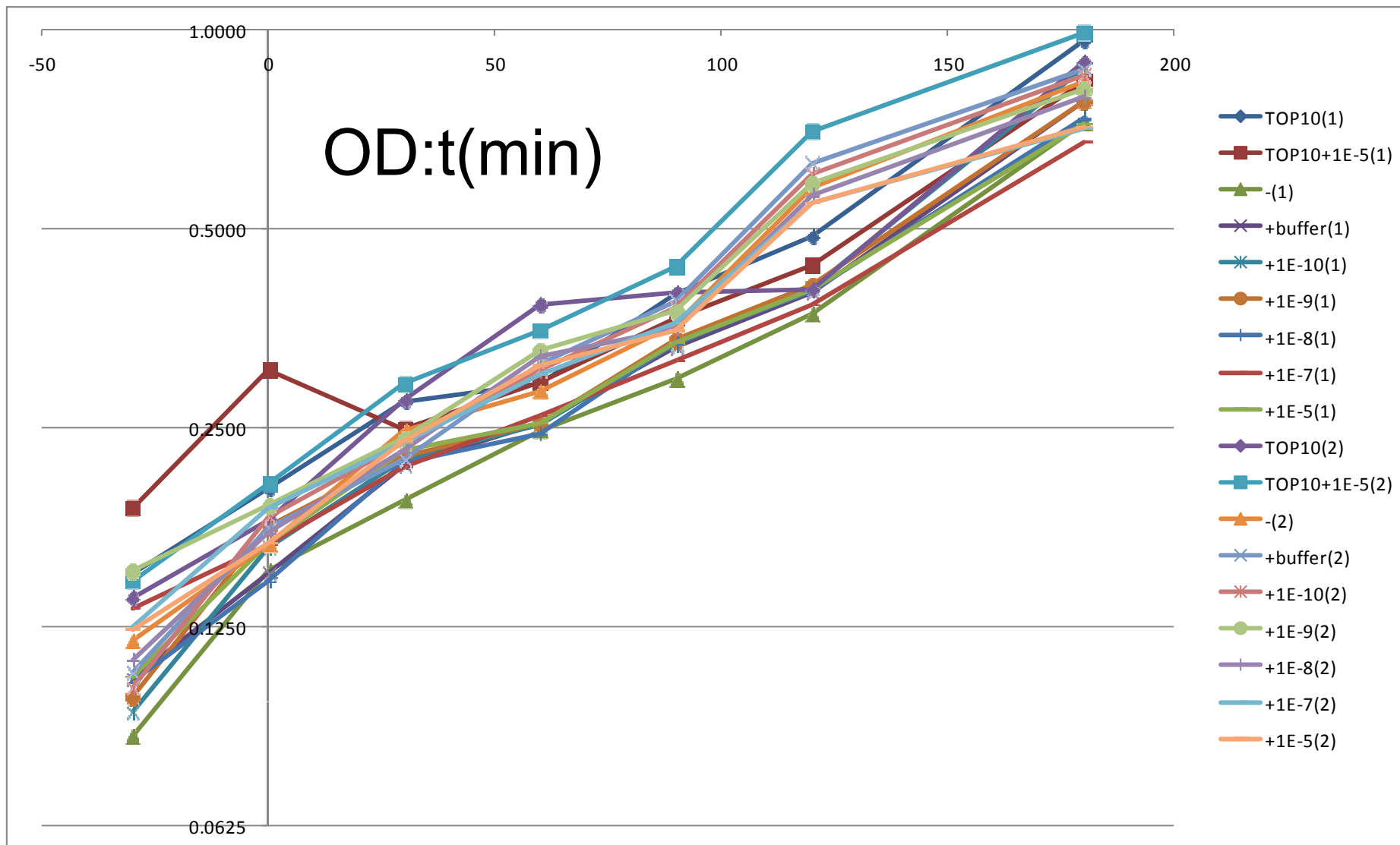

9+R+002 (K176126)

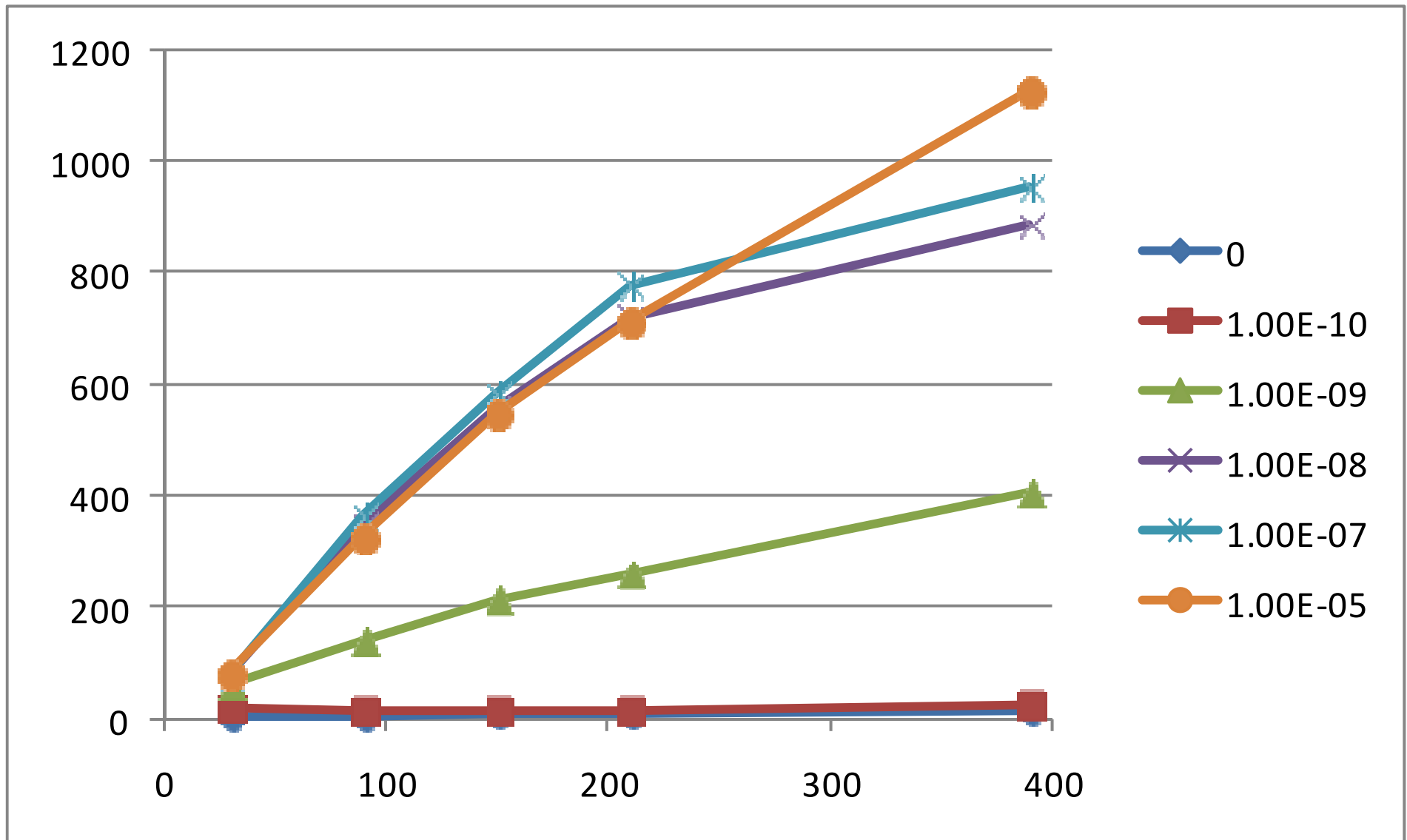

10+R+002 (K176130)

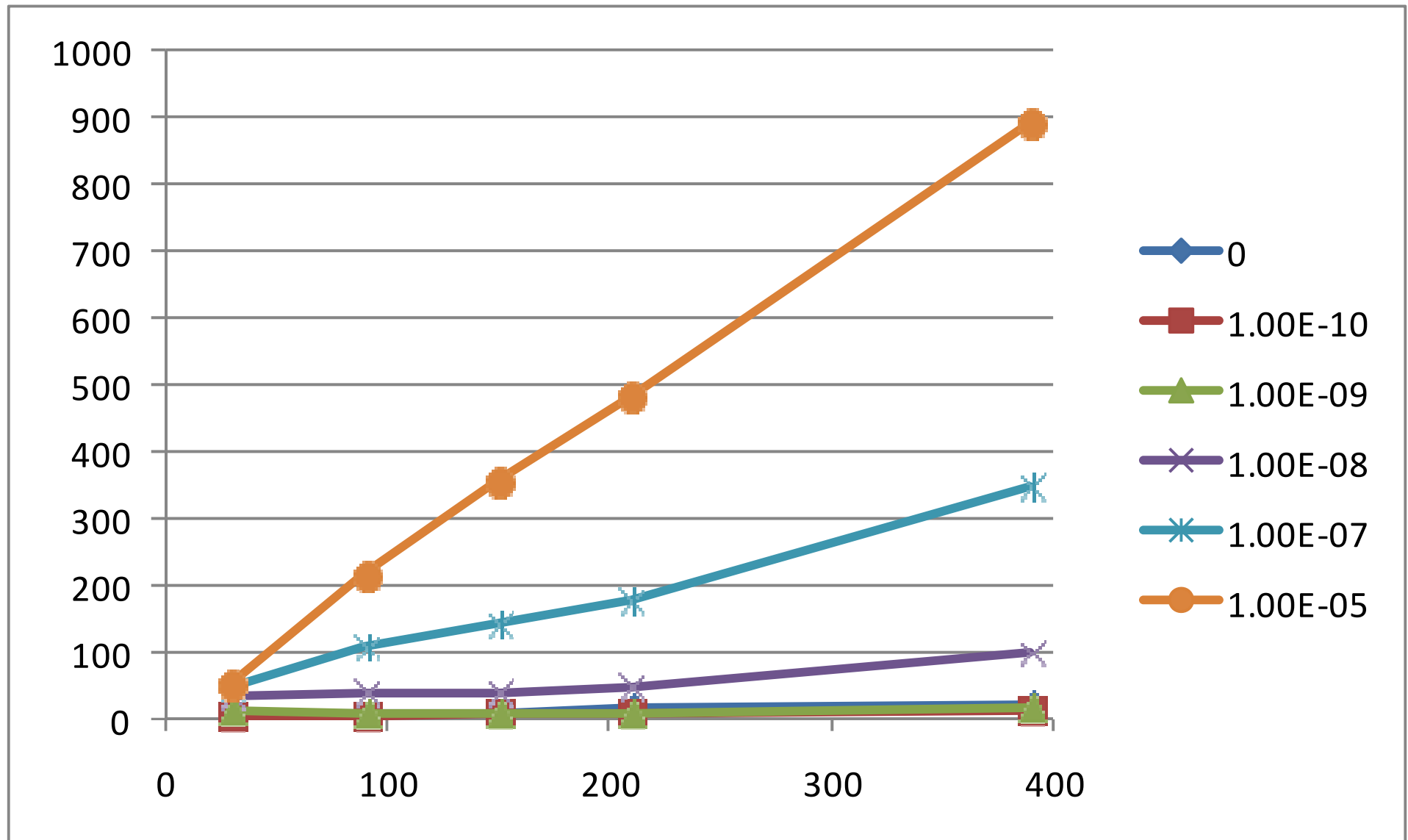

11+R+002 (K176128)

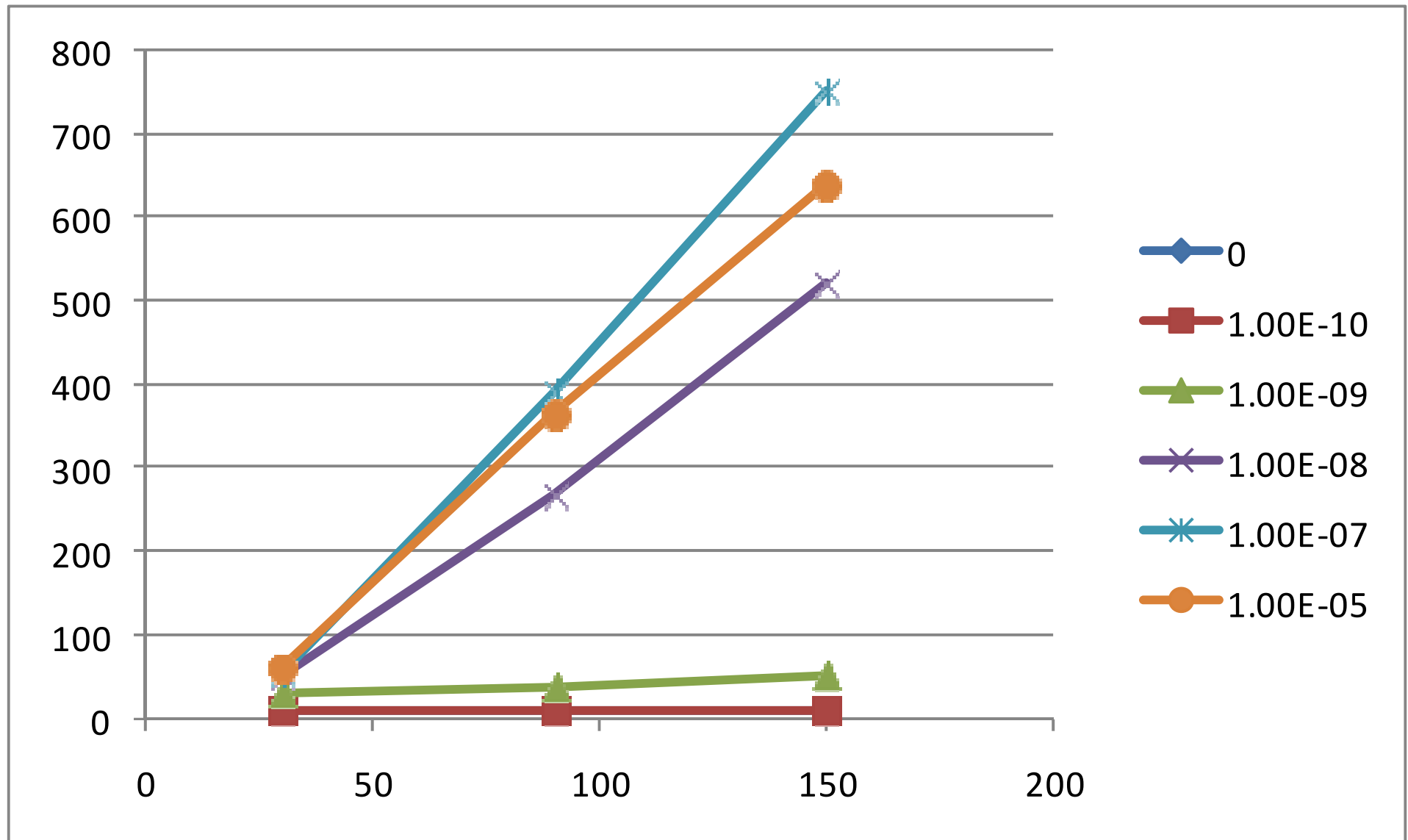

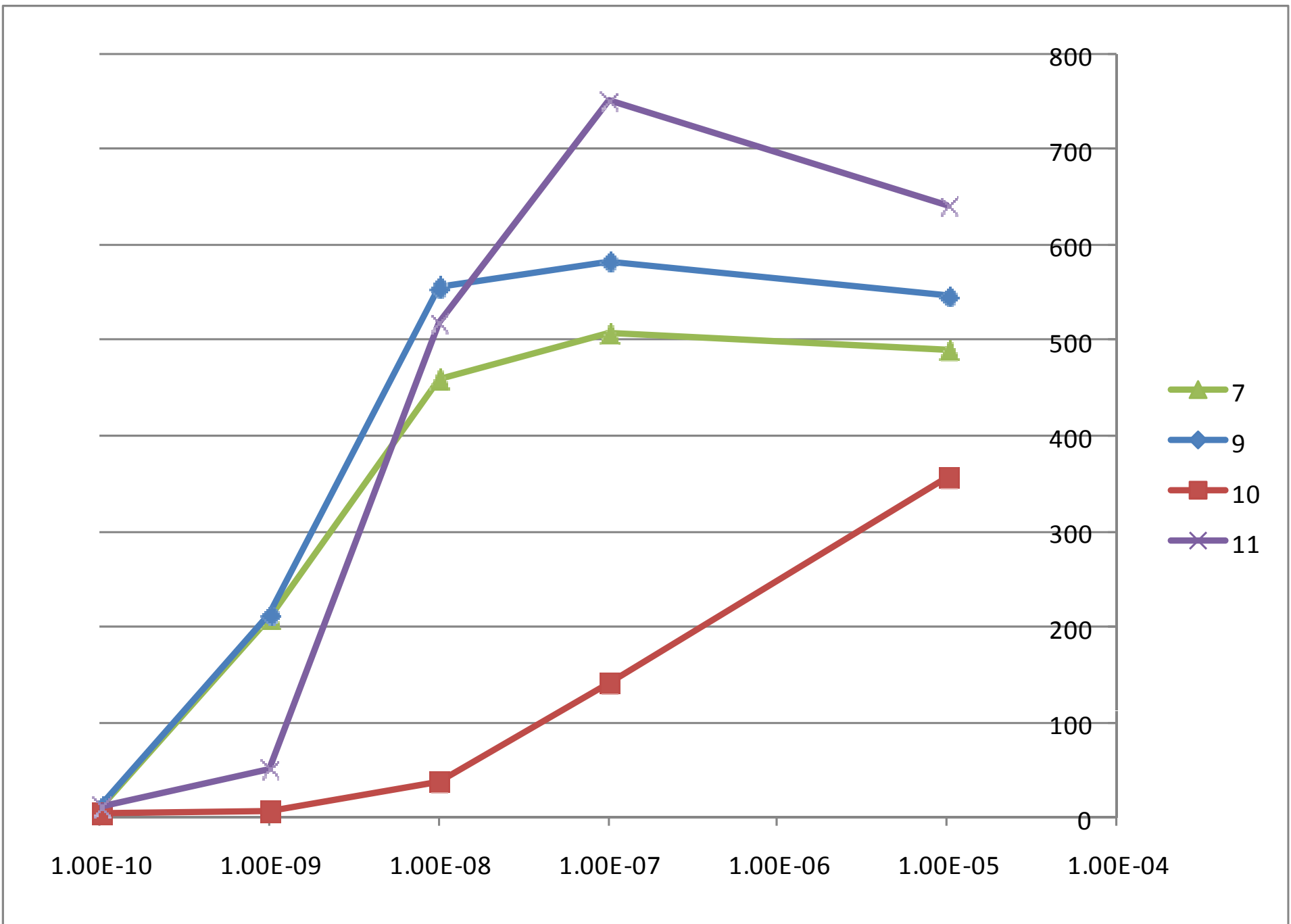

10

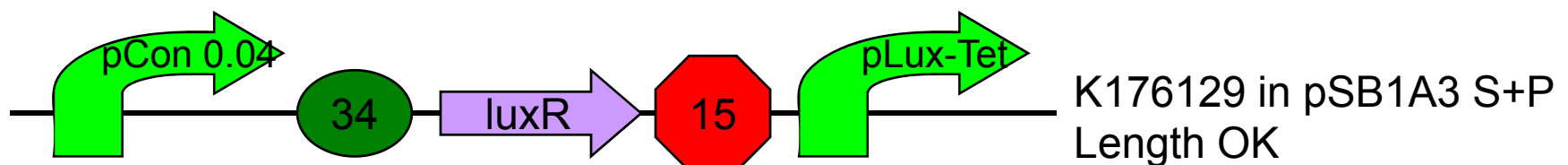
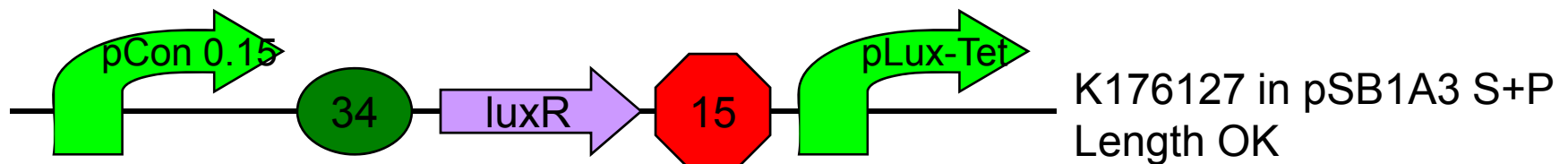
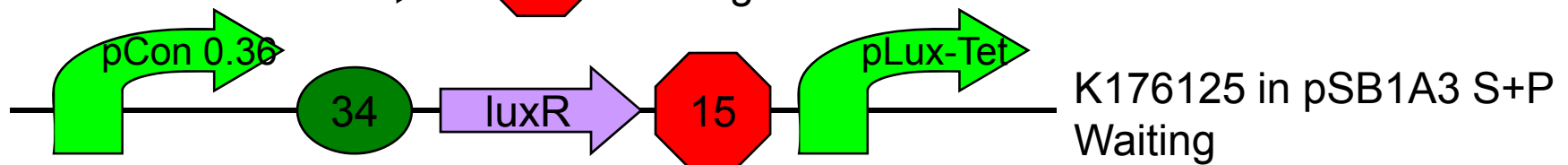
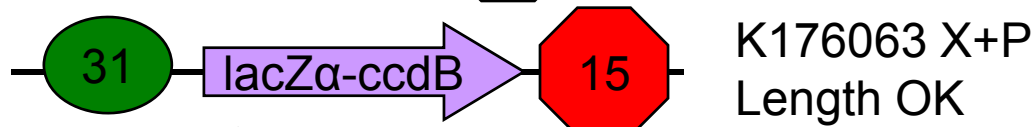
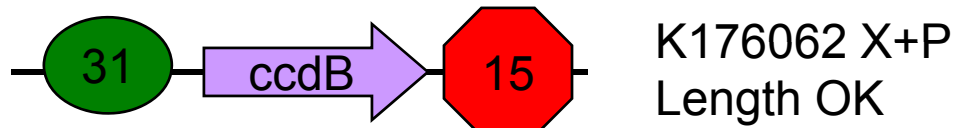
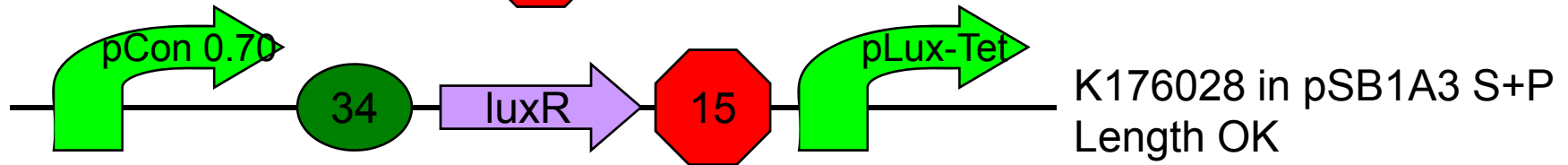
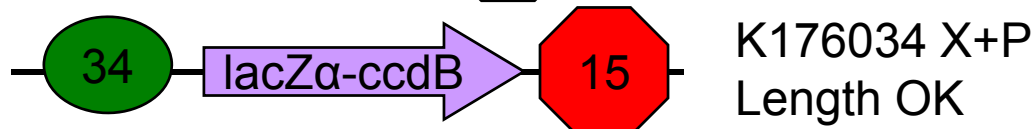
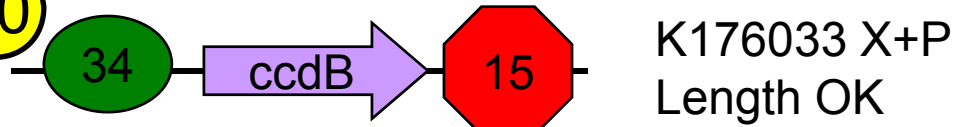

← VRccdB K176058
Synthesis OK

← M13-47 K176059
Synthesis OK

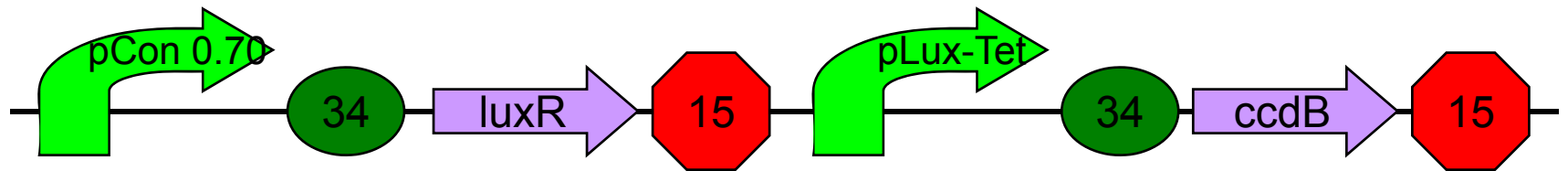

K176035 in pSB1A3 in DB3.1
Sequence ?

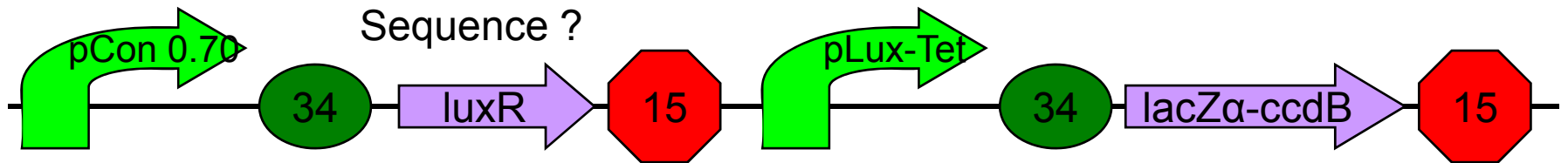

K176036 in pSB1A3 in DB3.1
Sequence OK

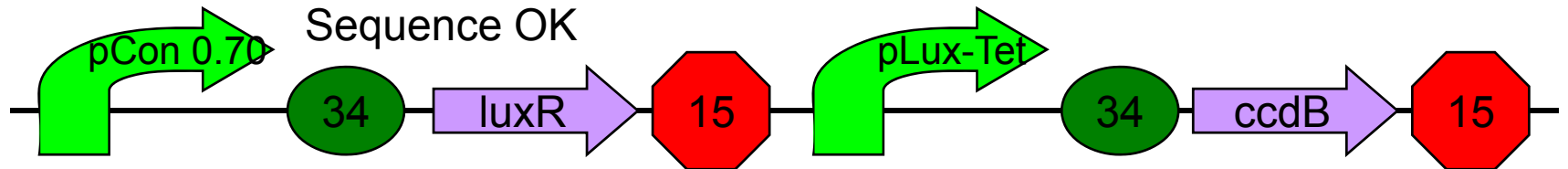

K176035 in pSB1A3 in TOP10
Transformation Fail

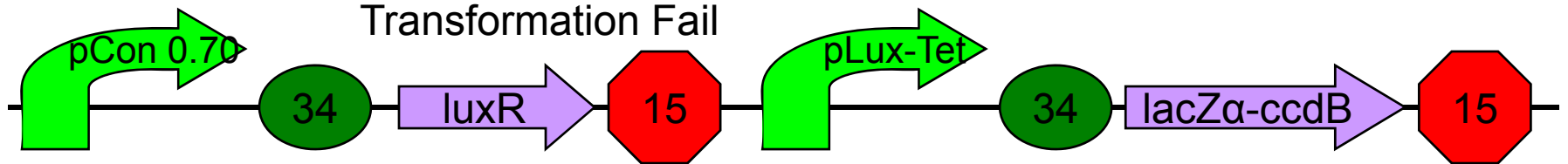

K176036 in pSB1A3 in TOP10
Transformation Fail

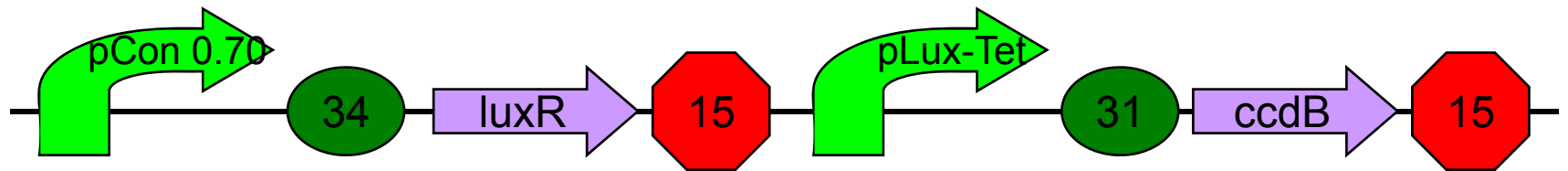

K176089 in pSB1A3 in DB3.1

Sequencing

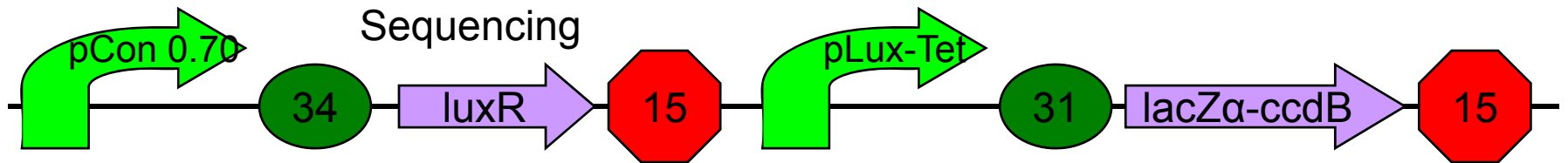

K176090 in pSB1A3 in DB3.1

Sequence ?

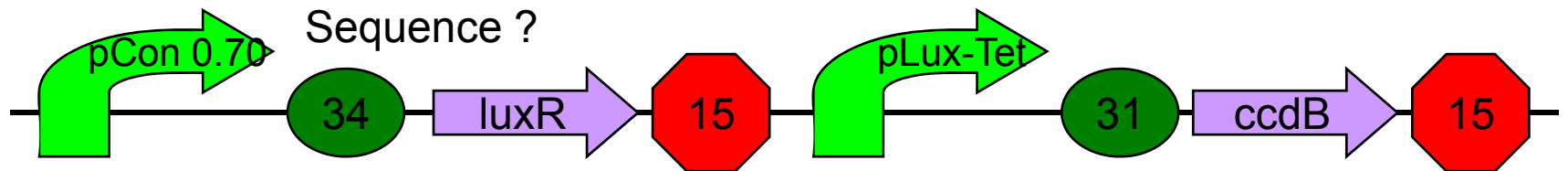

K176089 in pSB1A3 in TOP10

Transformation

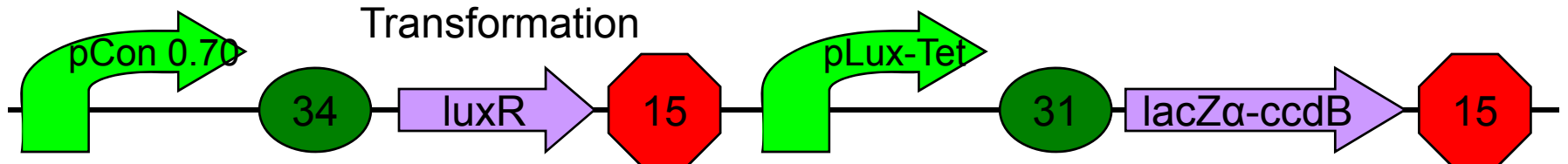

K176090 in pSB1A3 in TOP10

Transformation

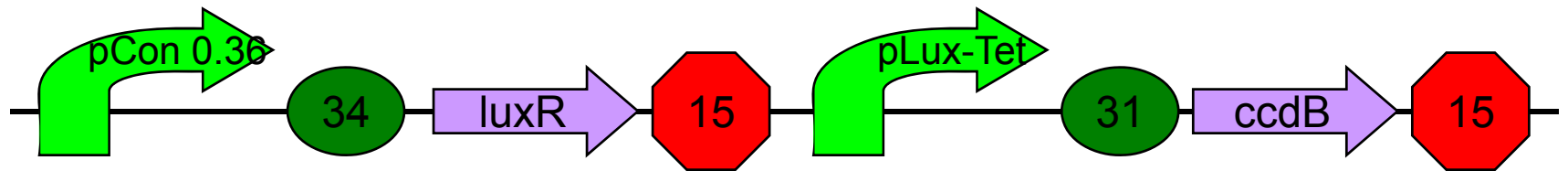

K176131 in pSB1A3 in DB3.1

Ligation

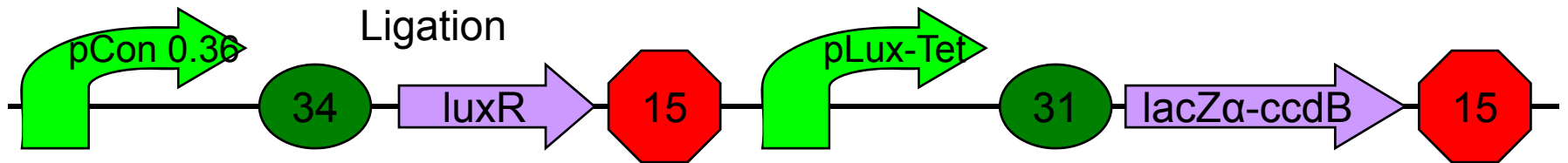

K176132 in pSB1A3 in DB3.1

Ligation

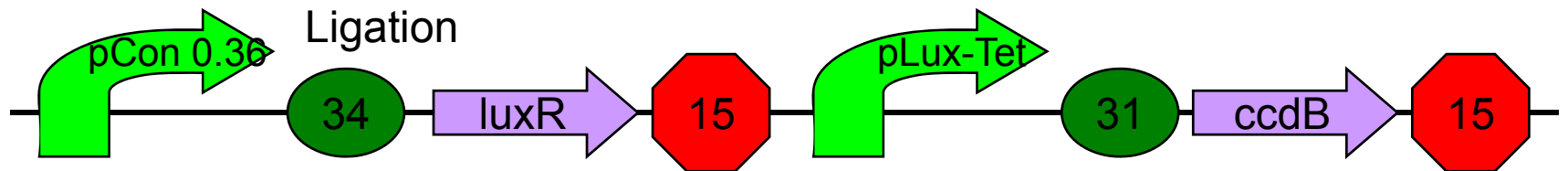

K176131 in pSB1A3 in MDS42rB

Waiting

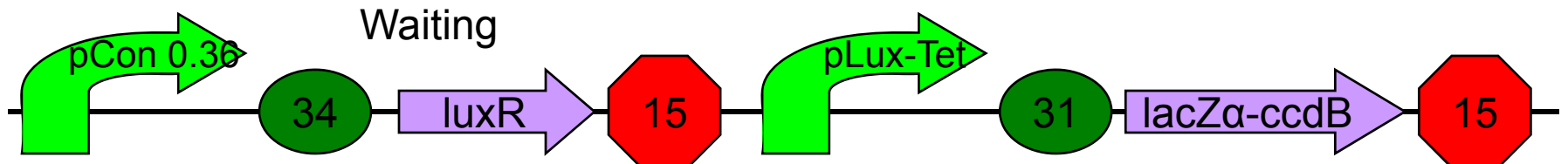

K176132 in pSB1A3 in MDS42rB

Waiting

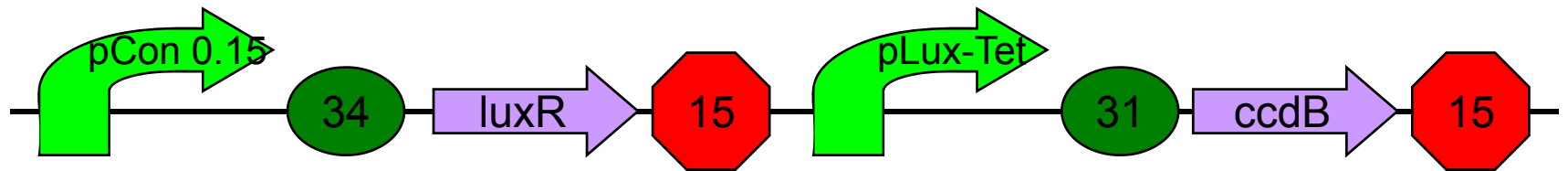

K176185 in pSB1A3 in DB3.1

Sequencing

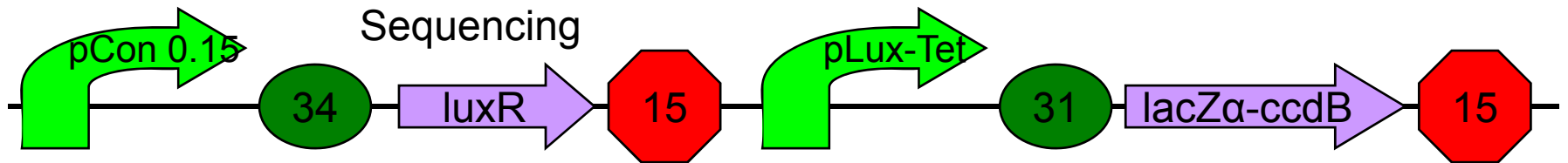

K176186 in pSB1A3 in DB3.1

Sequencing

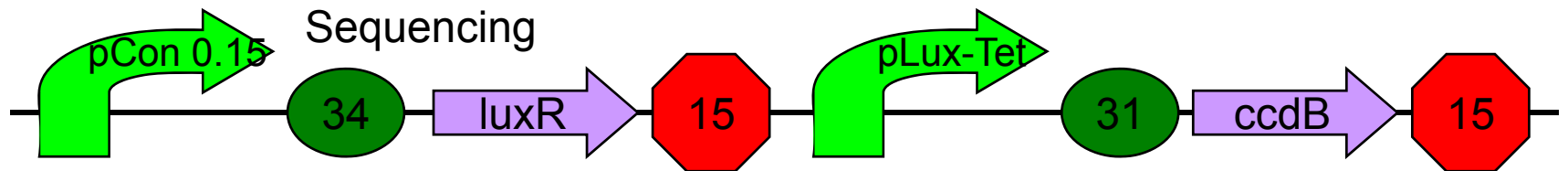

K176185 in pSB1A3 in MDS42rB

Transformation

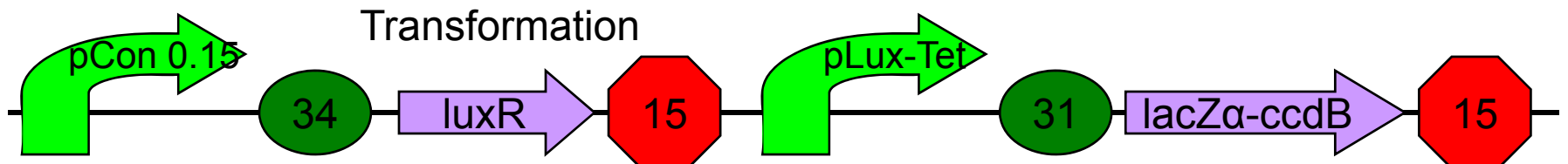

K176186 in pSB1A3 in MDS42rB

Transformation

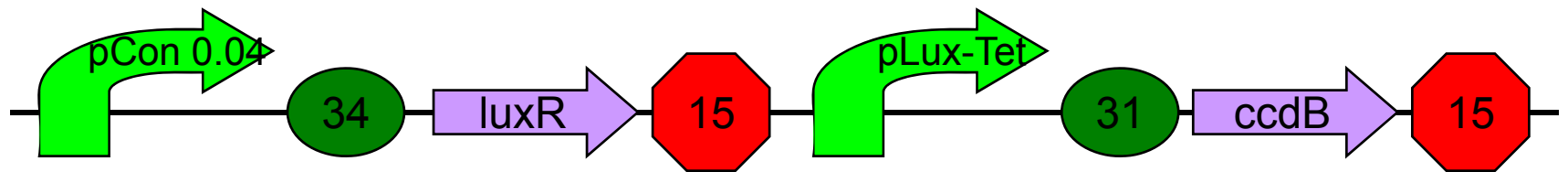

K176187 in pSB1A3 in DB3.1

Sequencing

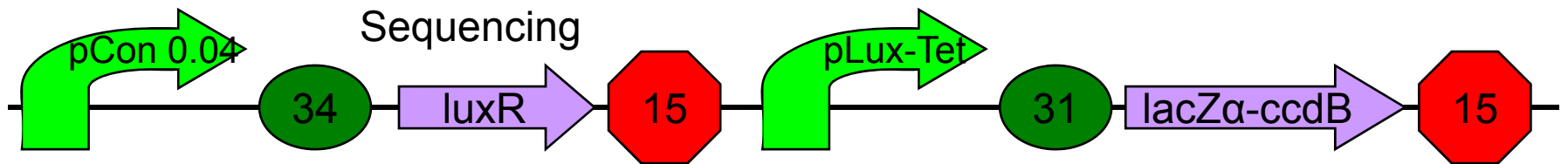

K176188 in pSB1A3 in DB3.1

Sequencing

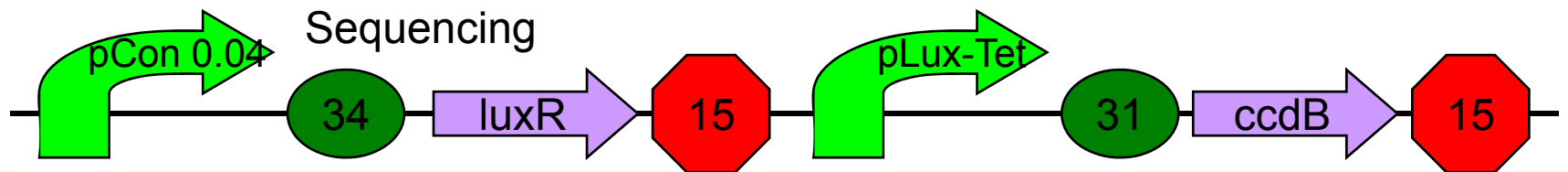

K176187 in pSB1A3 in MDS42rB

Transformation

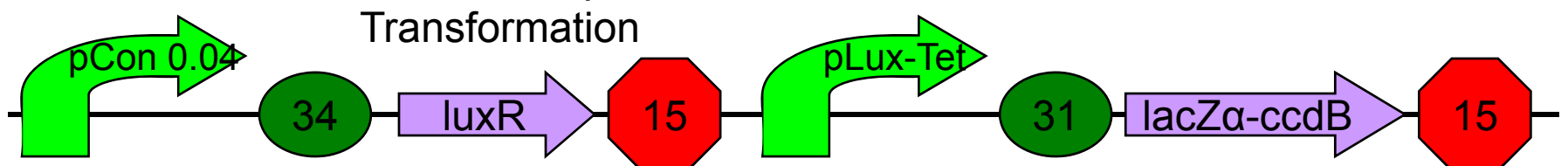

K176188 in pSB1A3 in MDS42rB

Transformation

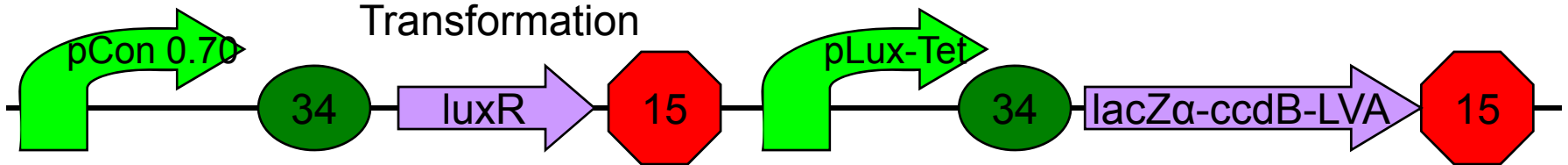
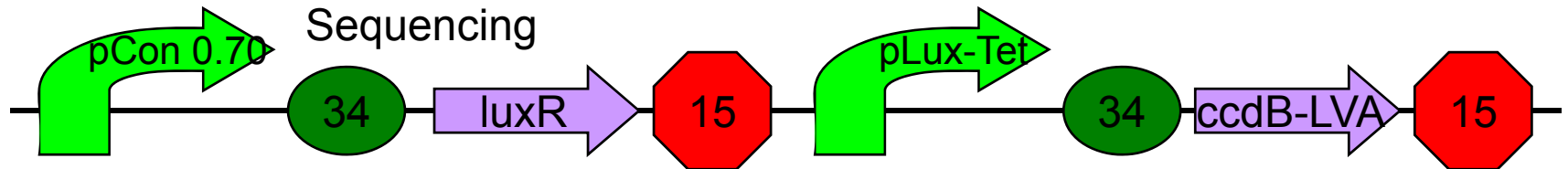
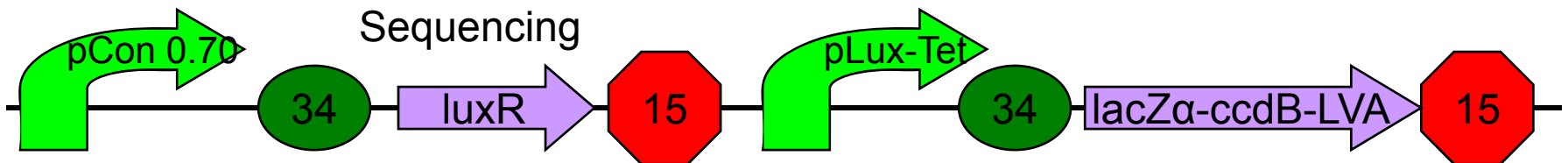
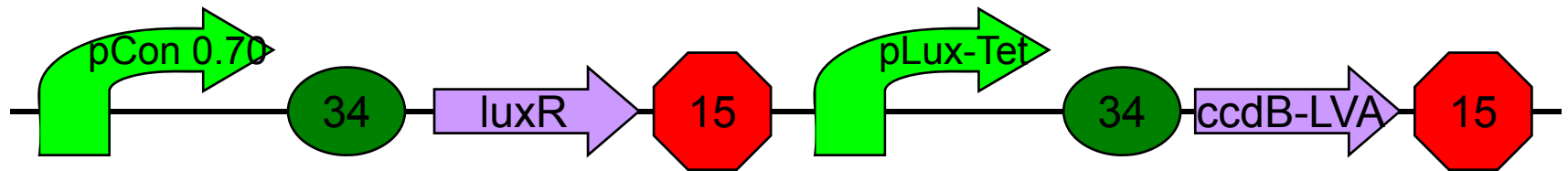
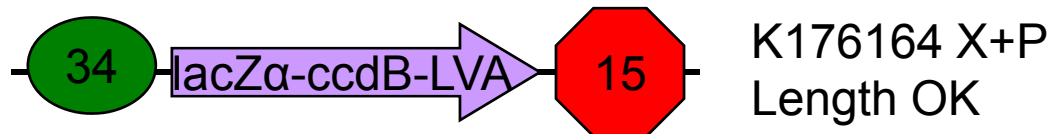
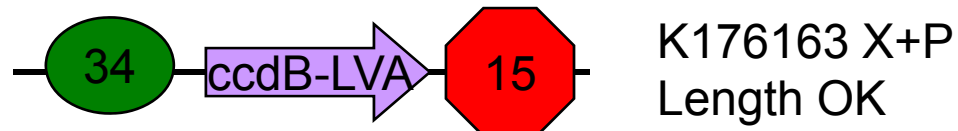

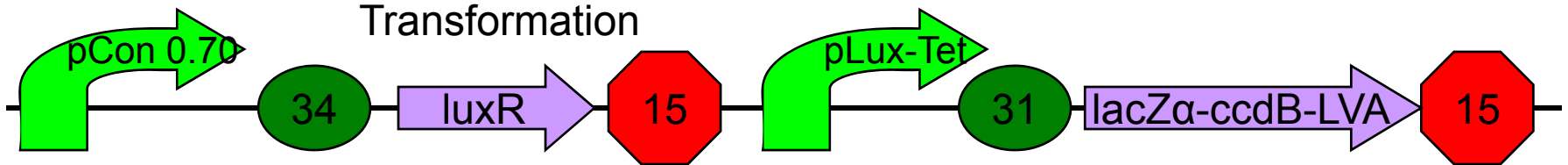
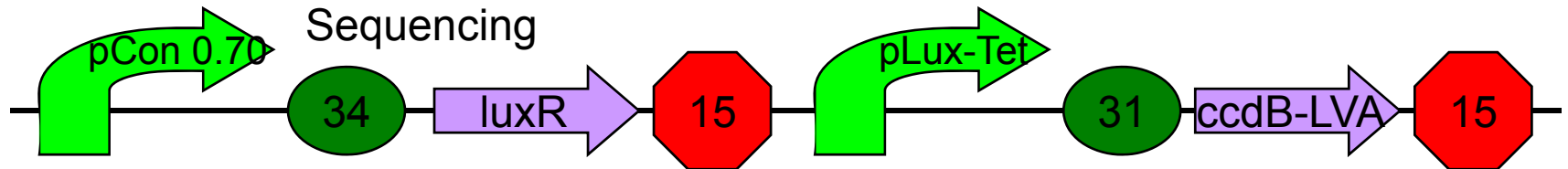
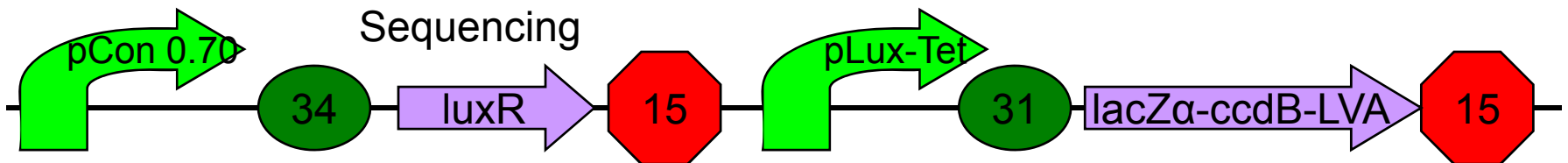
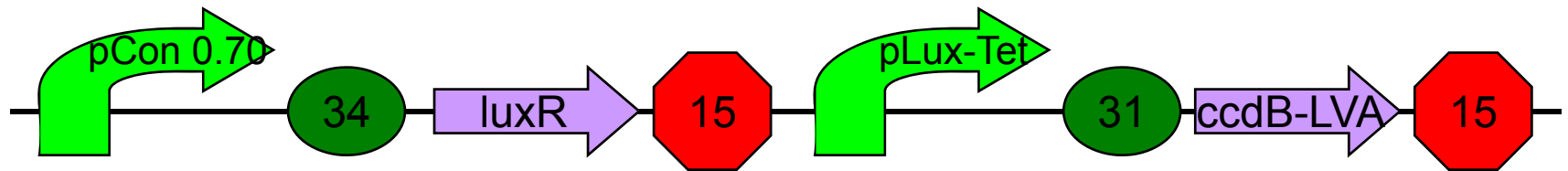
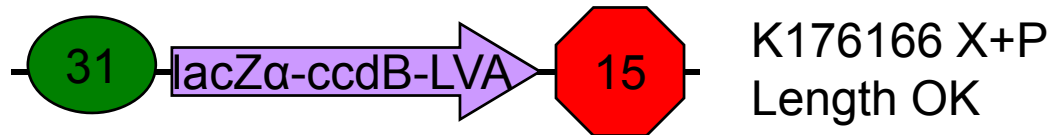
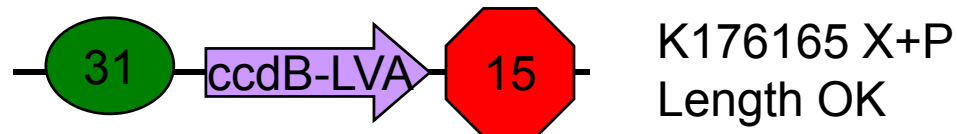

11

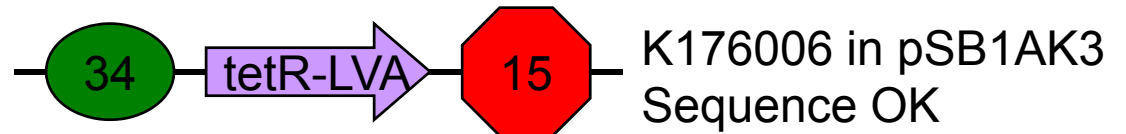
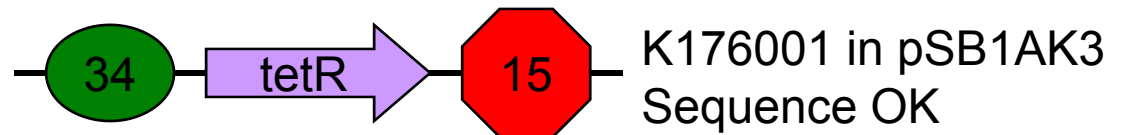
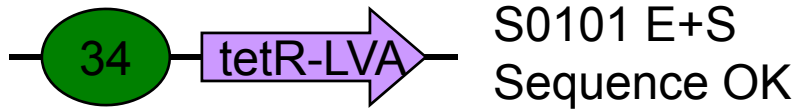
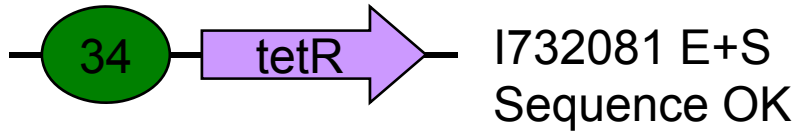
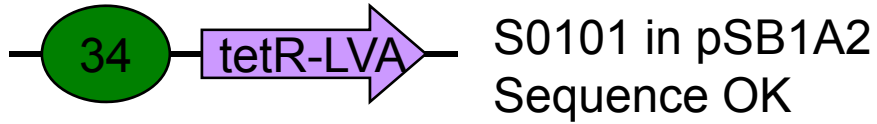
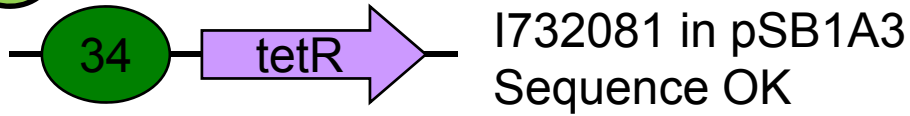

12

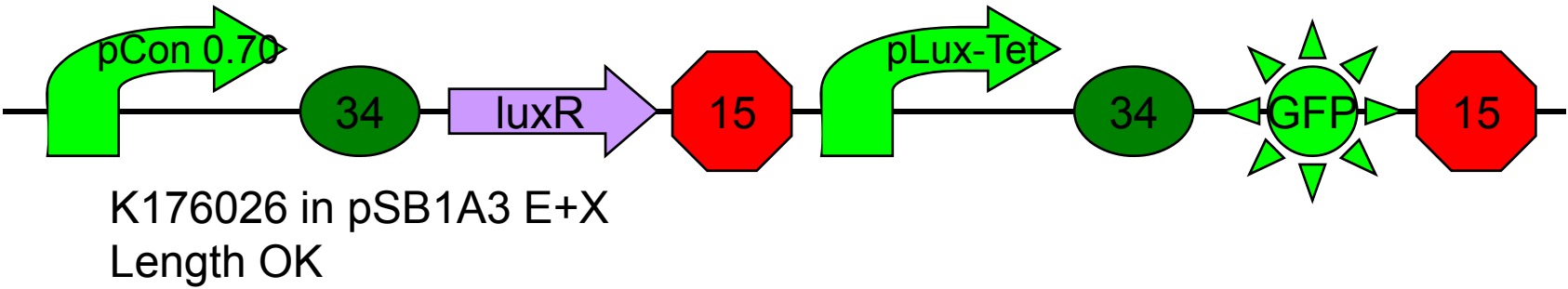
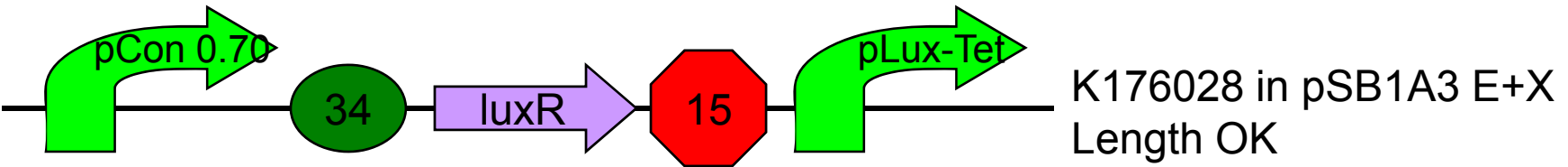
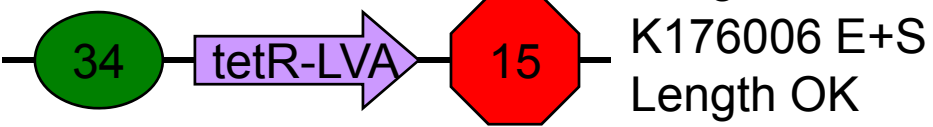
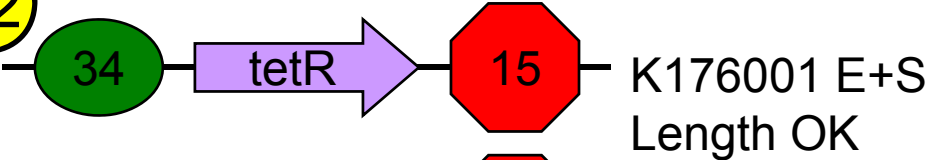



K176057
Synthesis OK

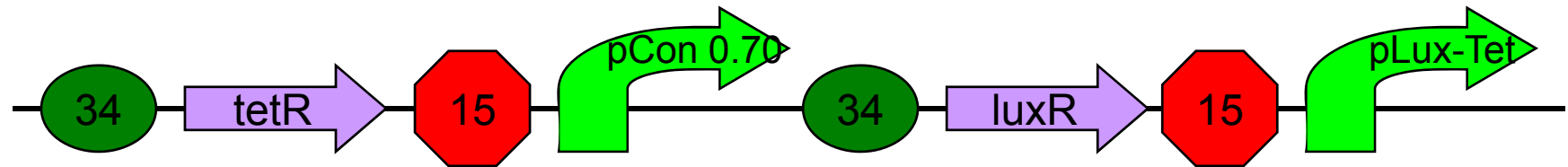

K176031 in pSB1A3
Sequence OK

K176032 in pSB1A3
Sequence OK

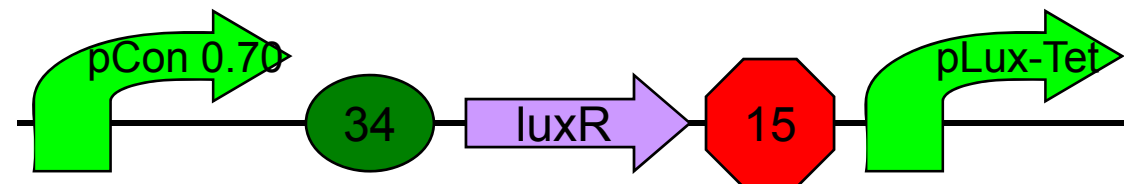
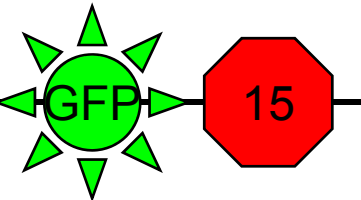
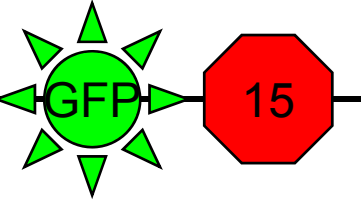
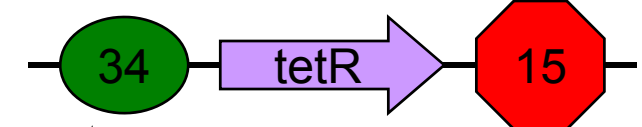

K176029 in pSB1A3
Sequence ?

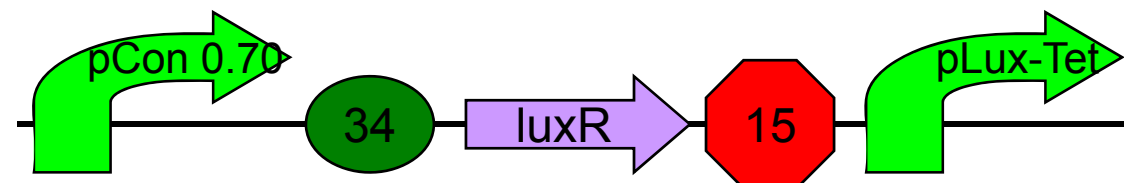

K176030 in pSB1A3
Sequence ?

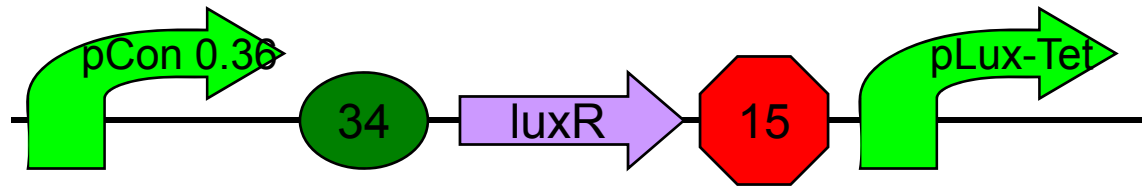

K176125 in pSB1A3
Waiting

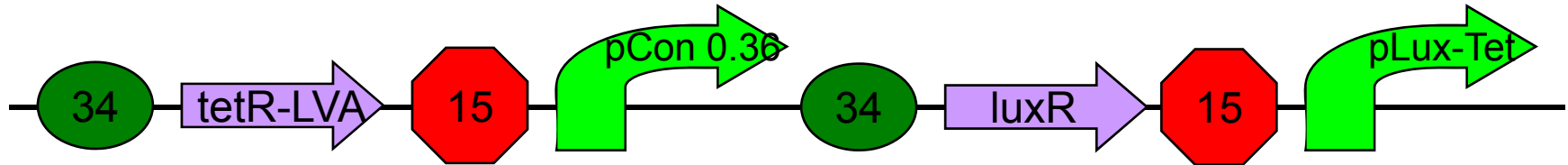

K176133 in pSB1A3
Waiting

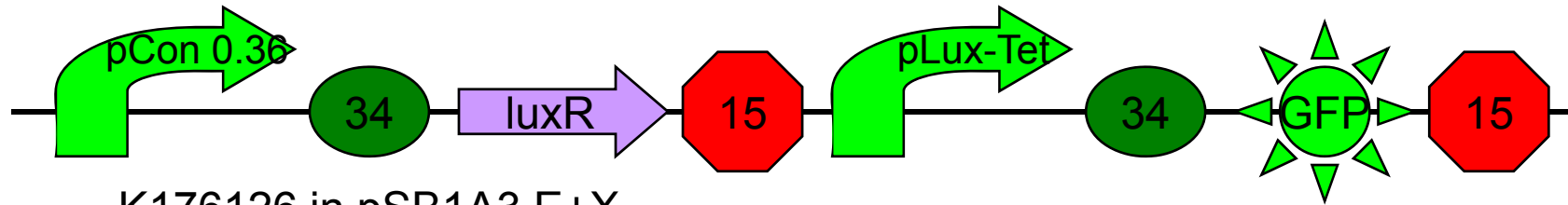

K176126 in pSB1A3 E+X
Length OK

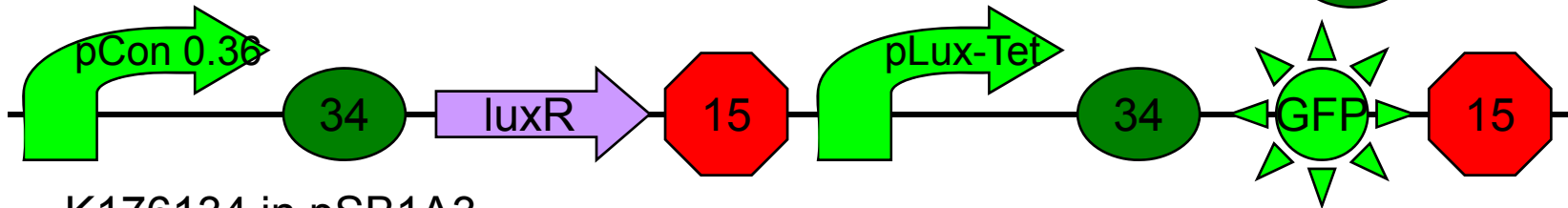

K176134 in pSB1A3
Sequencing

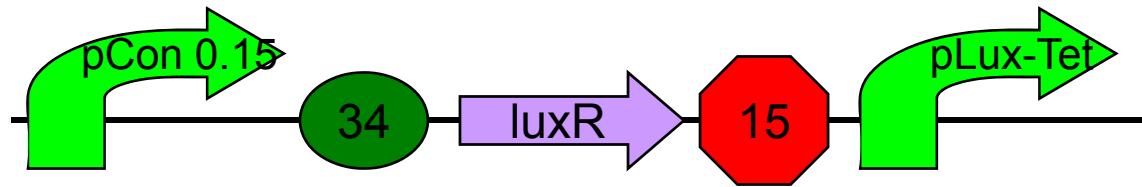

K176127 in pSB1A3
Digestion

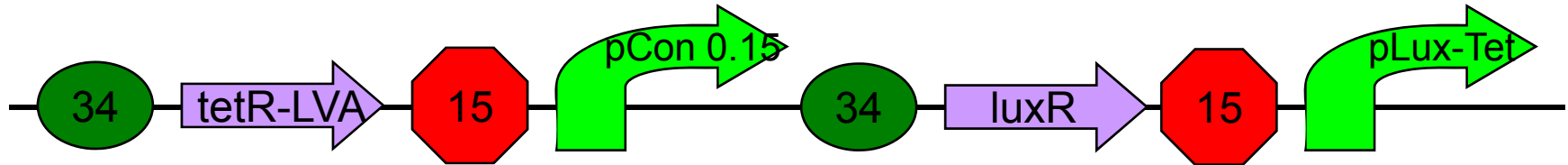

K176171 in pSB1A3
Waiting

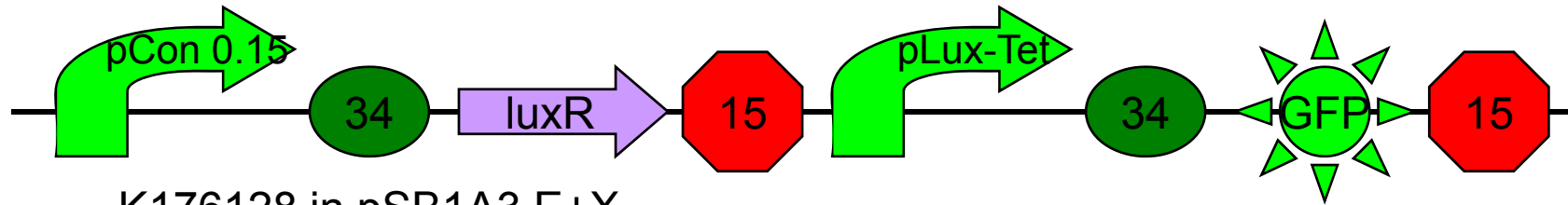

K176128 in pSB1A3 E+X
Length OK

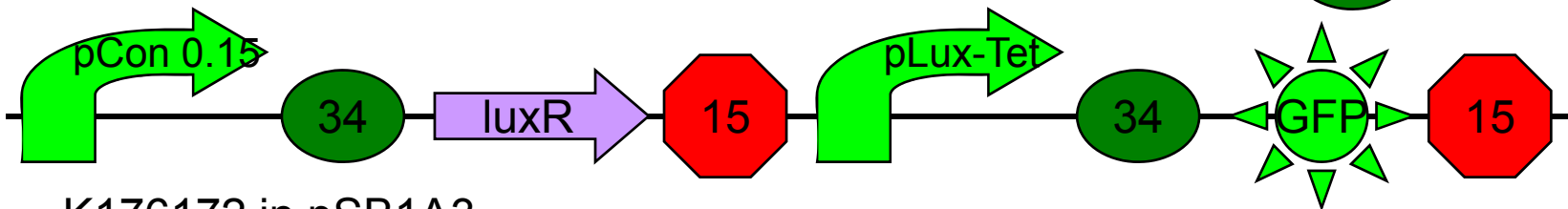

K176172 in pSB1A3
Sequencing

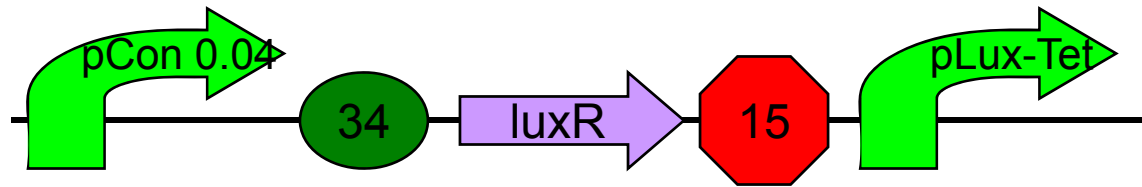

K176129 in pSB1A3
Digestion

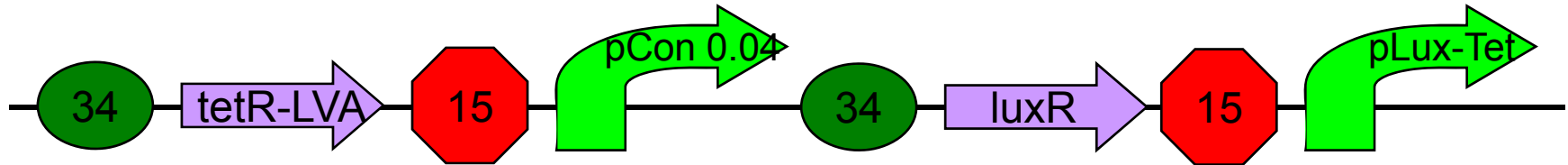

K176173 in pSB1A3
Waiting

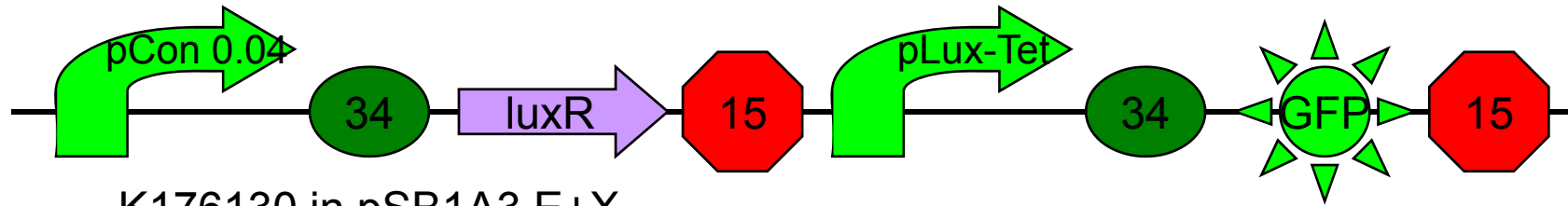

K176130 in pSB1A3 E+X
Length OK

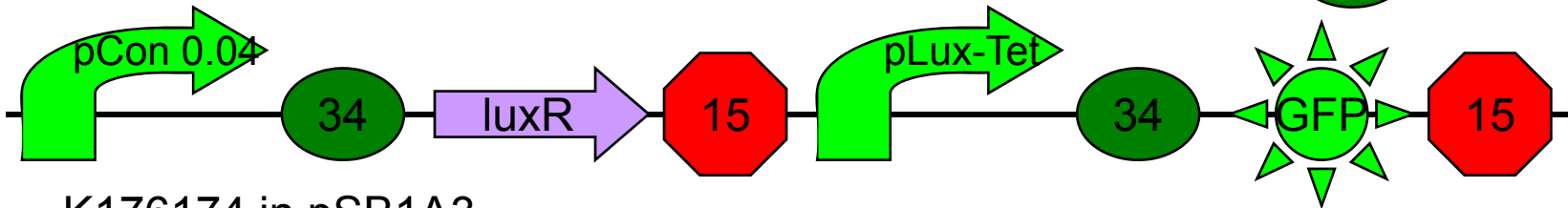

K176174 in pSB1A3
Sequencing

13

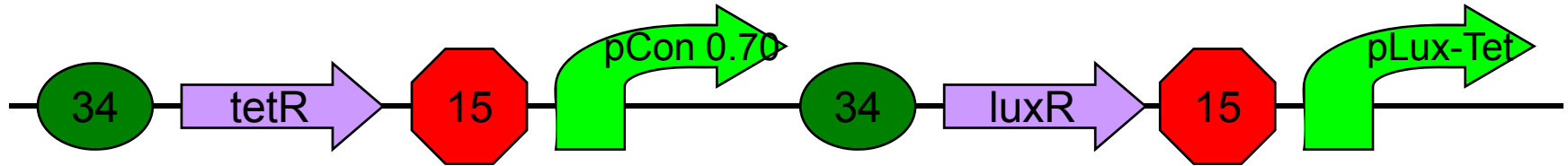

K176031 X+P
Length OK

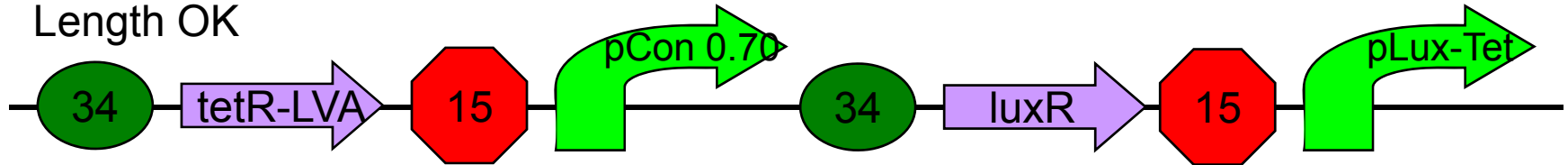

K176032 X+P
Length OK

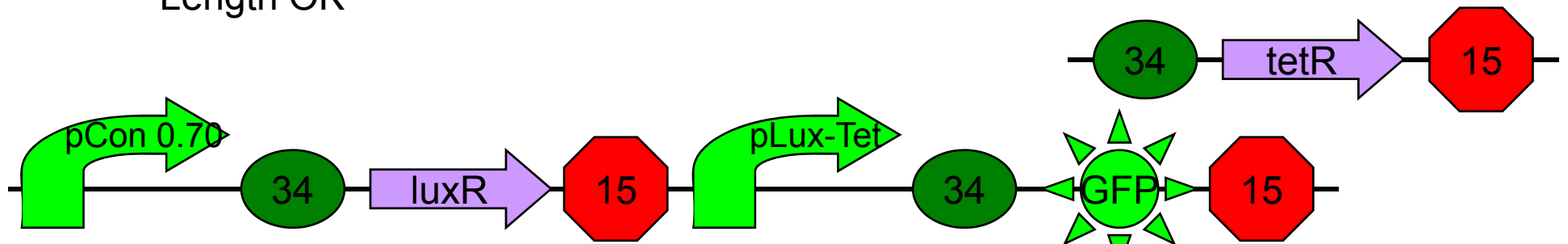

K176029 X+P
Length OK

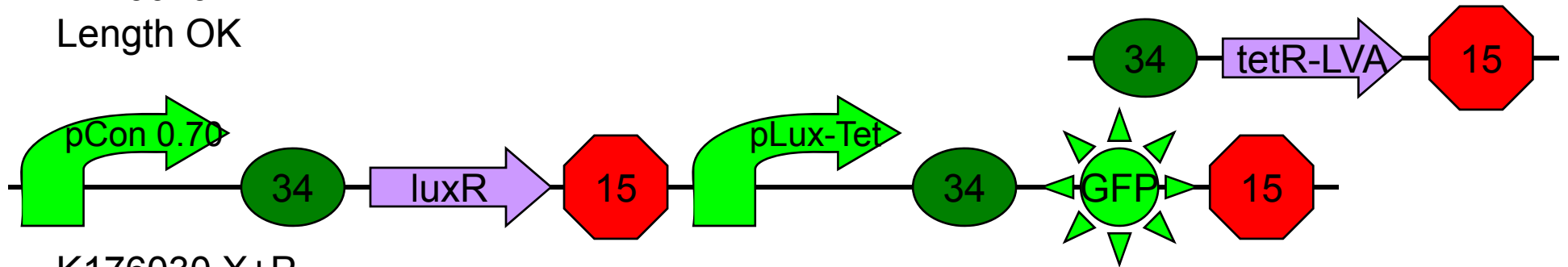

K176030 X+P
Length OK

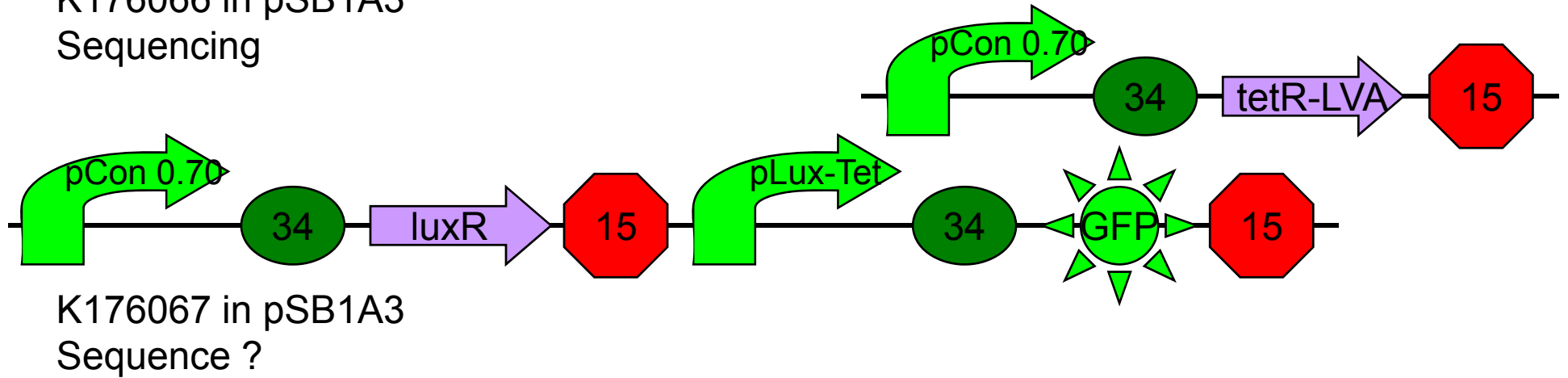
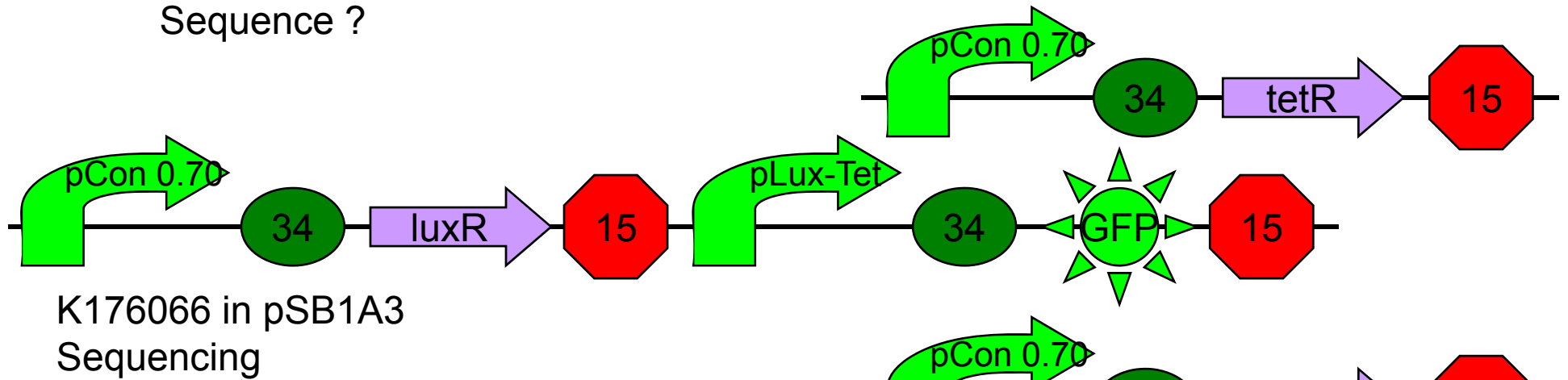
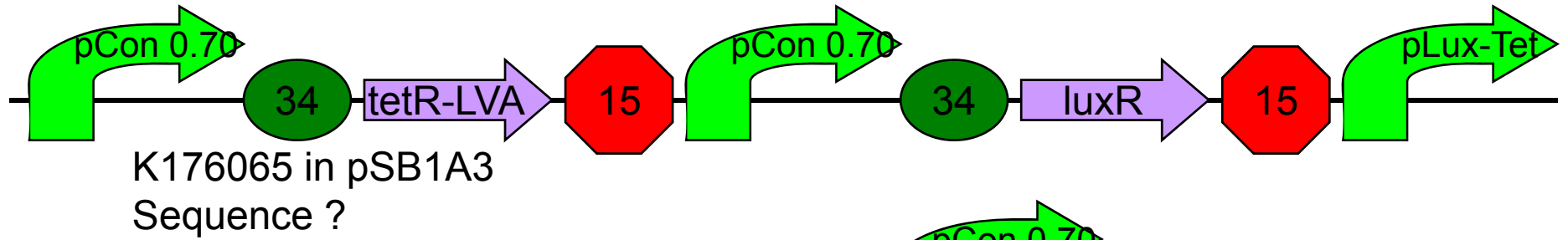
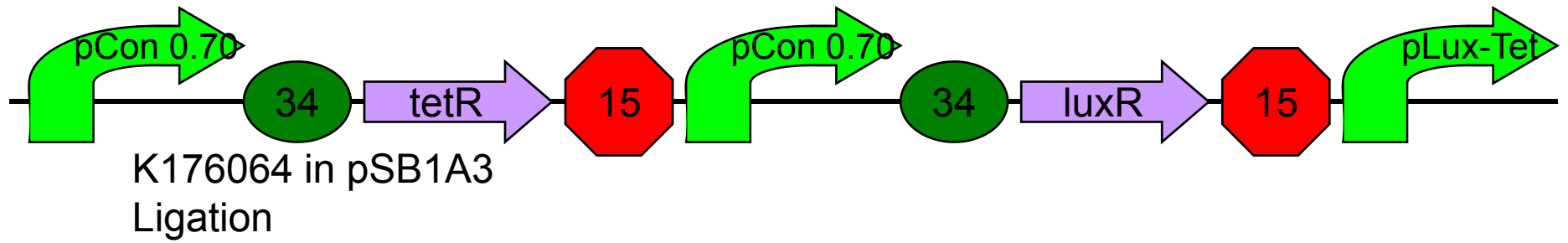

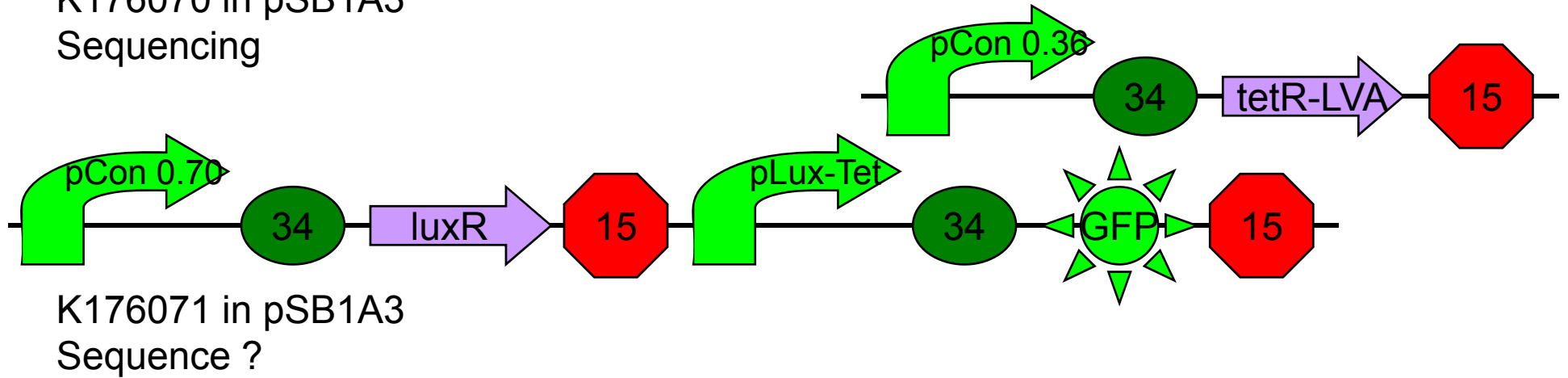
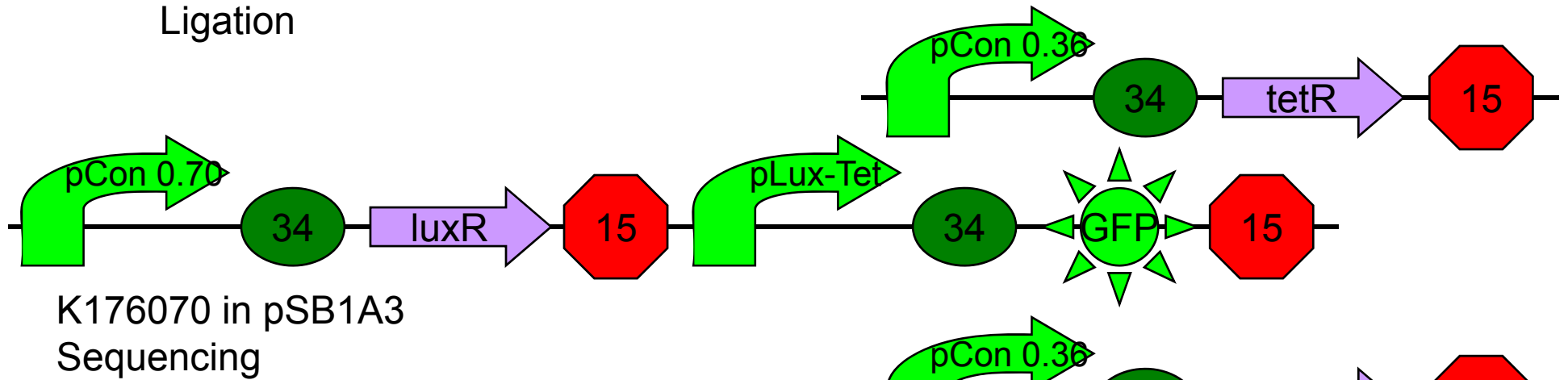
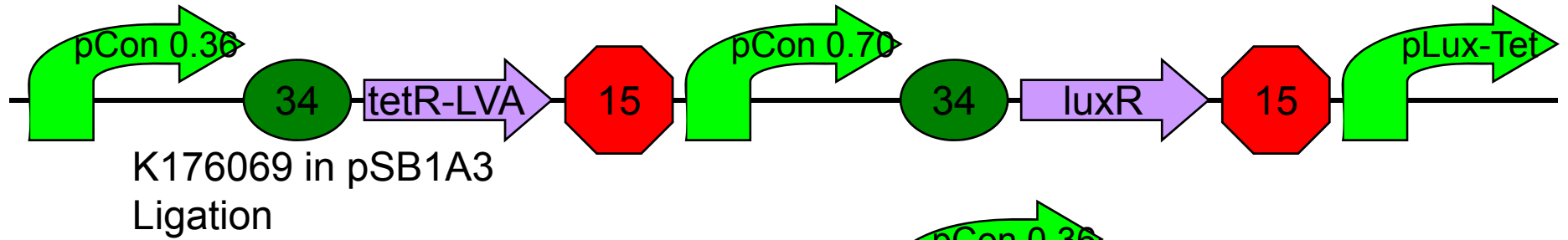
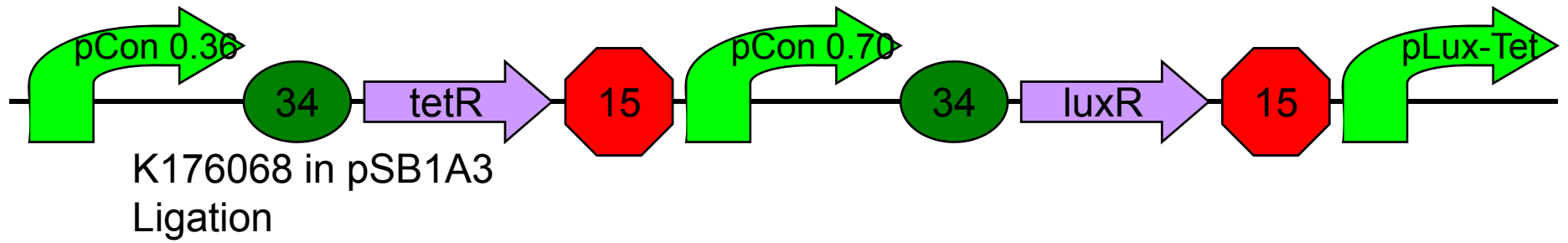

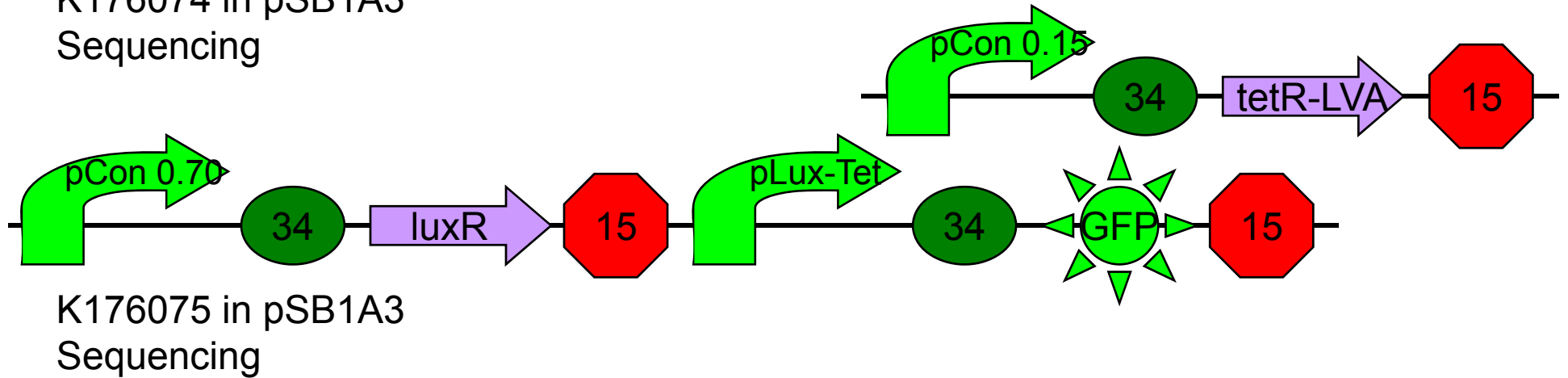
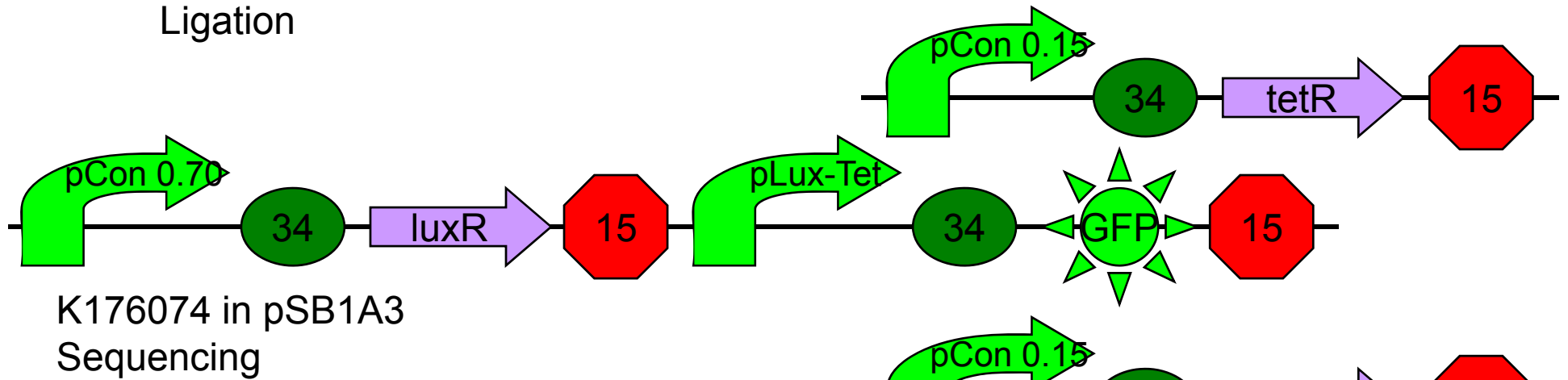
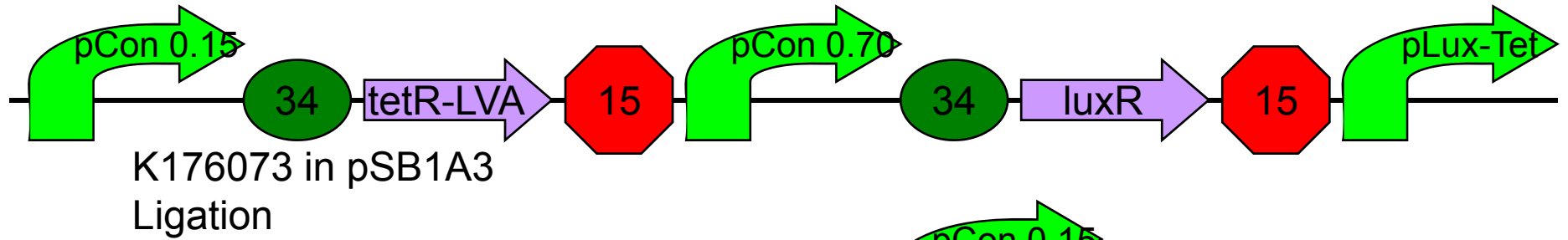
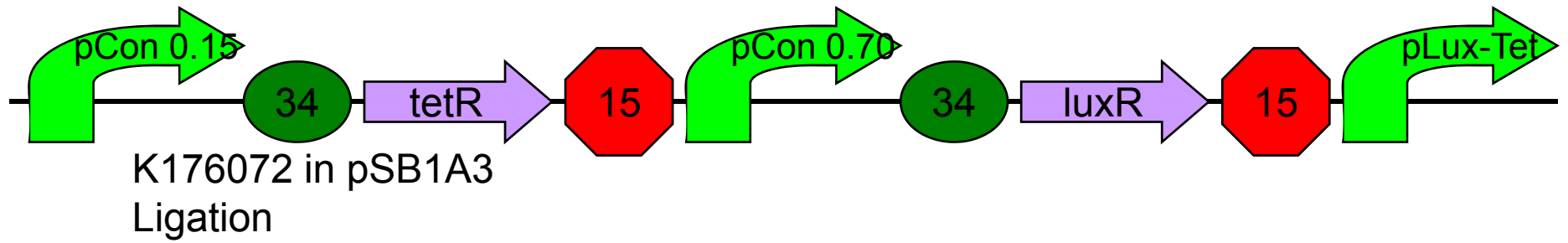

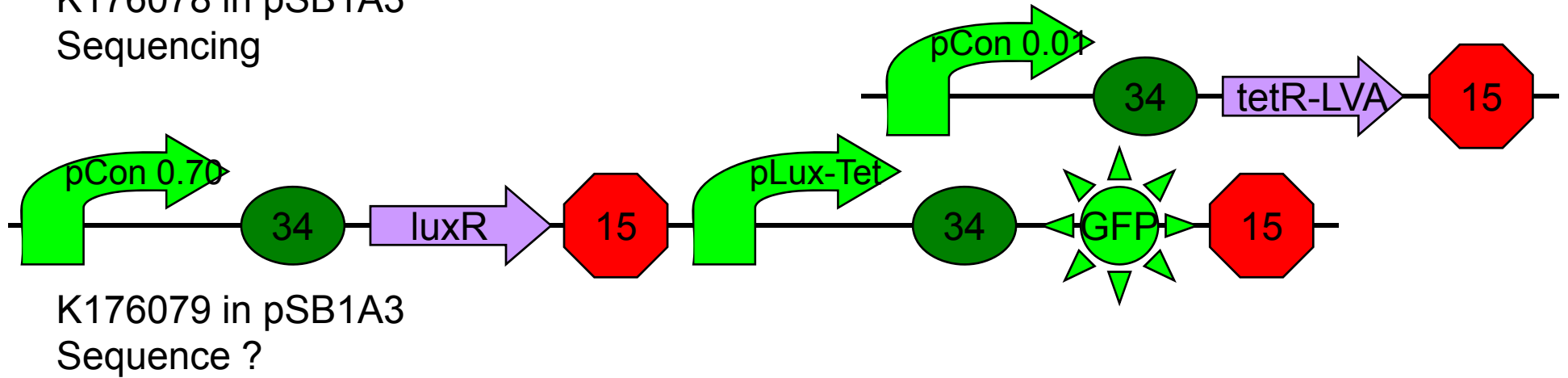
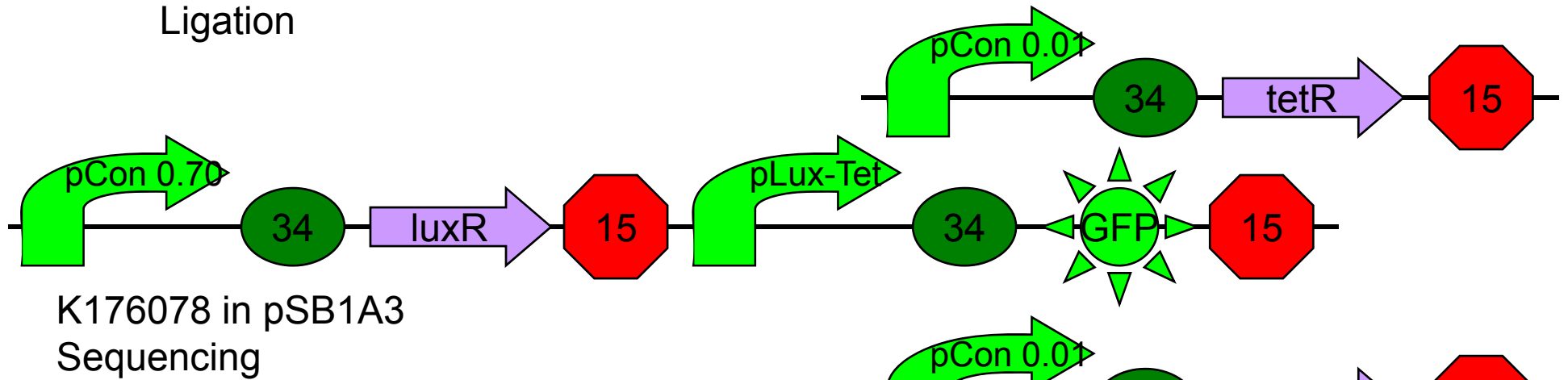
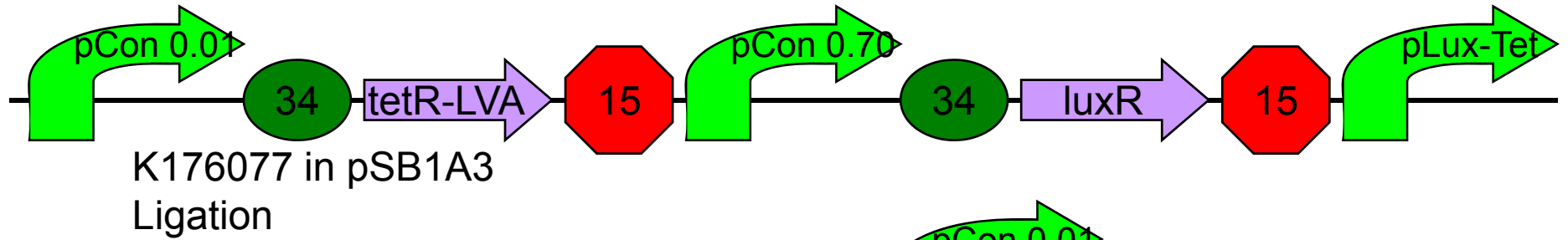
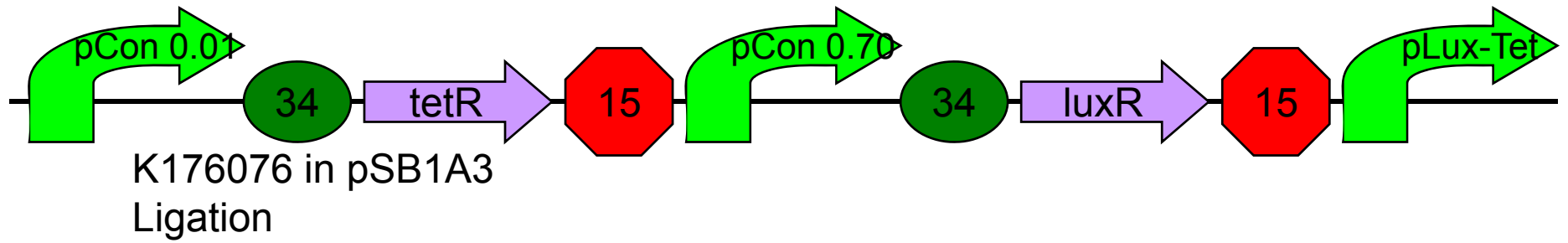

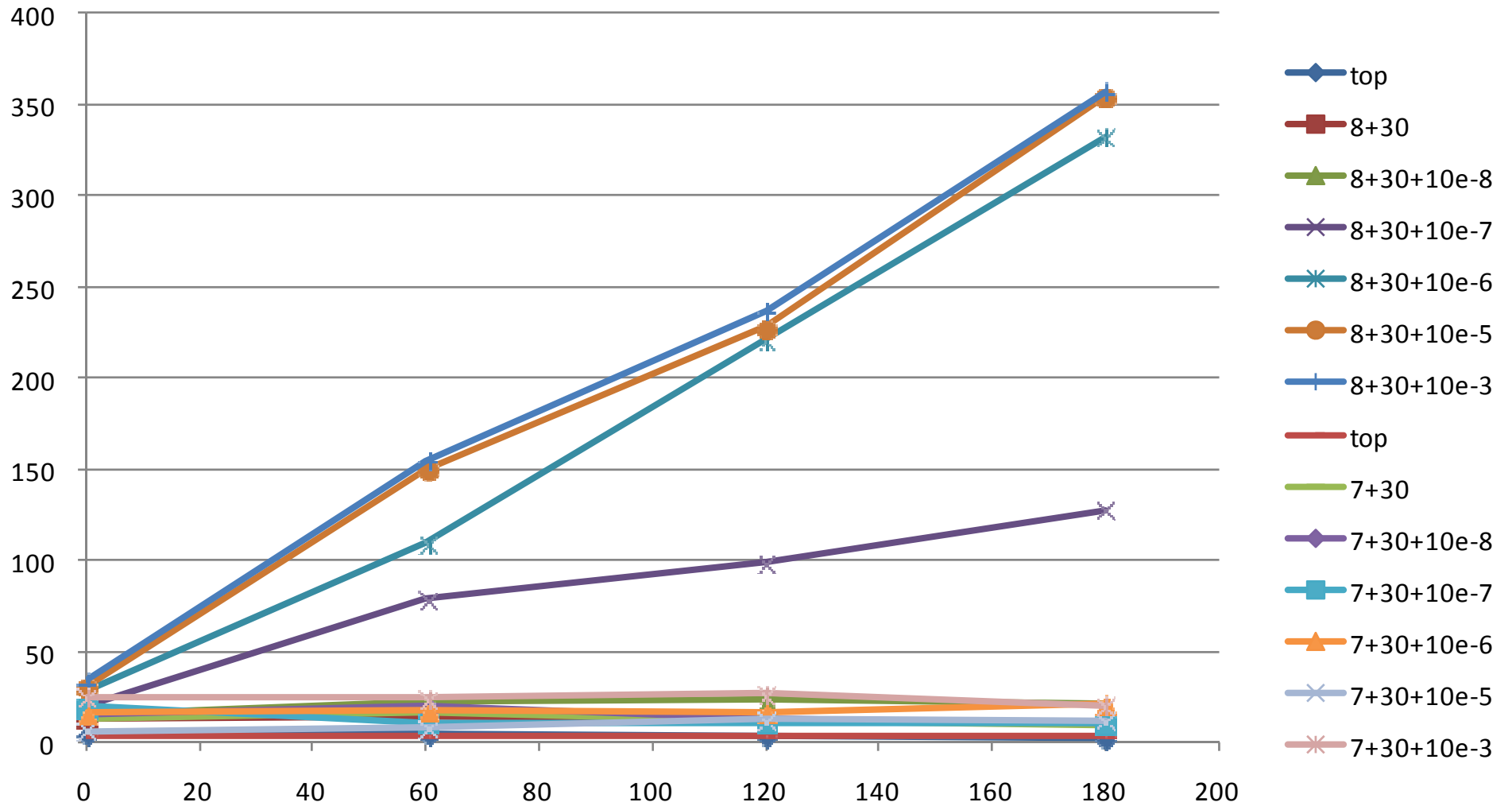

K176067 (7+30)

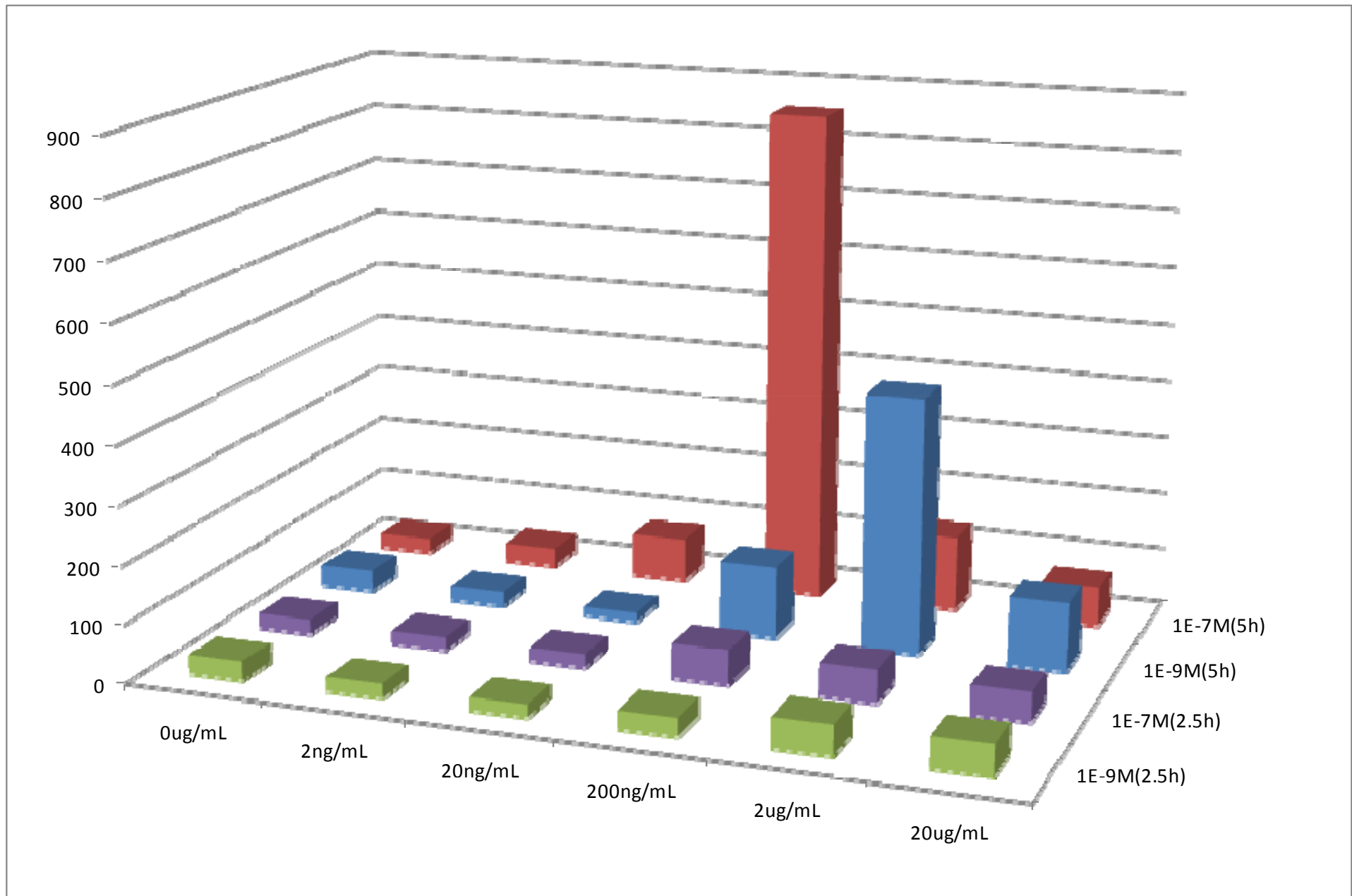

K176070 (9+29)

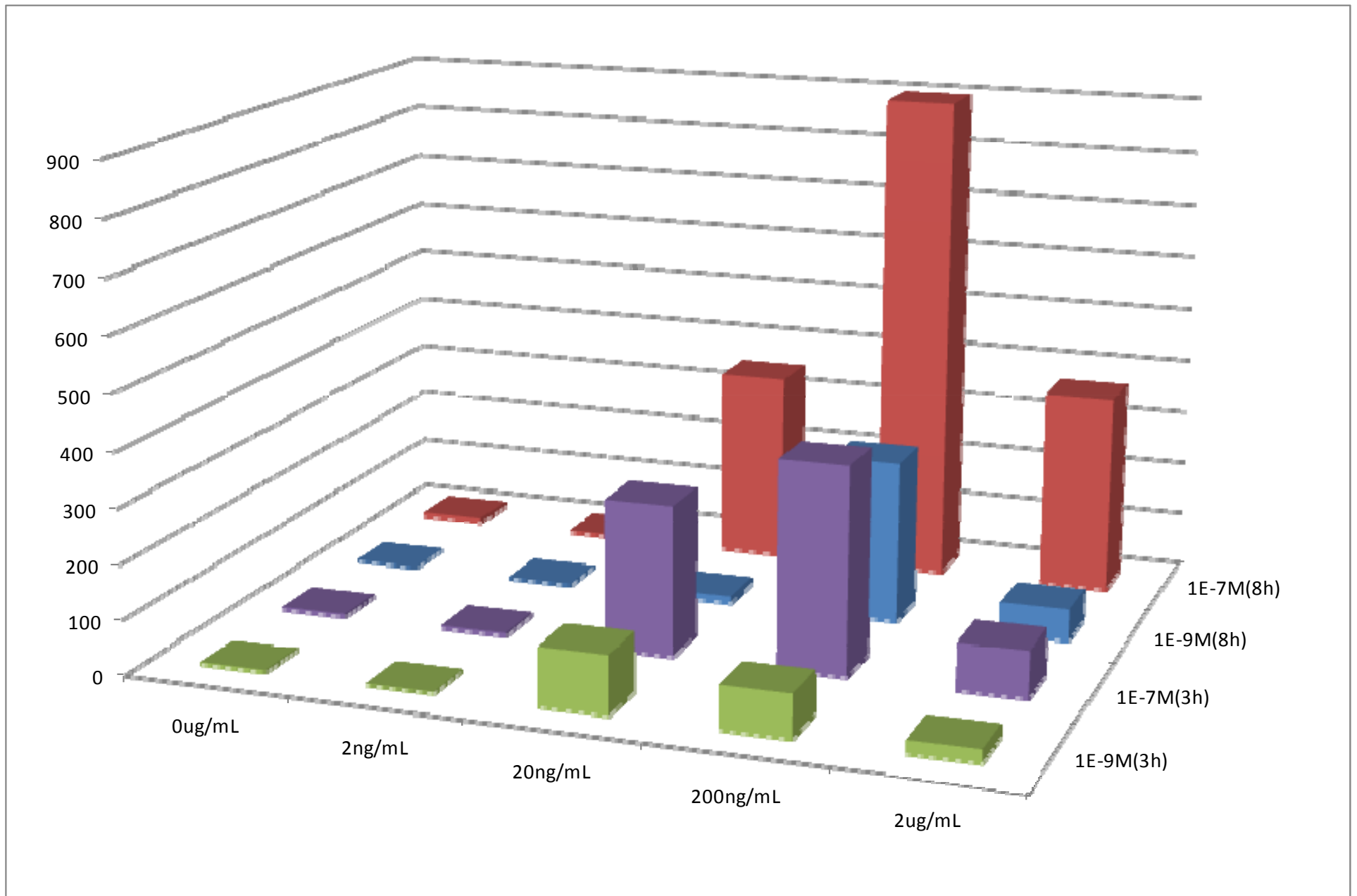

K176071 (9+30)

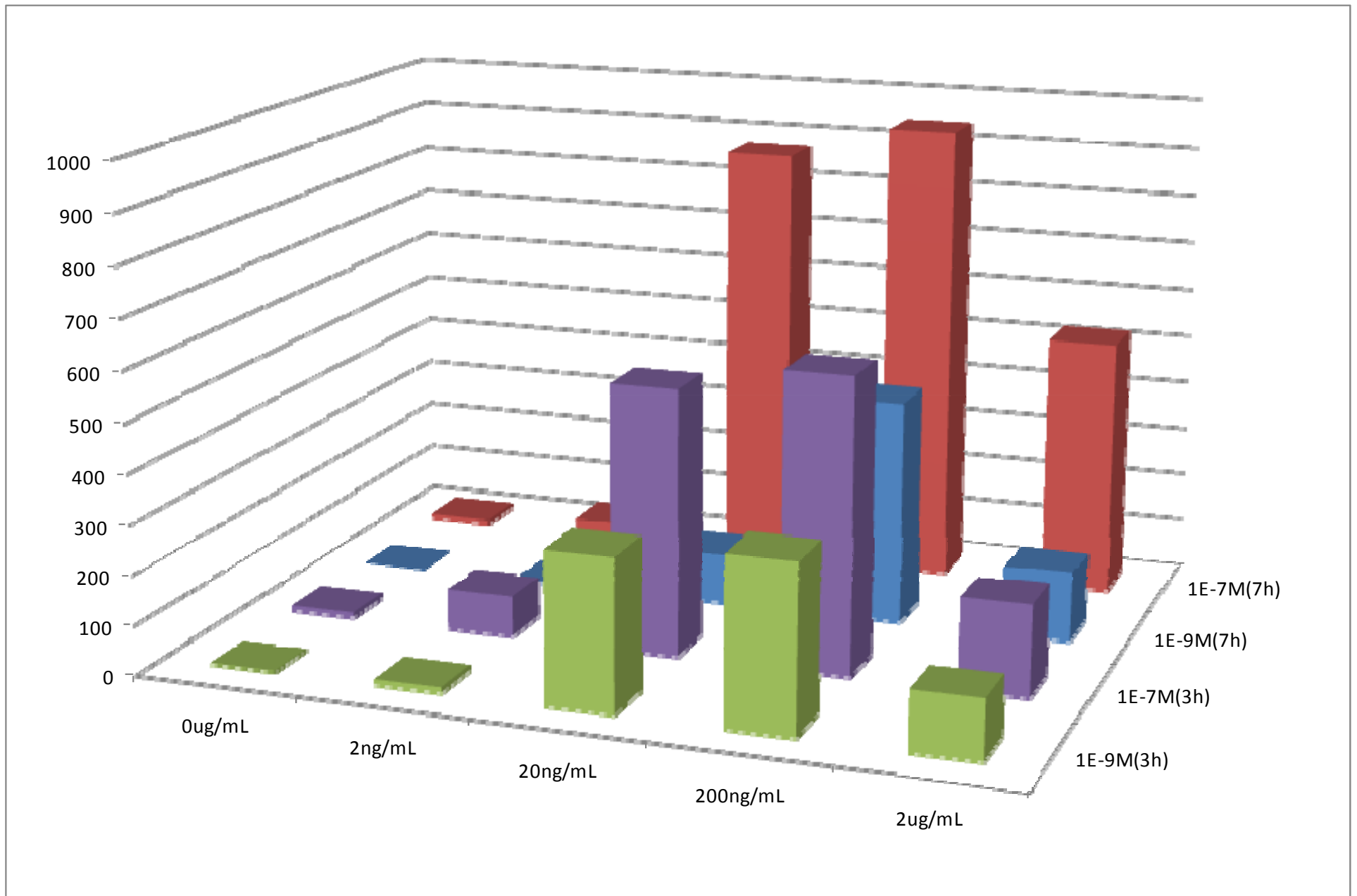

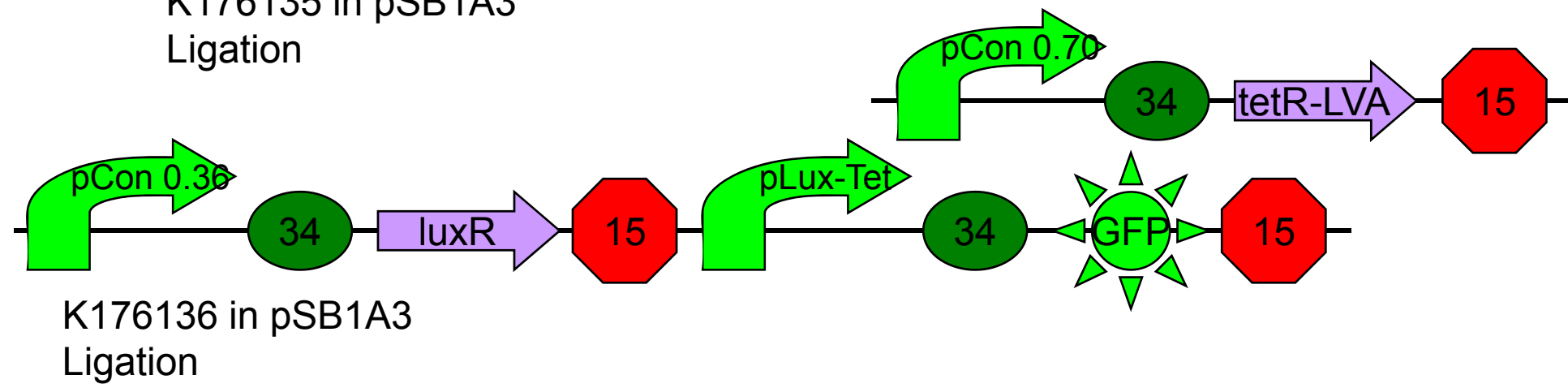
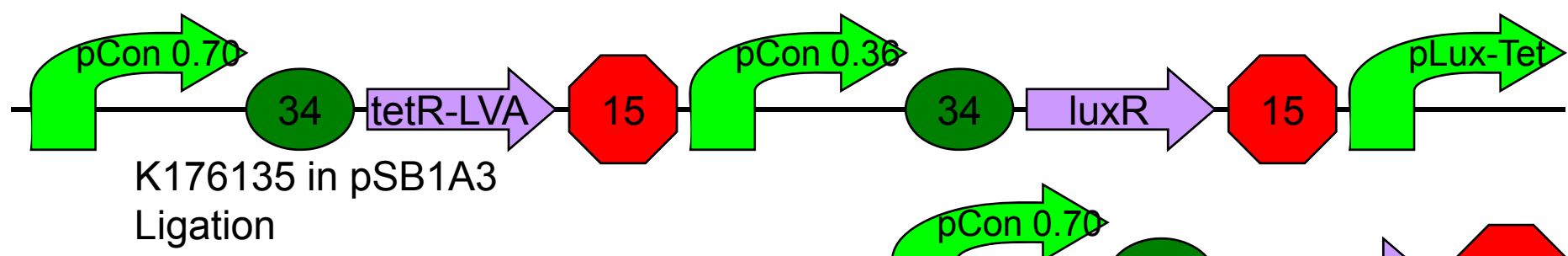
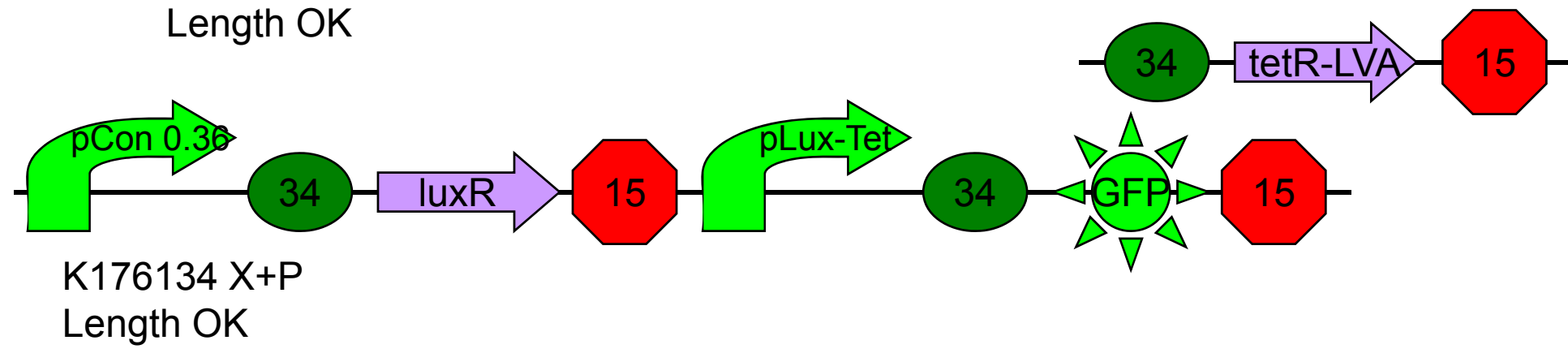
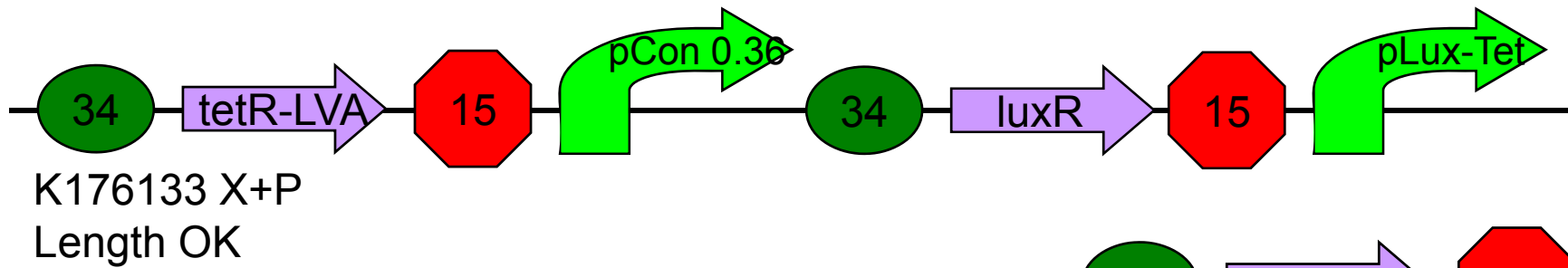

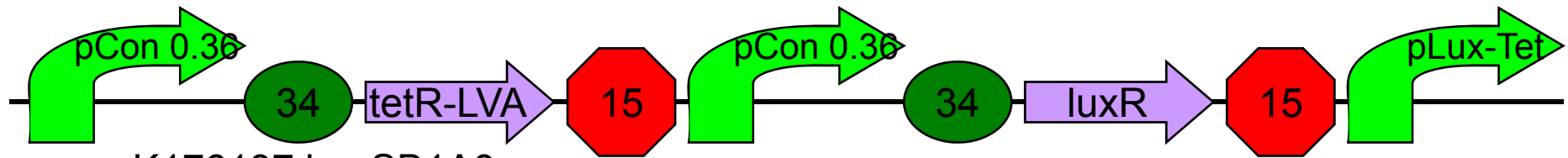

K176137 in pSB1A3
Ligation

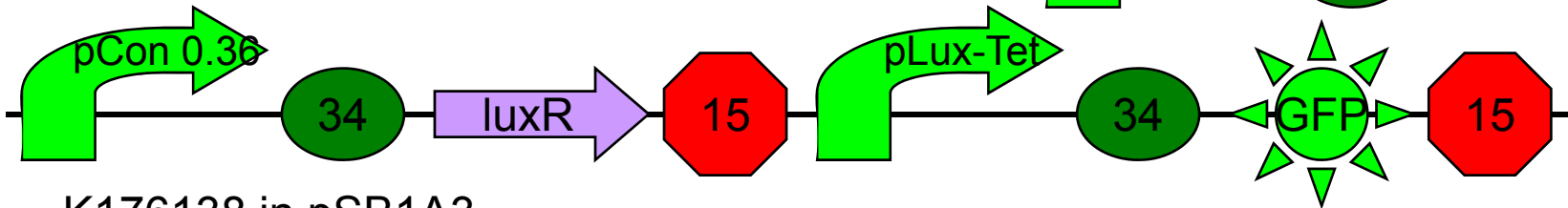
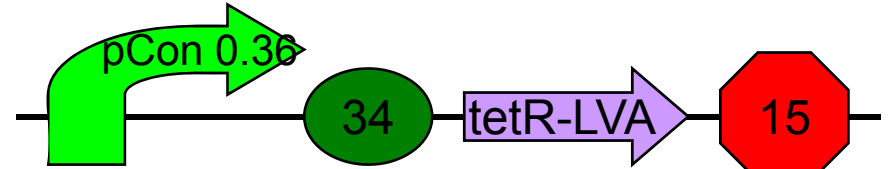

K176138 in pSB1A3
Sequencing

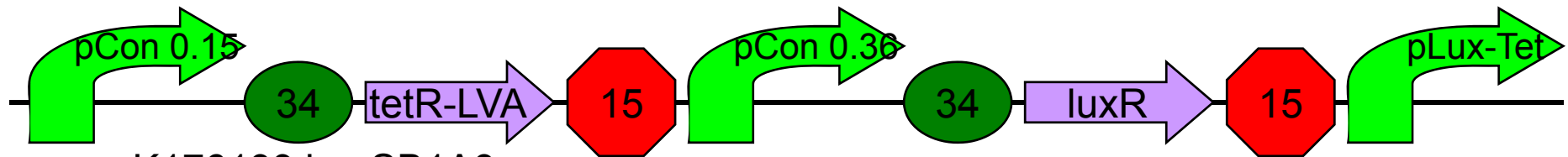

K176139 in pSB1A3
Ligation

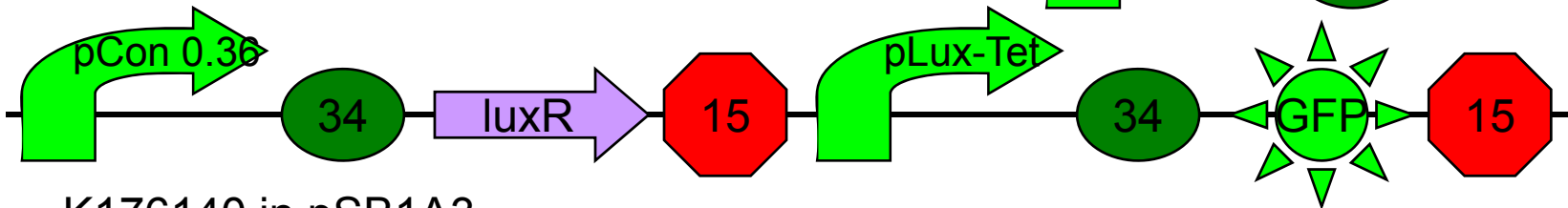
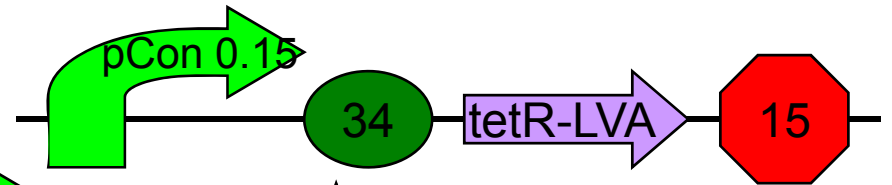

K176140 in pSB1A3
Sequencing

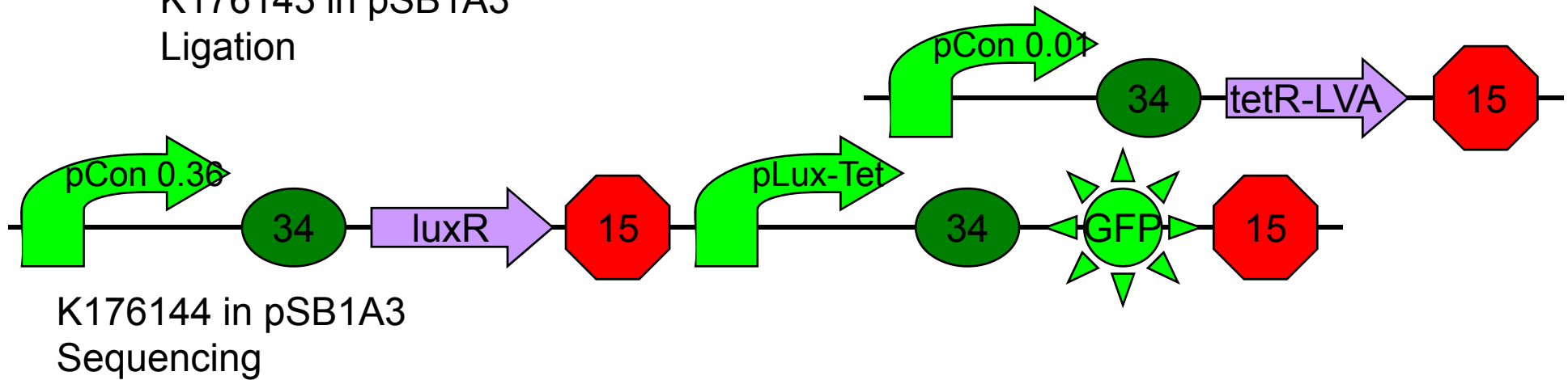
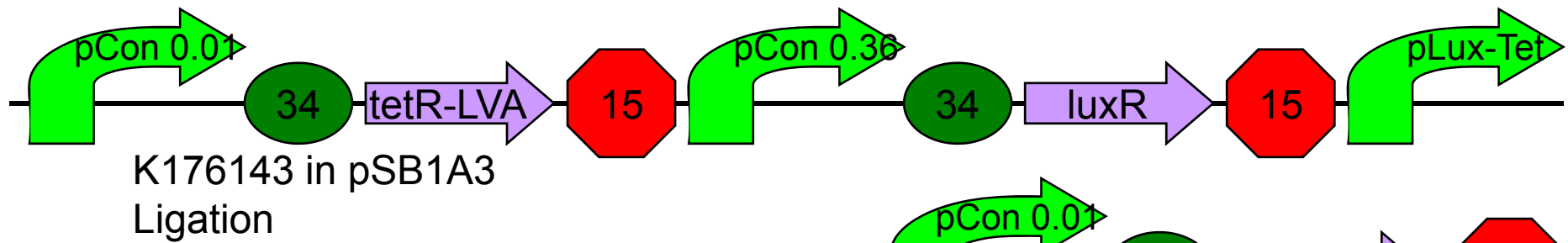
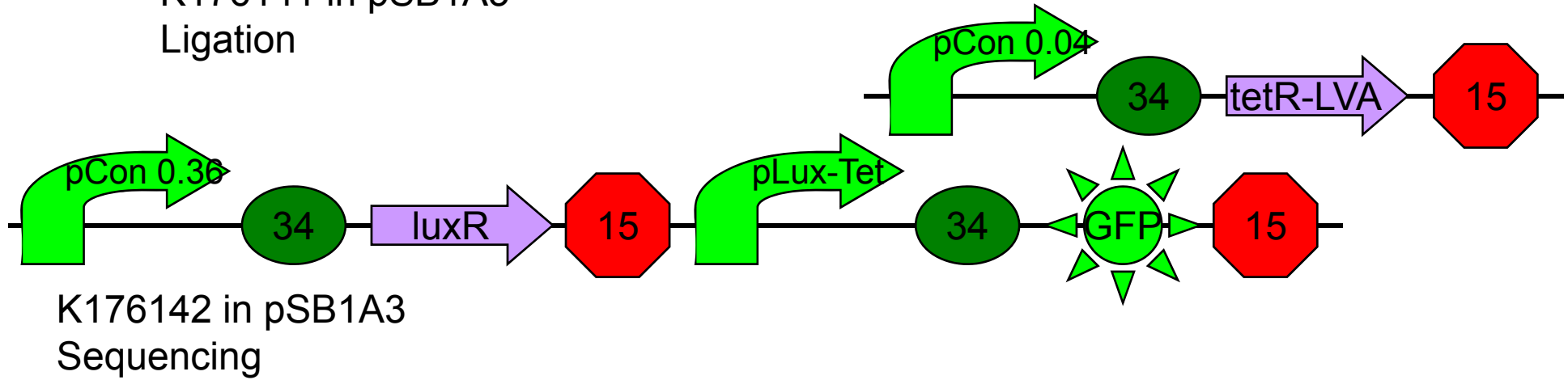
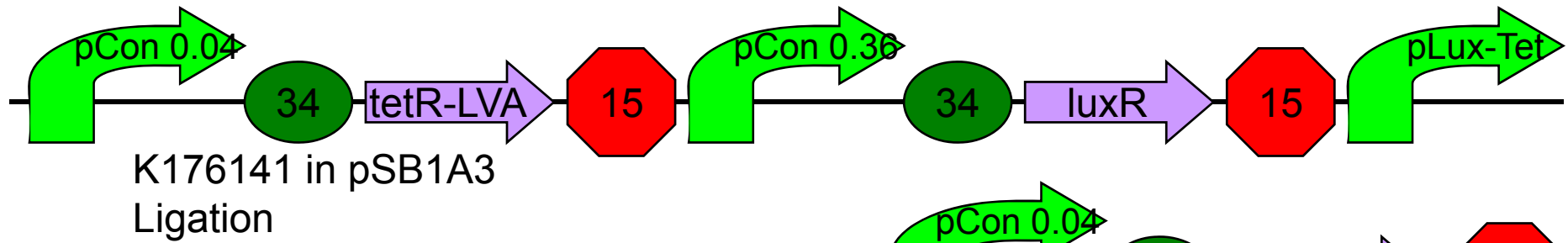

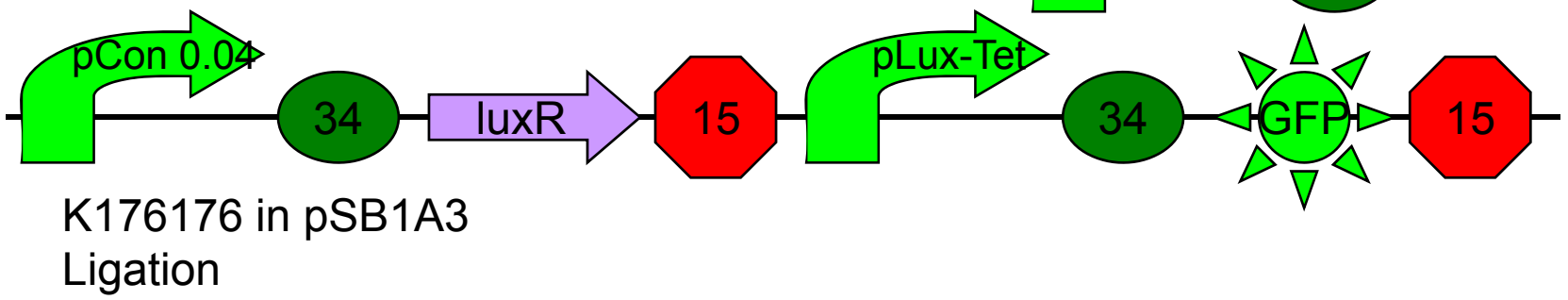
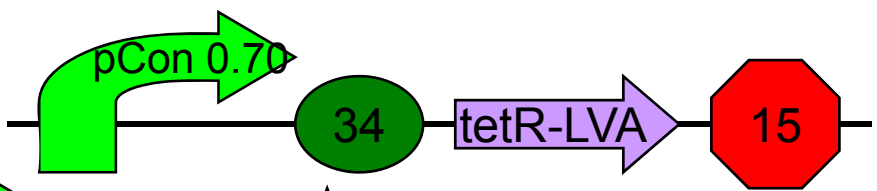
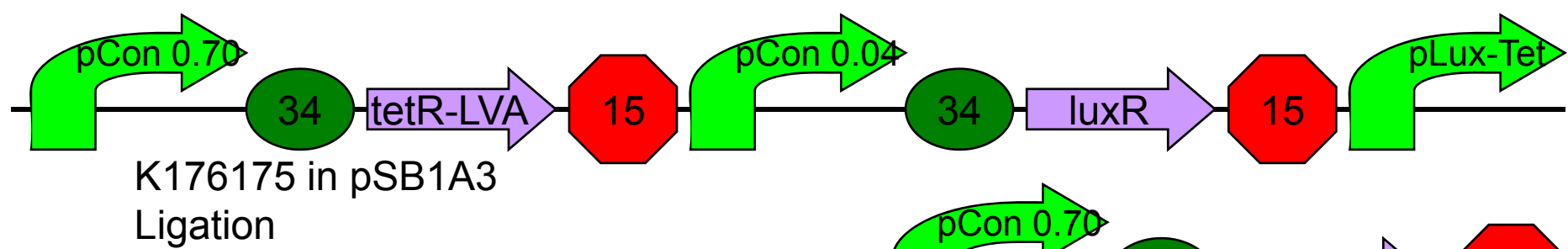
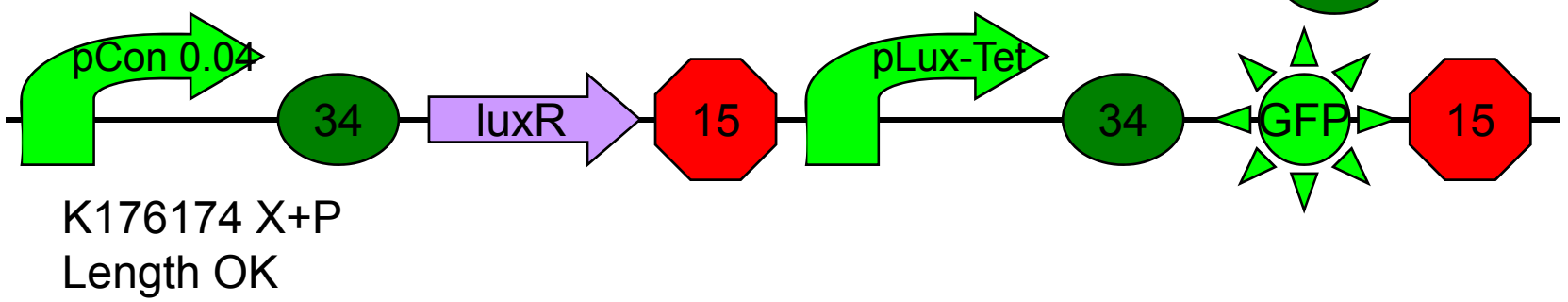
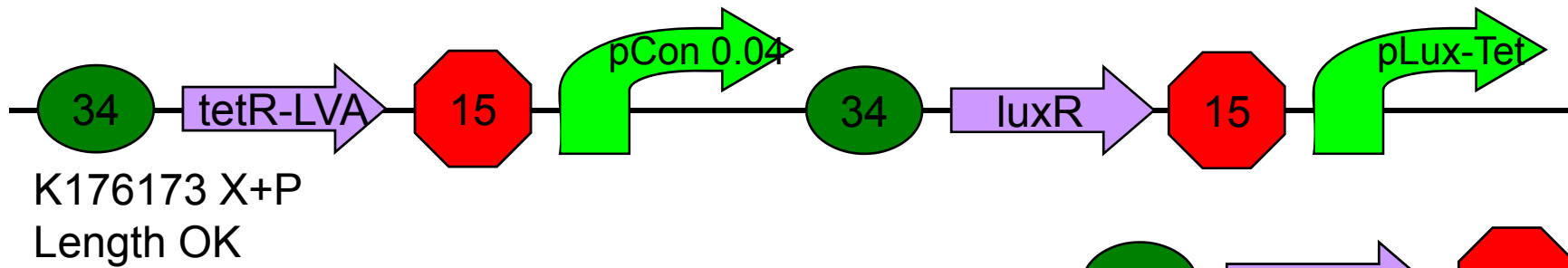

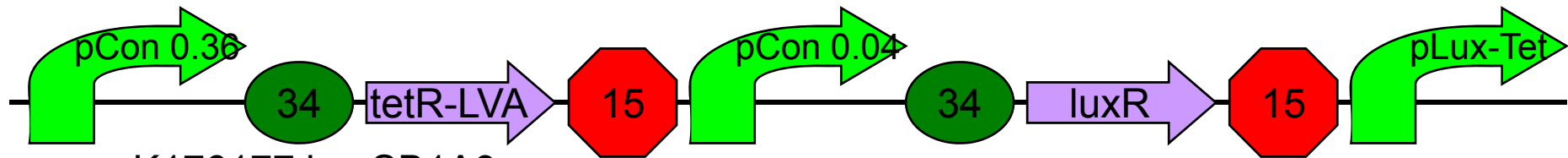

K176177 in pSB1A3
Ligation

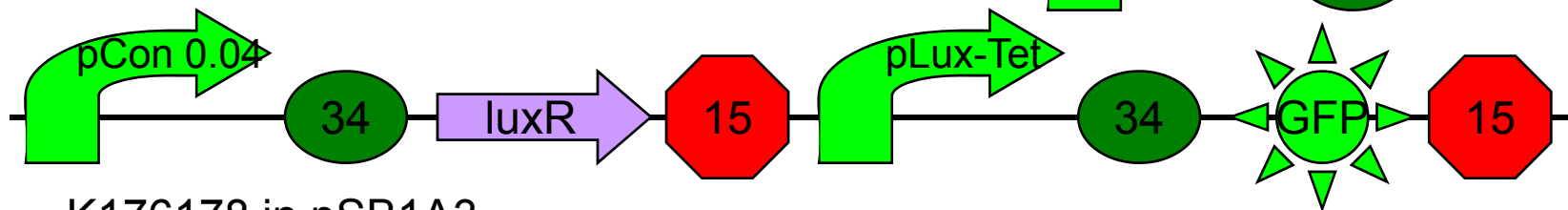
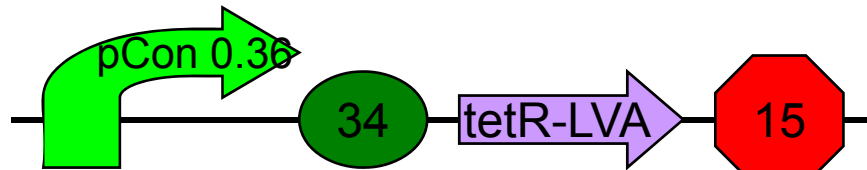

K176178 in pSB1A3
Sequencing

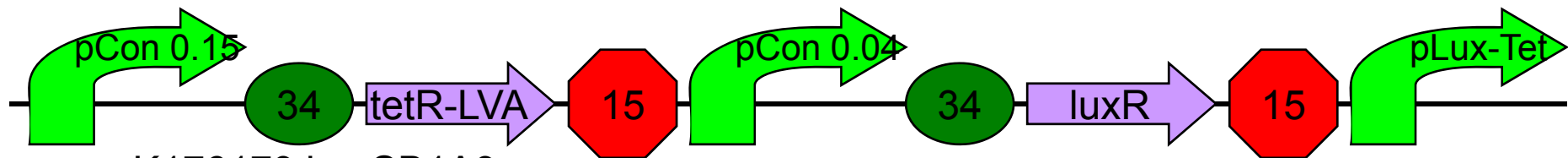

K176179 in pSB1A3
Ligation

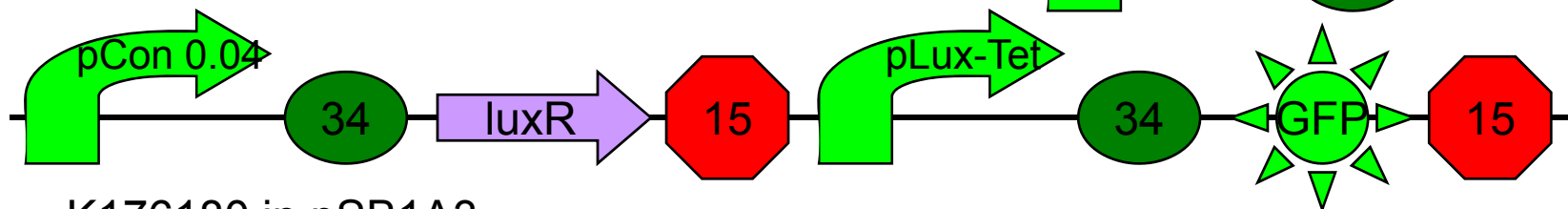
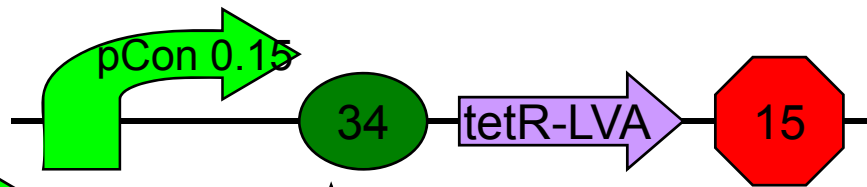

K176180 in pSB1A3
Sequencing

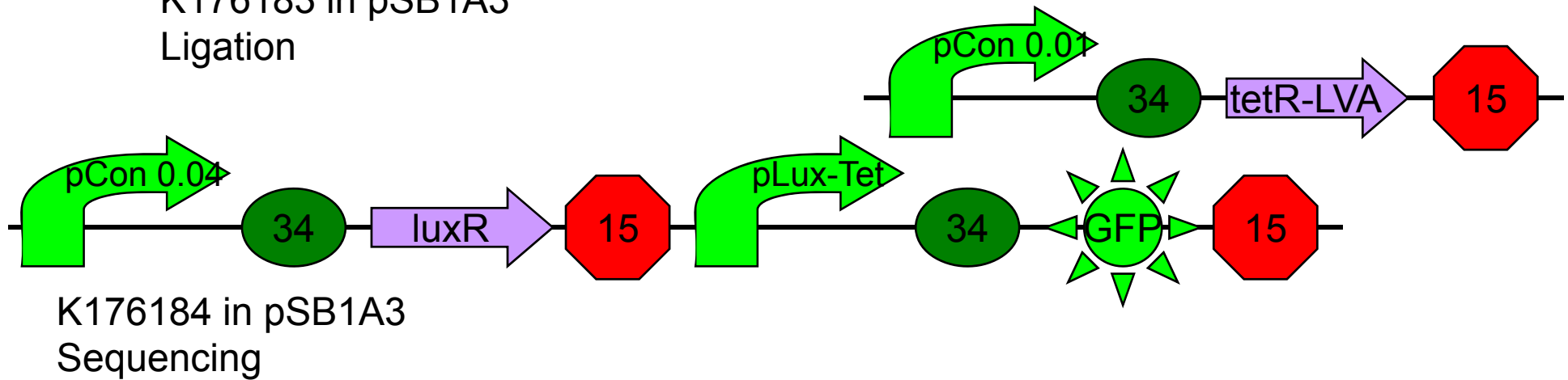
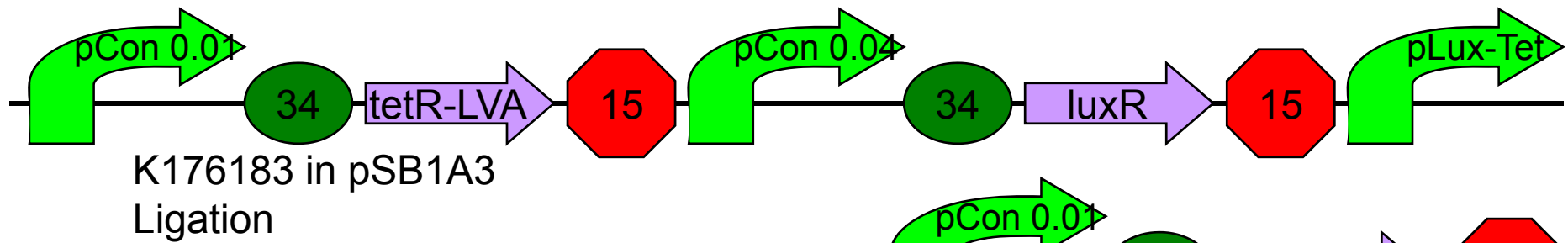
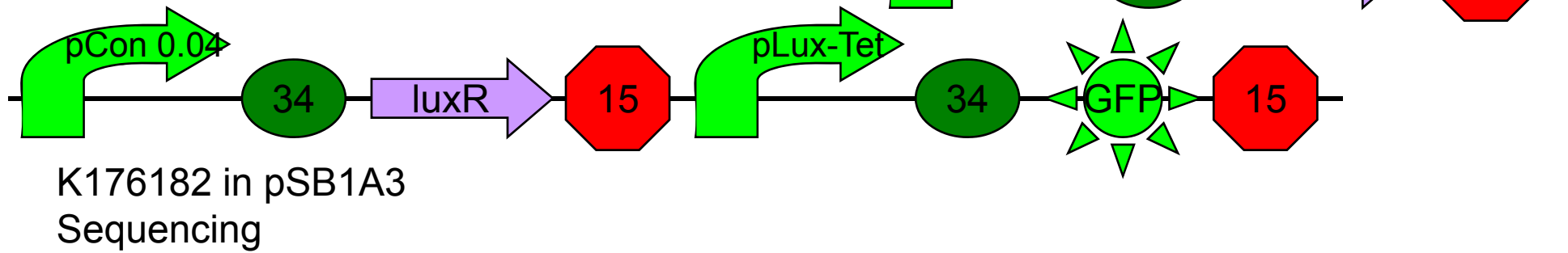
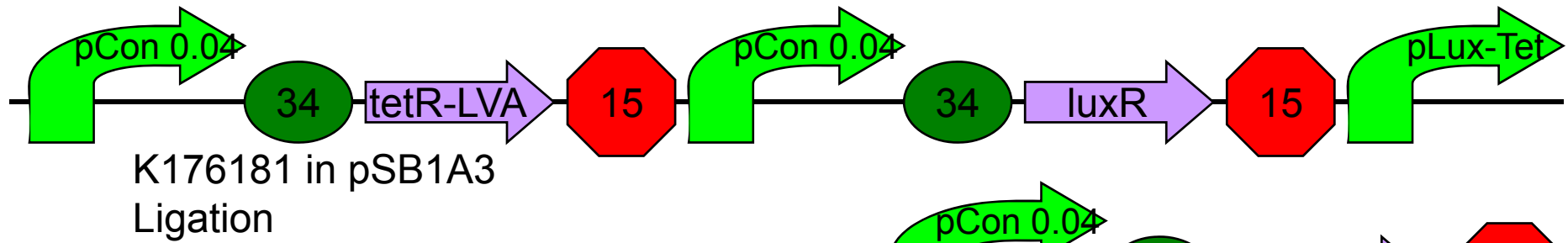

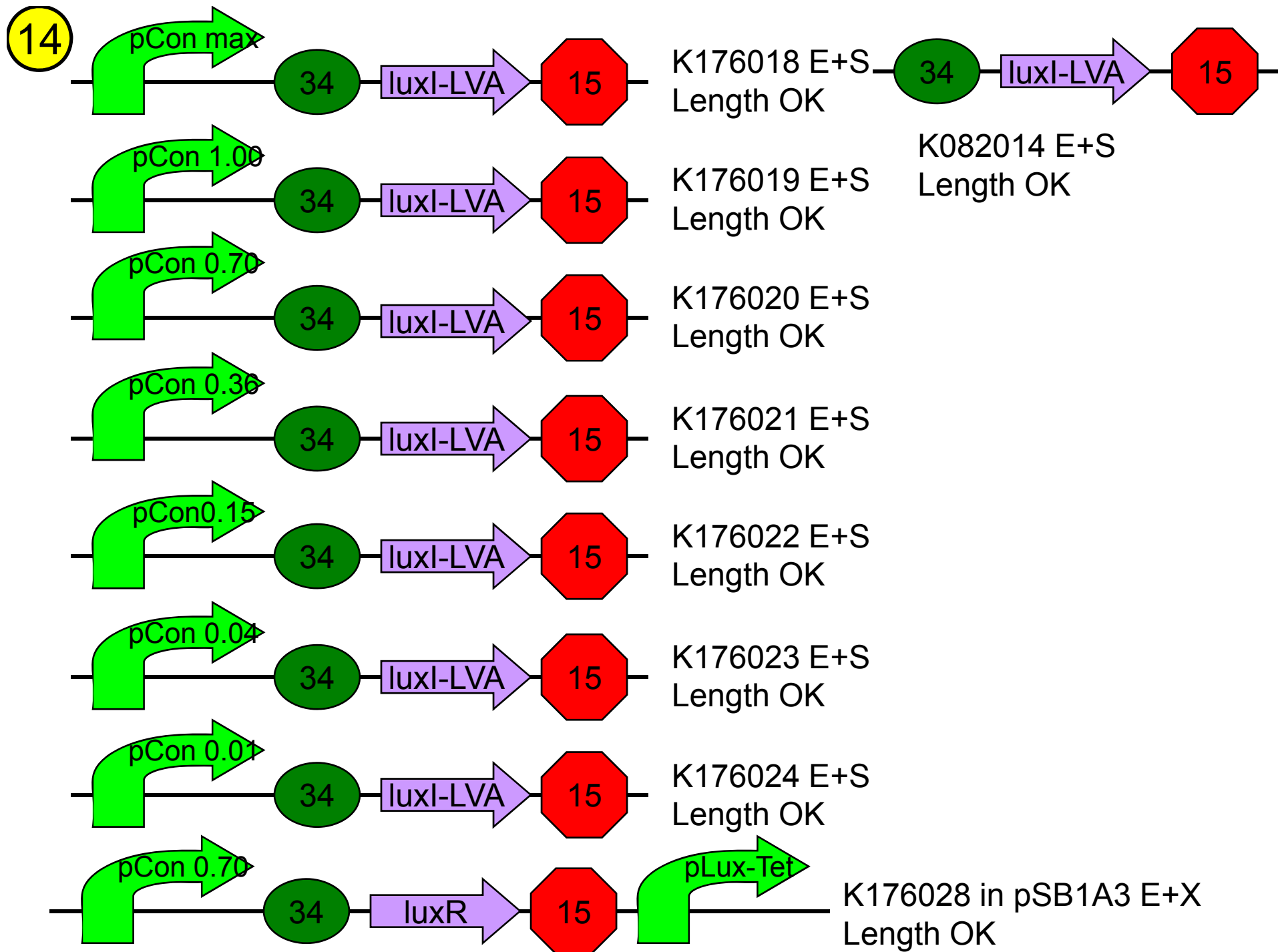

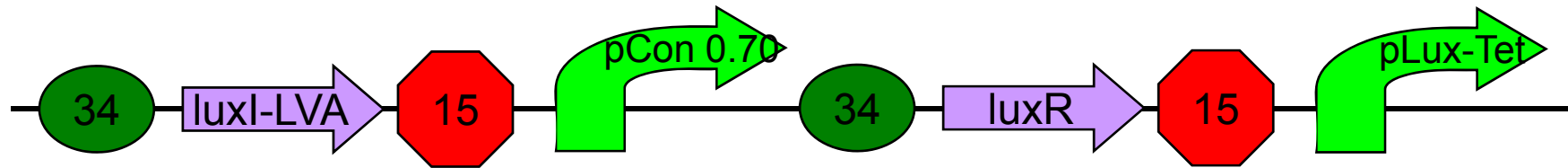

K176080 in pSB1A3
Ligation

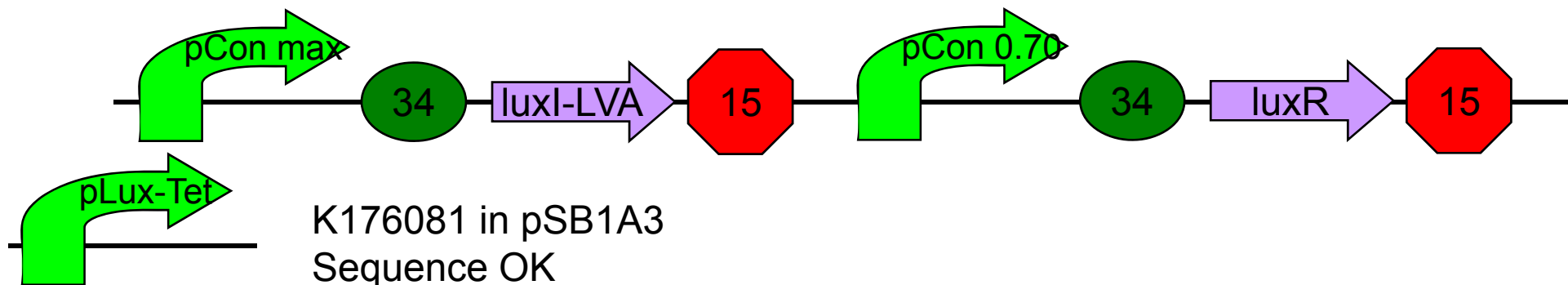

K176081 in pSB1A3
Sequence OK

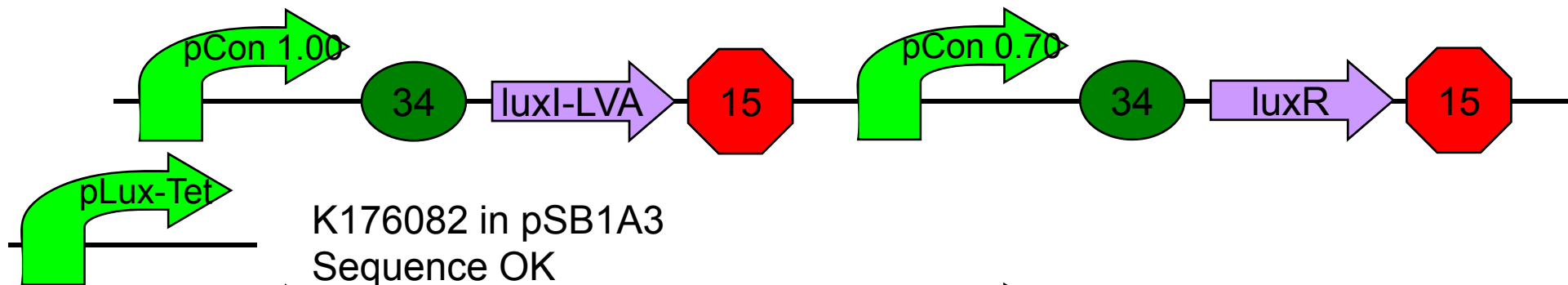

K176082 in pSB1A3
Sequence OK

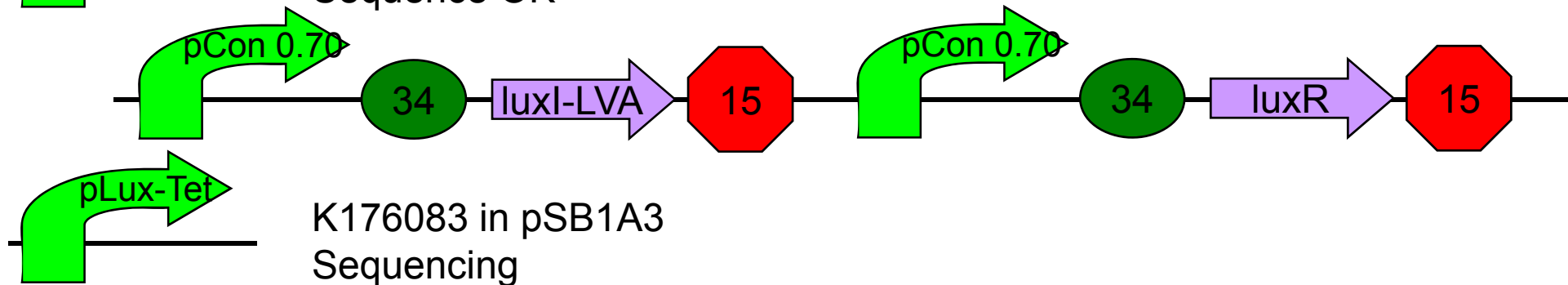

K176083 in pSB1A3
Sequencing

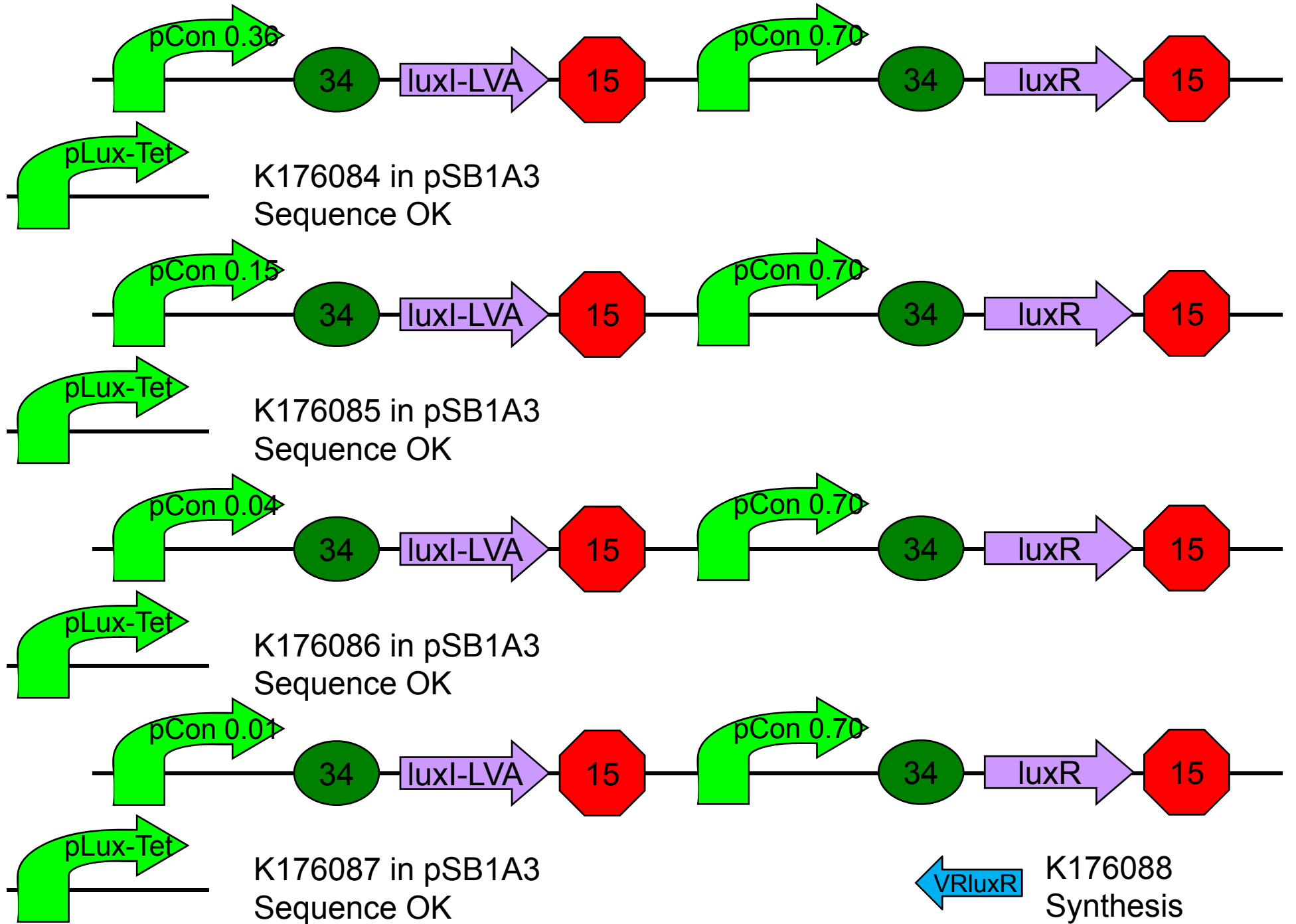

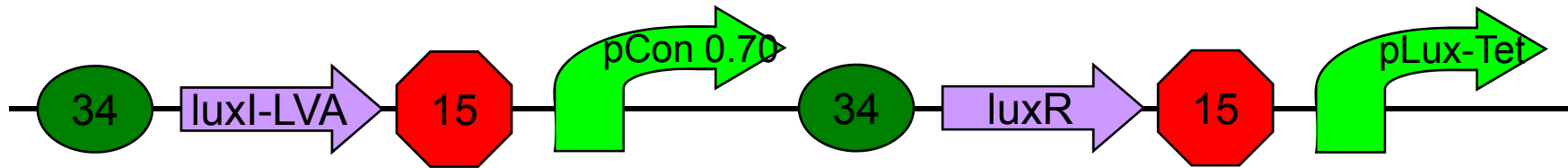

K176080 in pSB1A3 S+P
Waiting

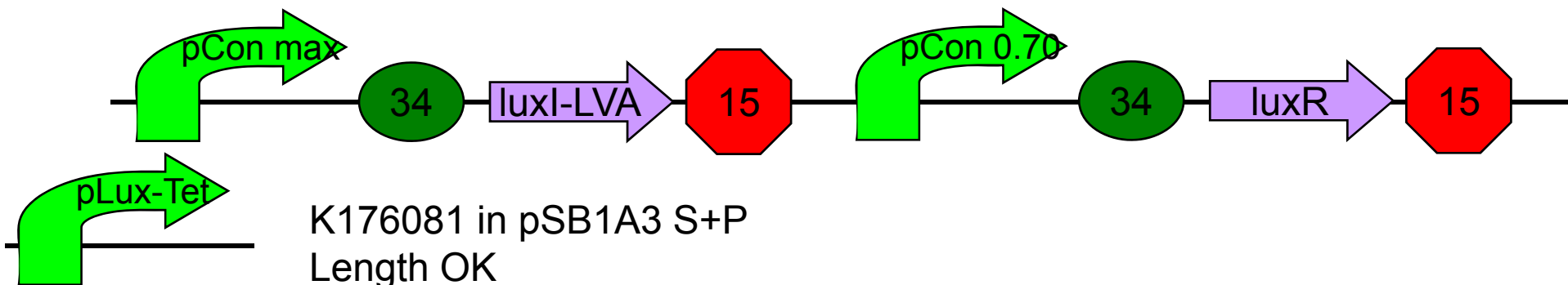

K176081 in pSB1A3 S+P
Length OK

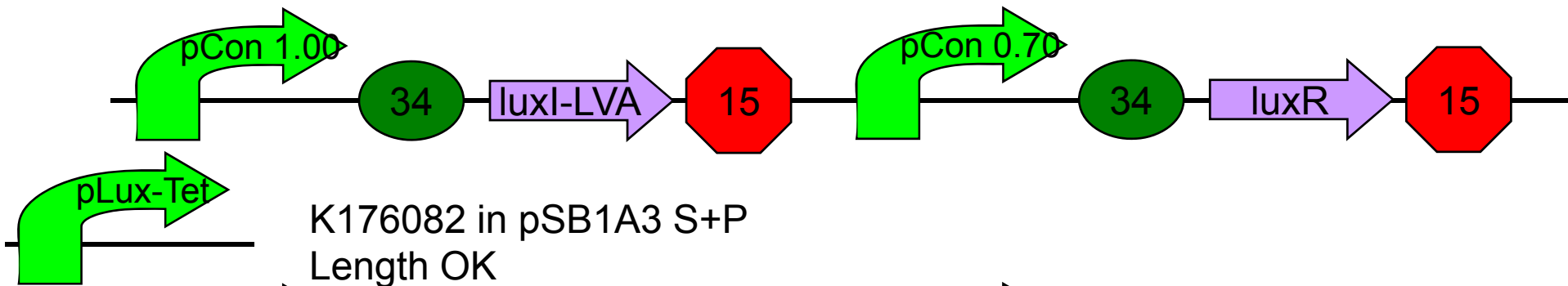

K176082 in pSB1A3 S+P
Length OK

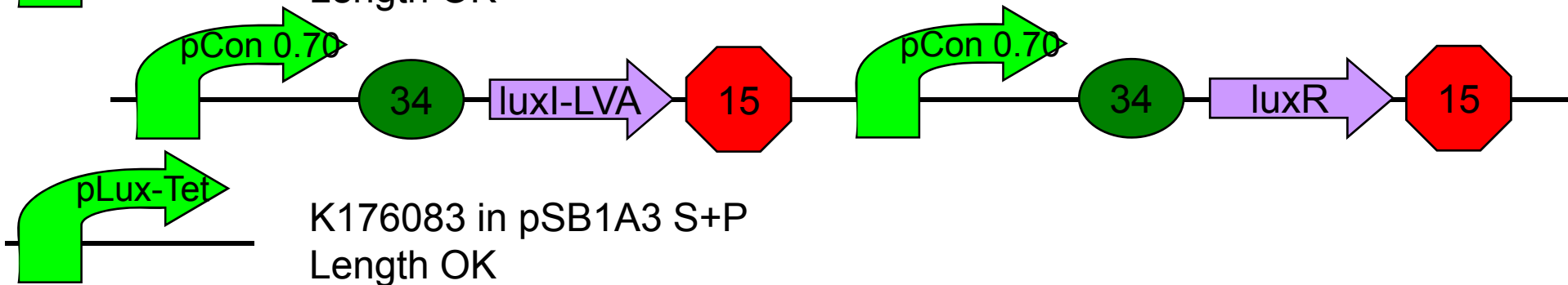

K176083 in pSB1A3 S+P
Length OK

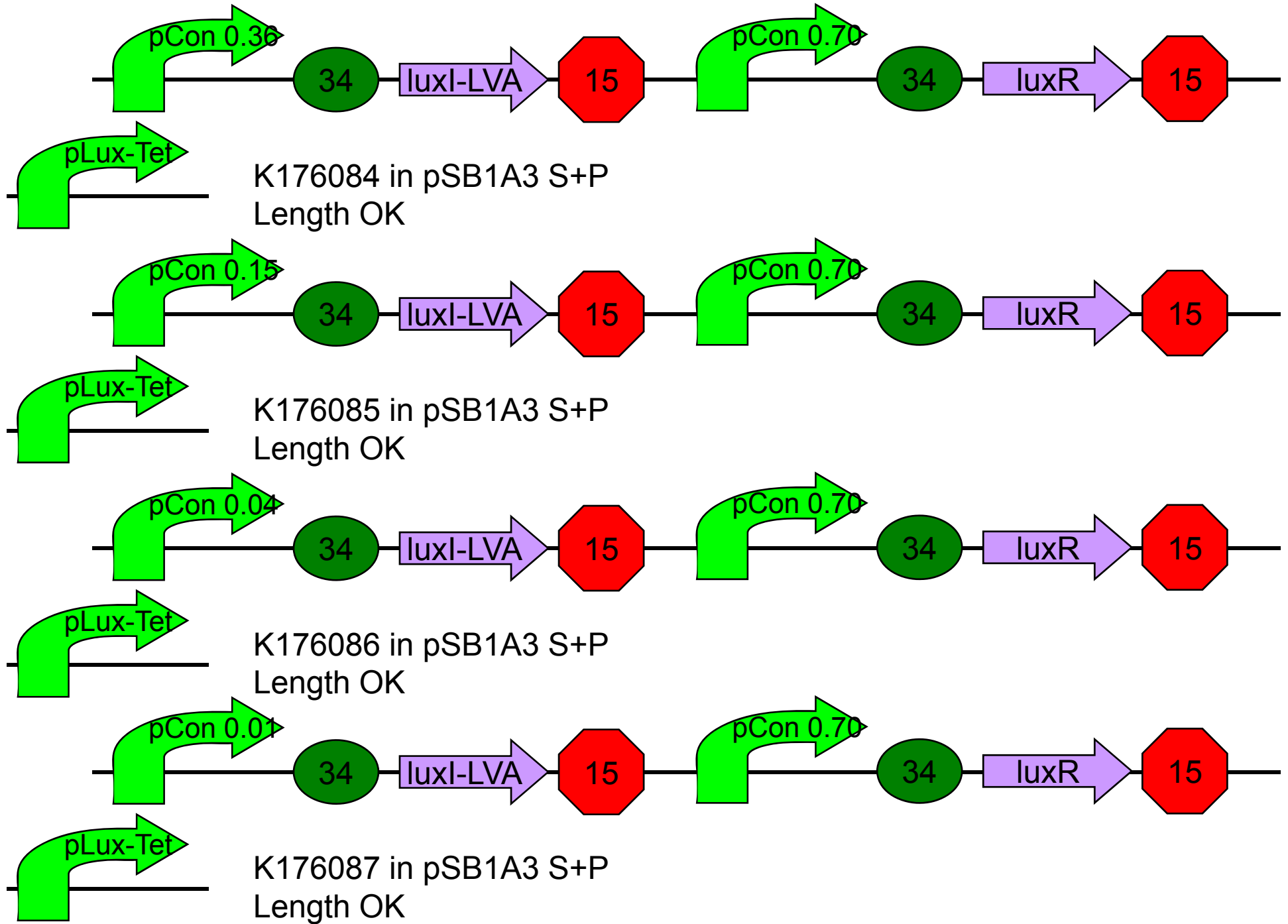

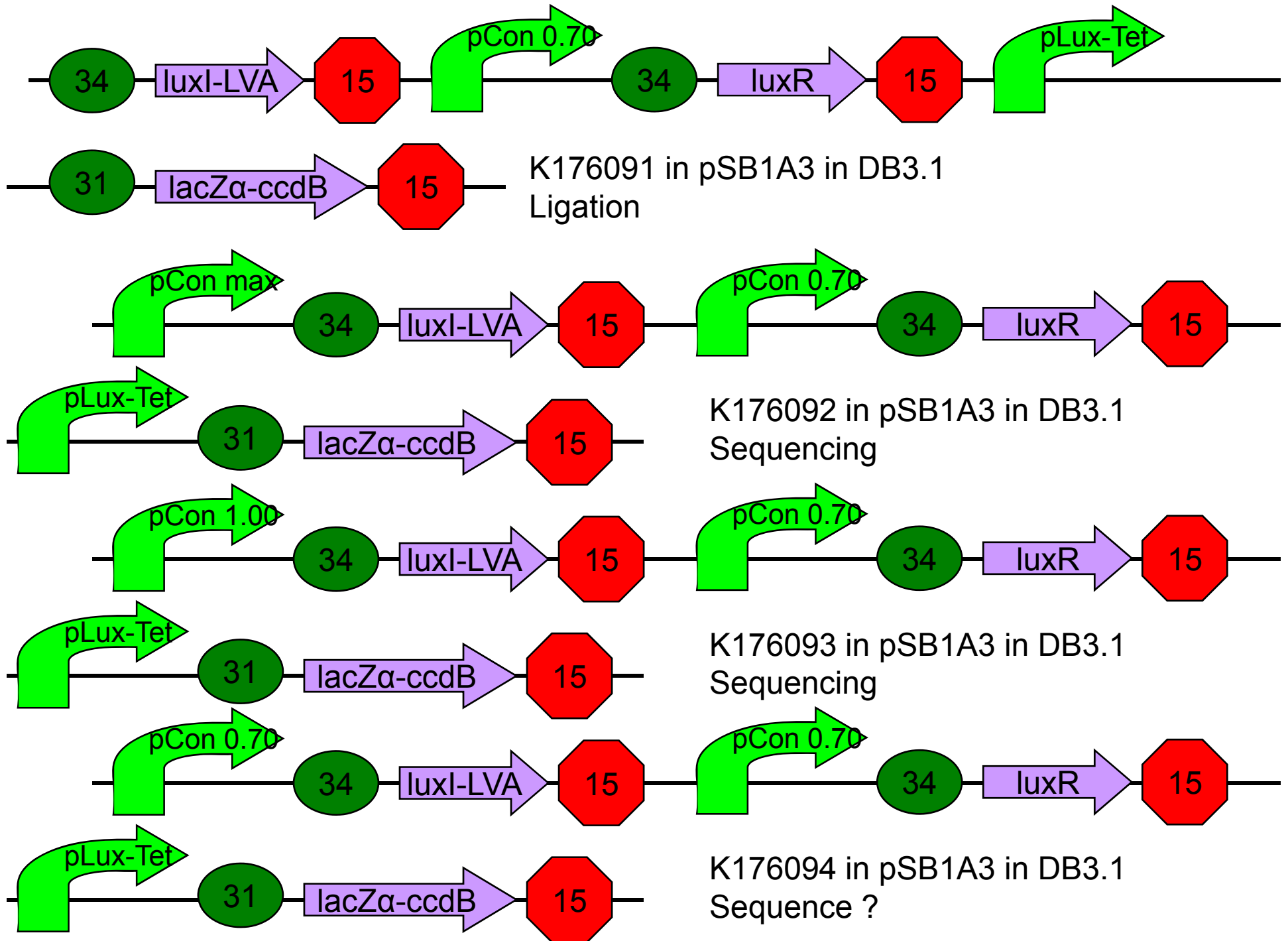

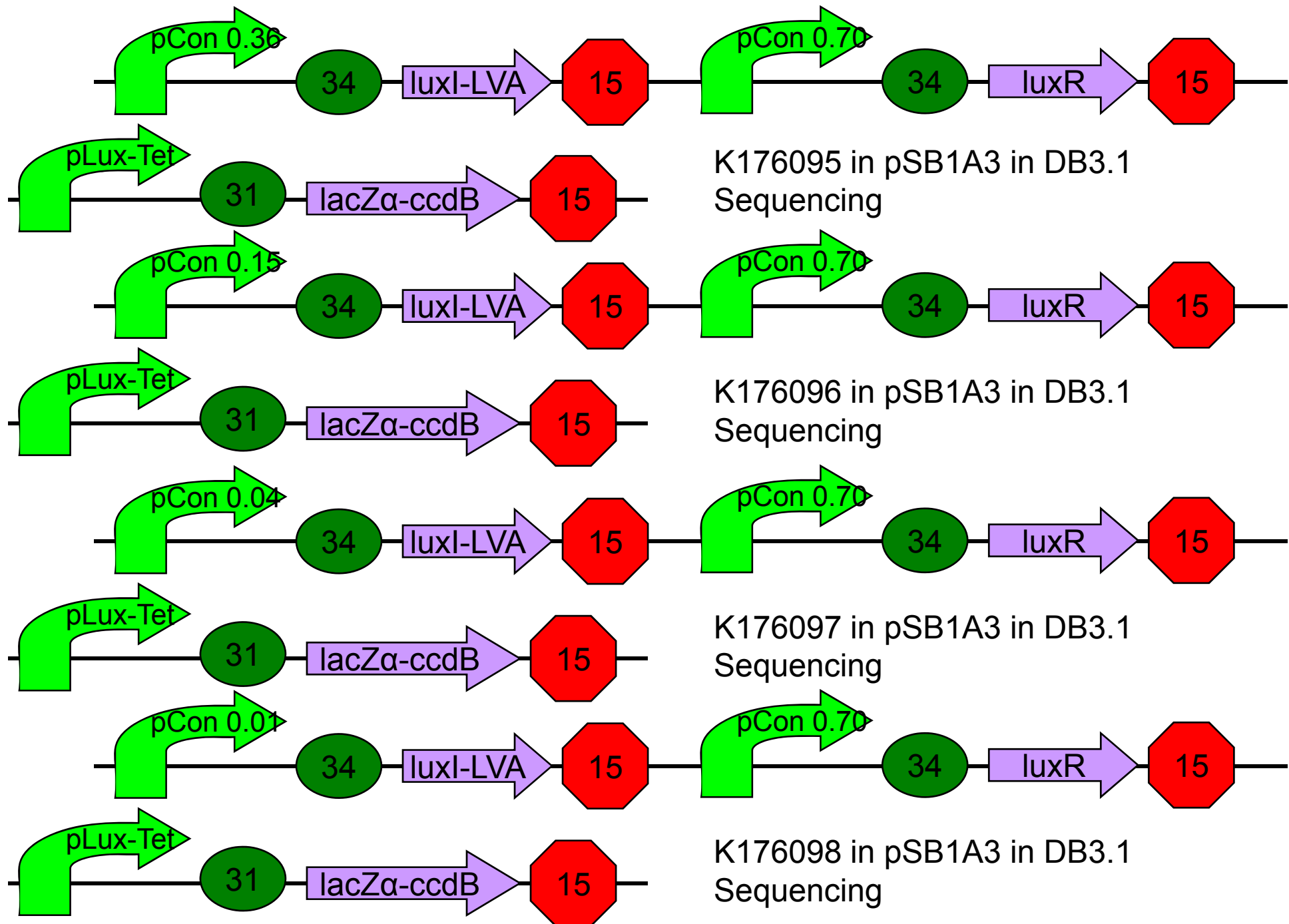

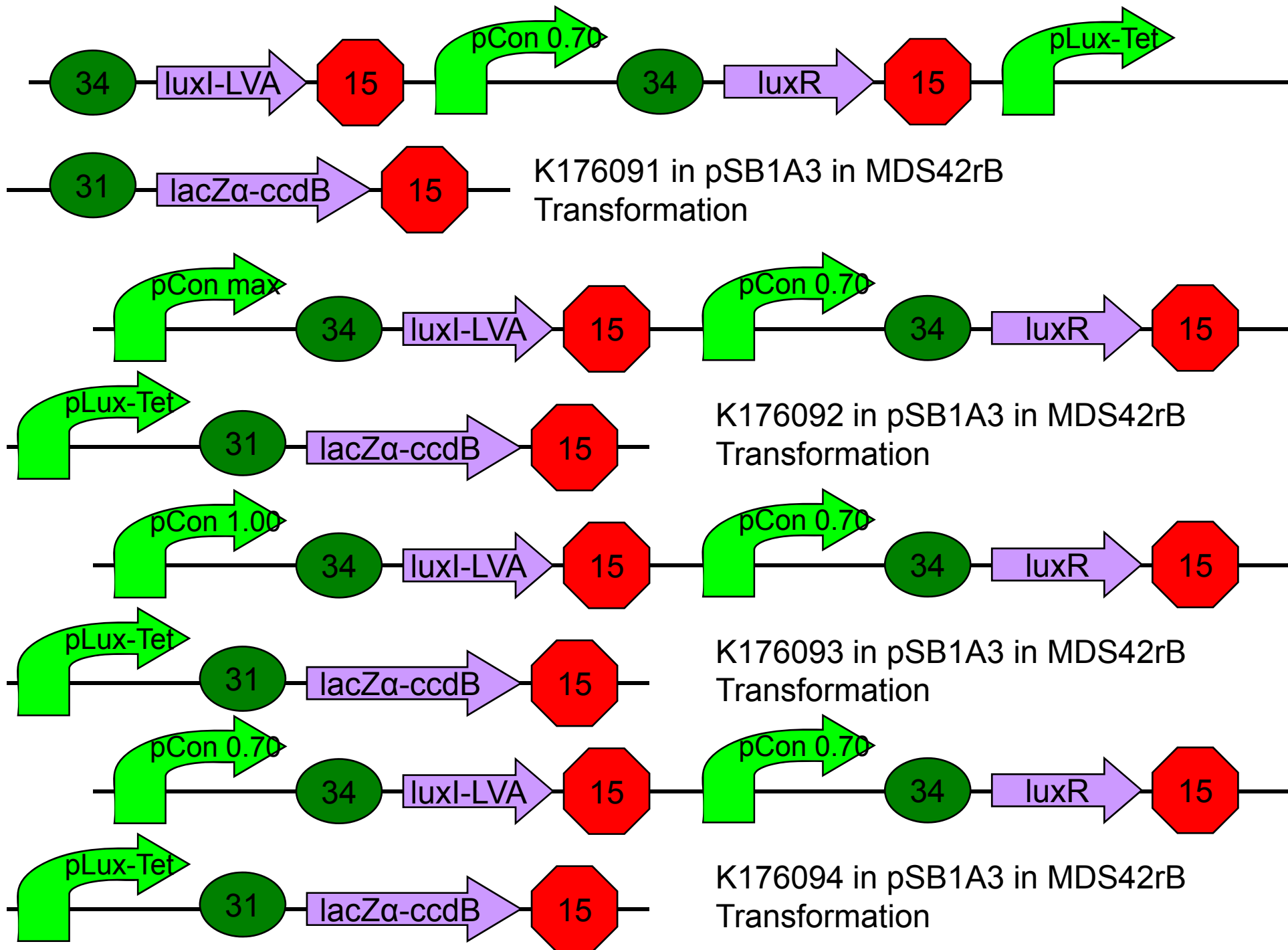

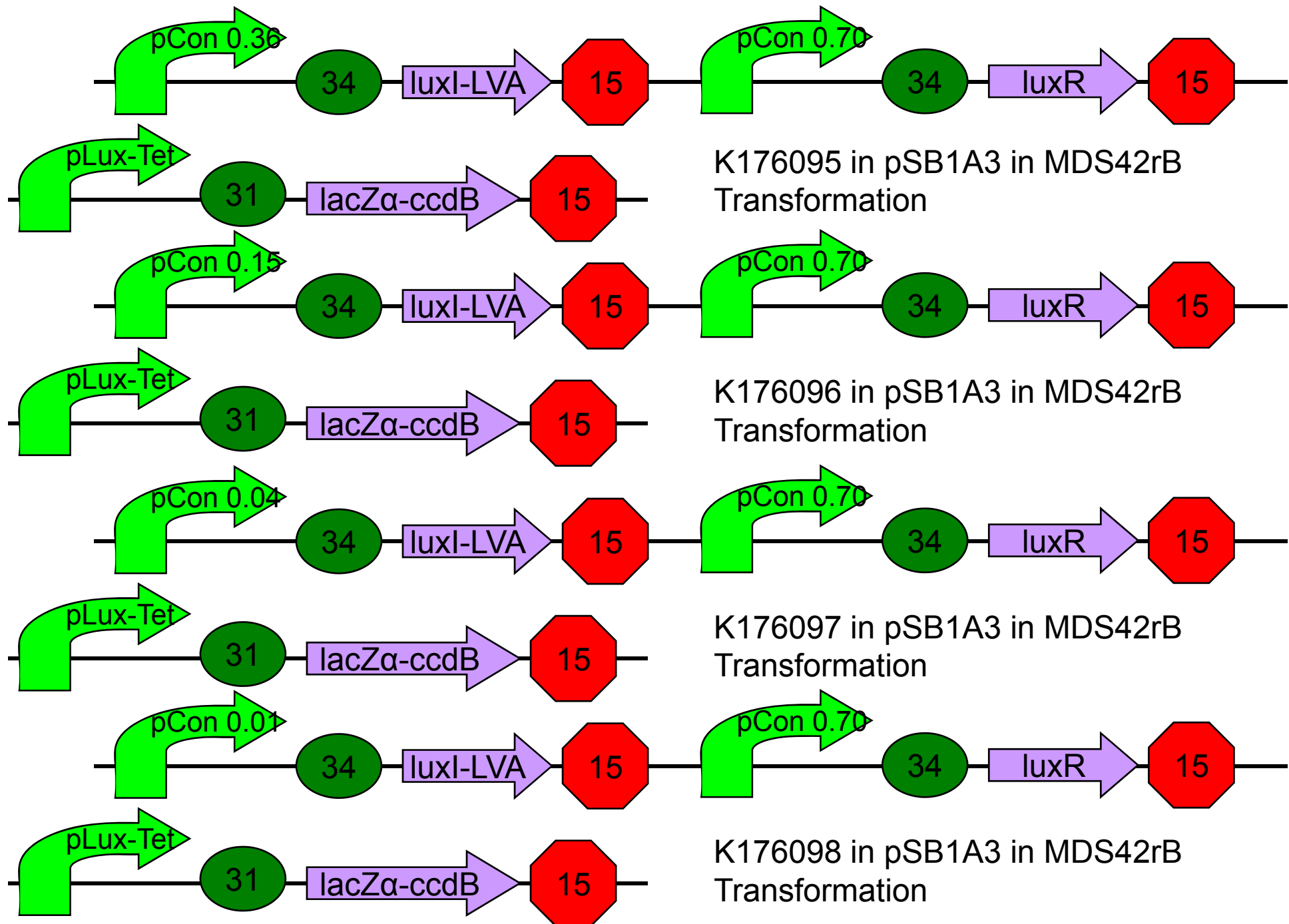

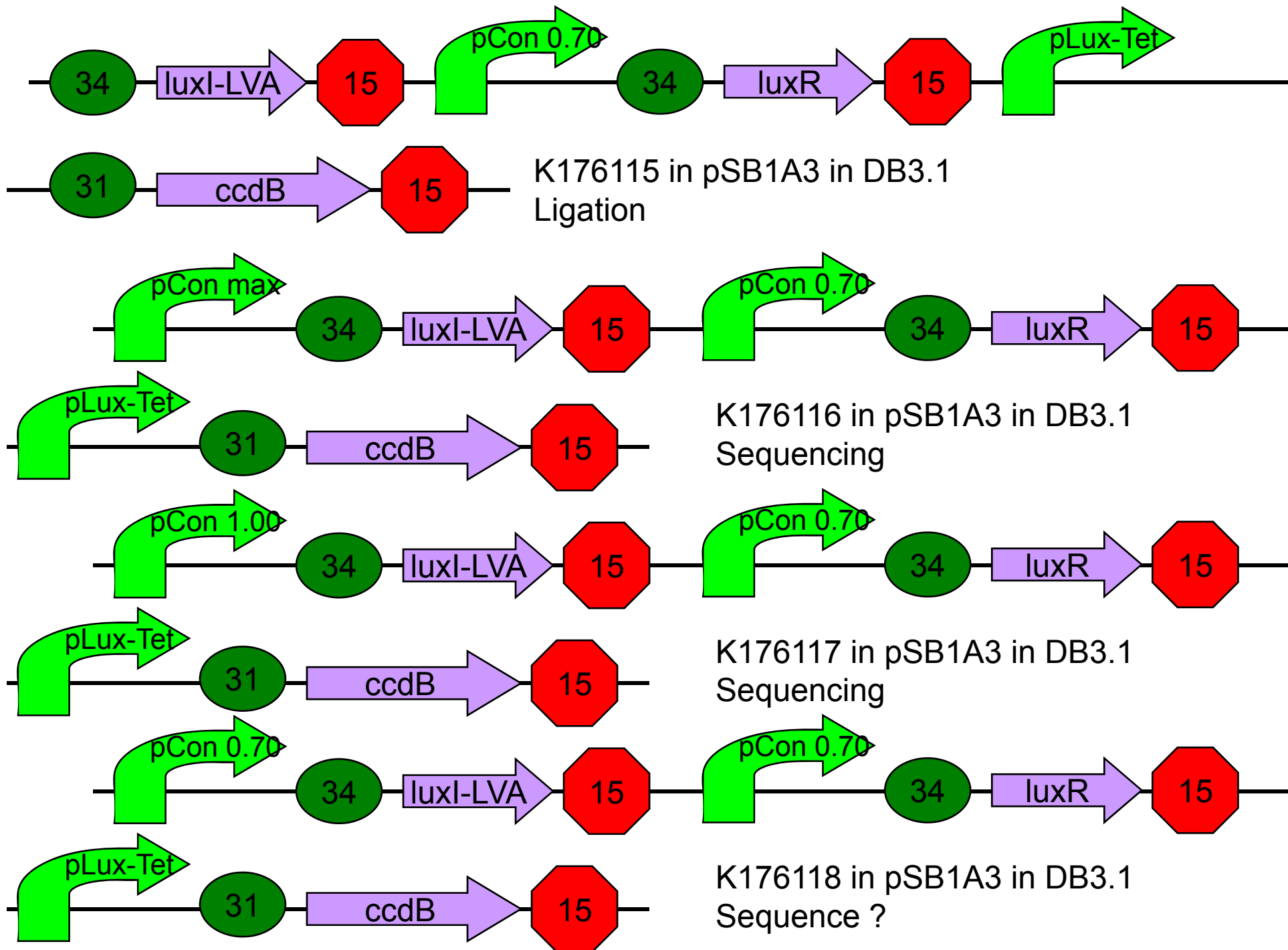

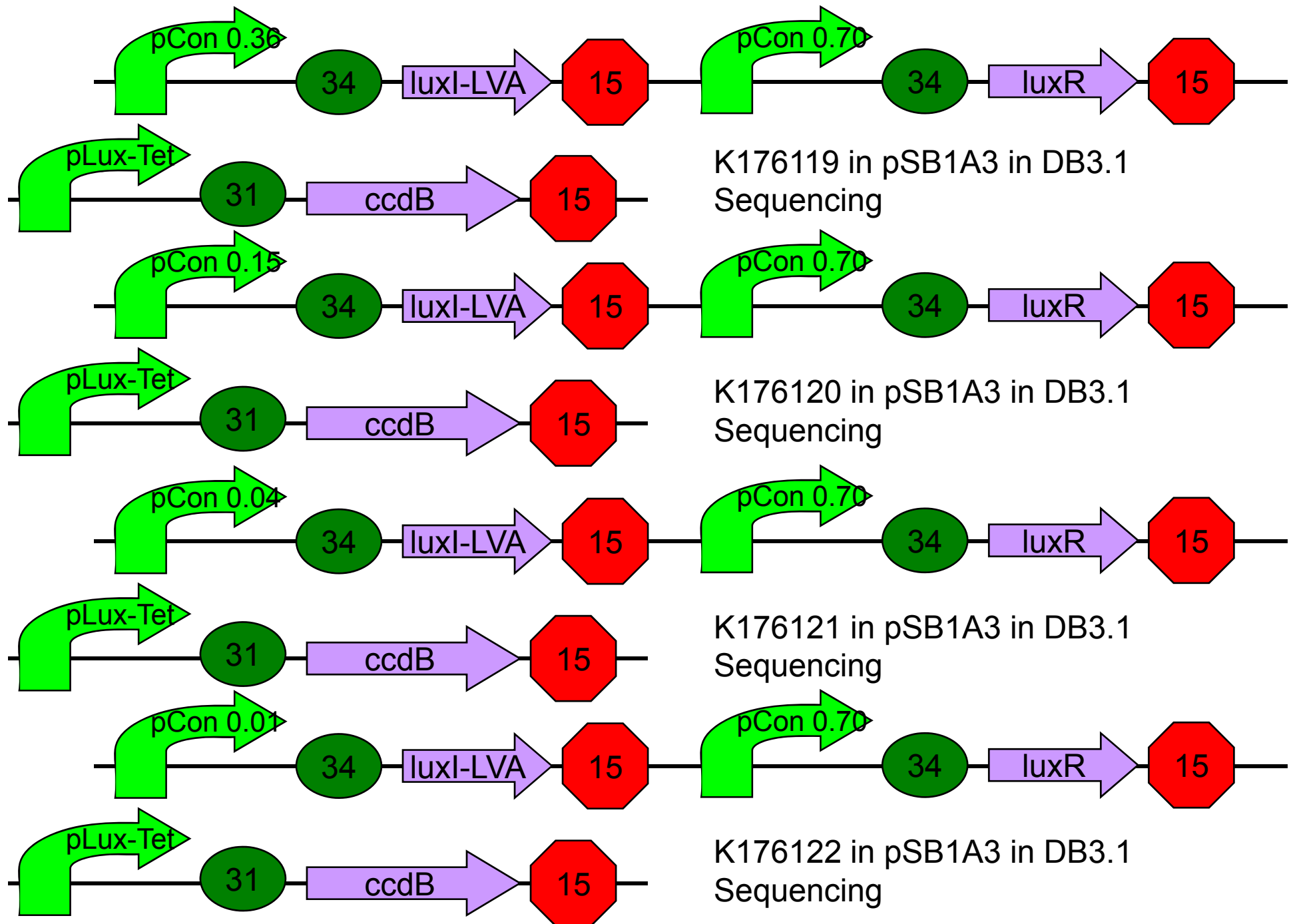

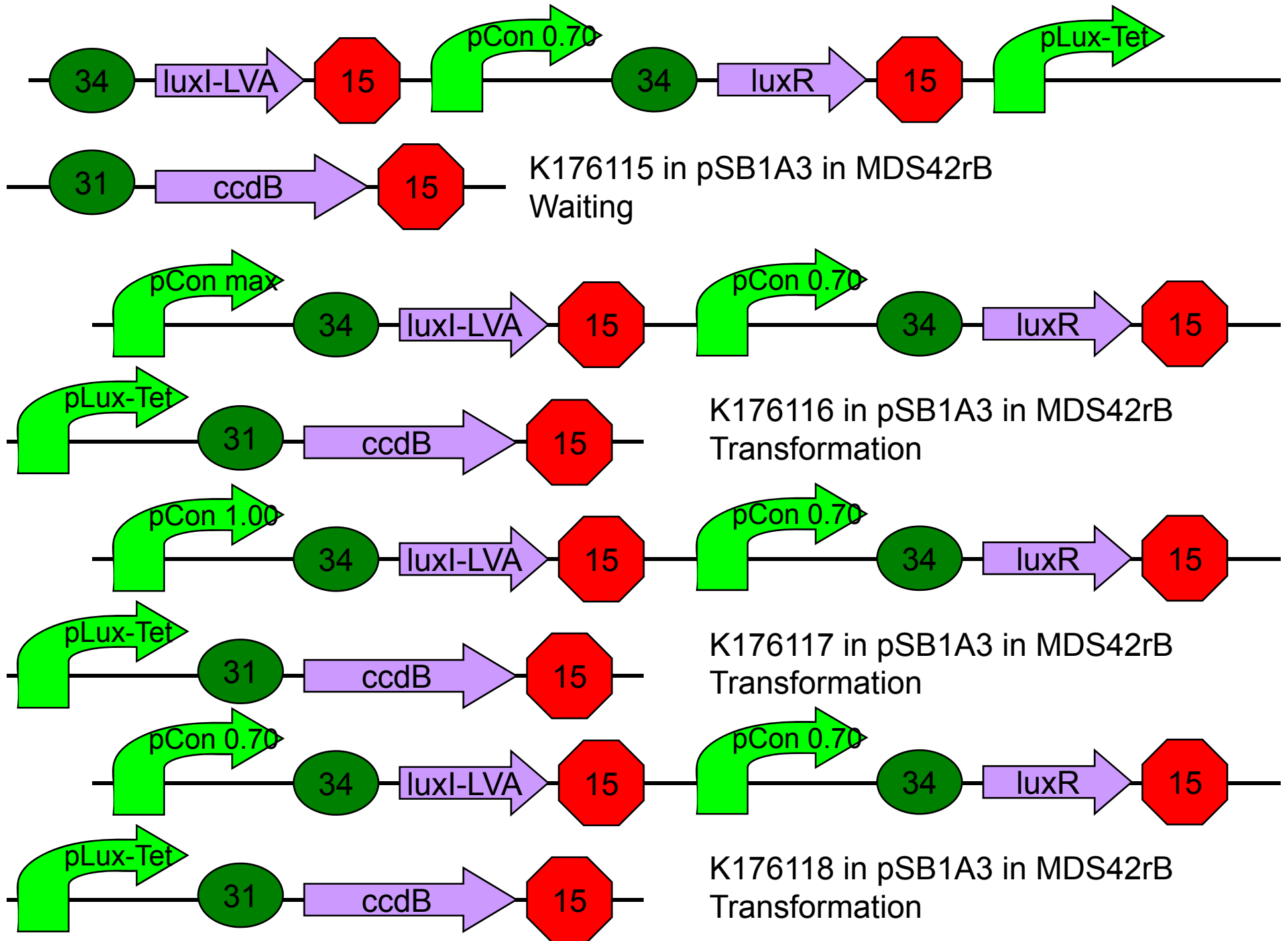

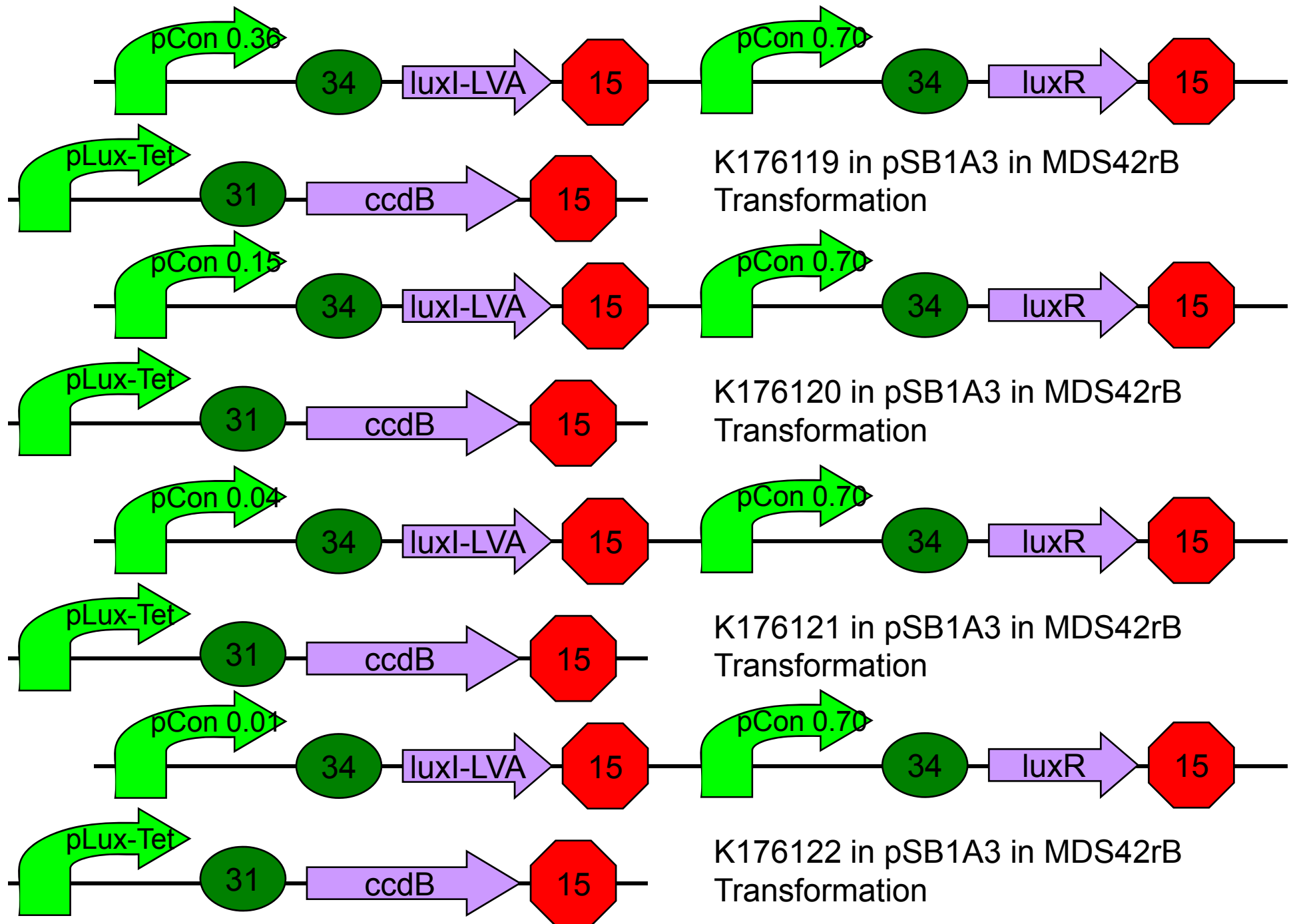

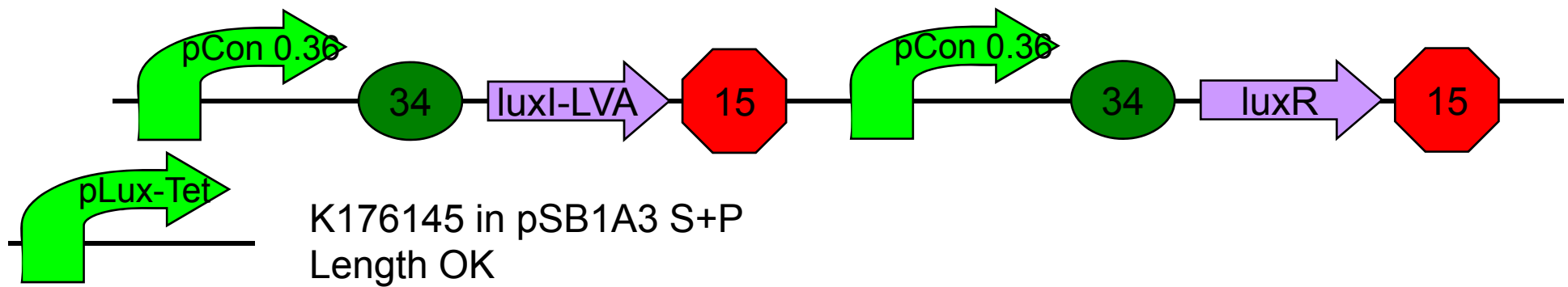
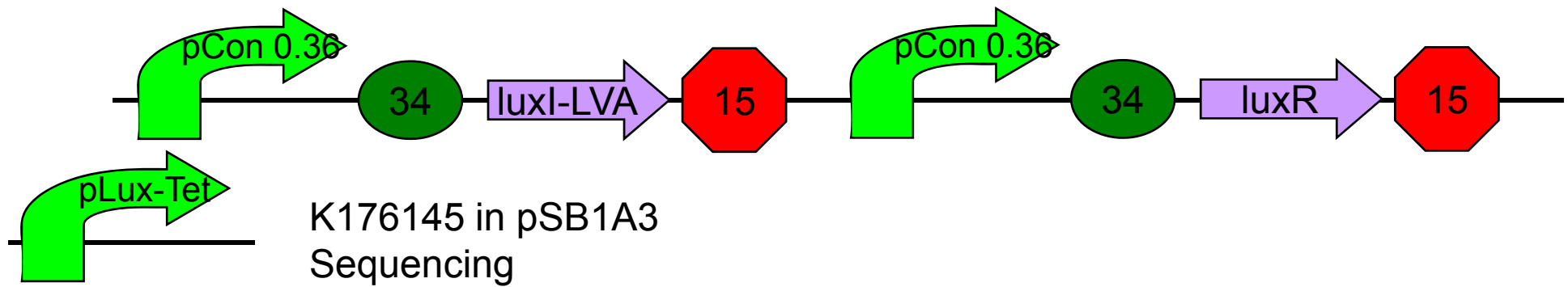
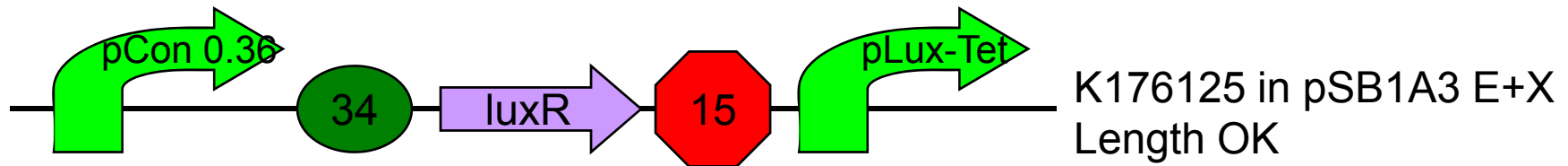

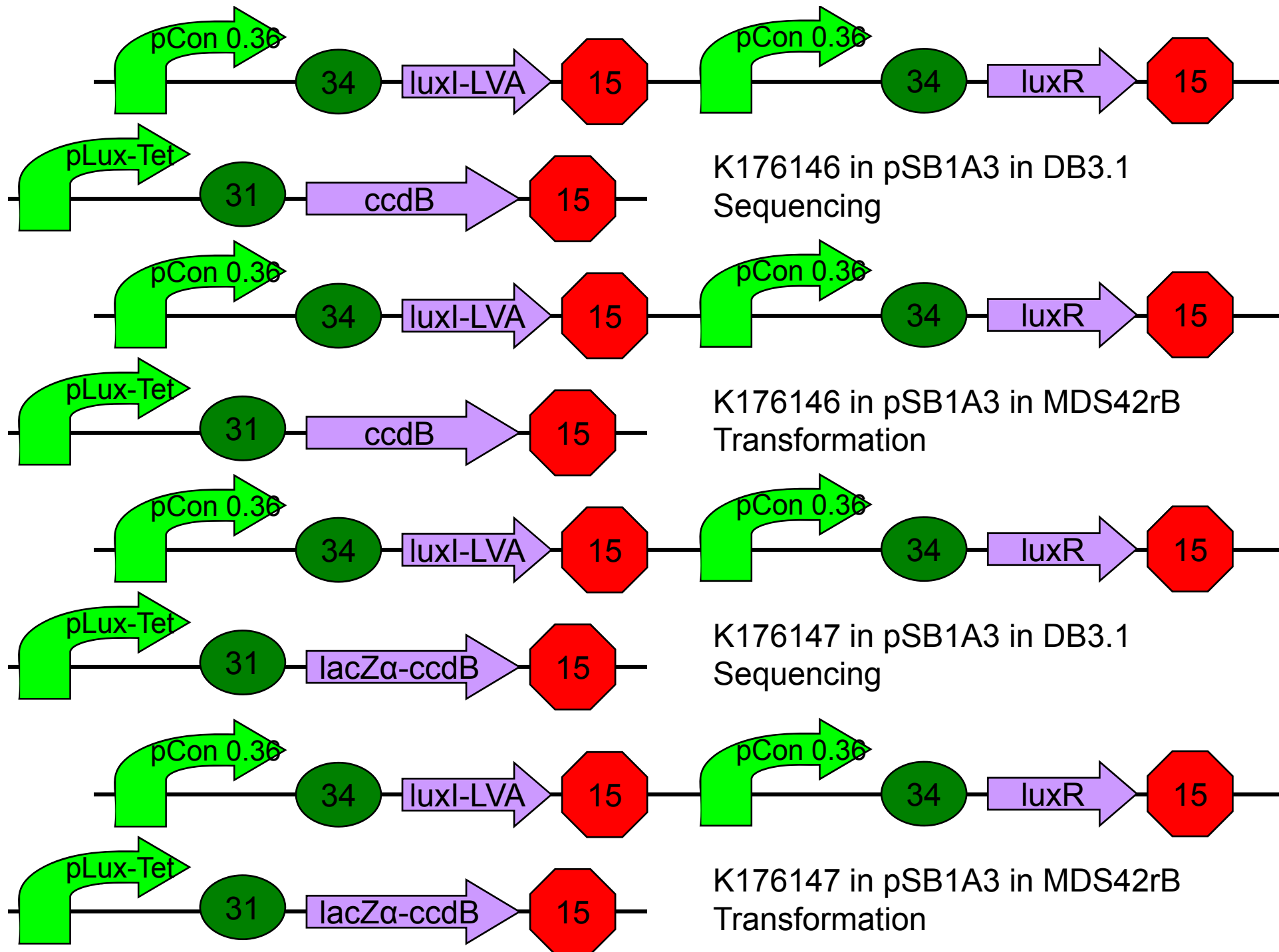

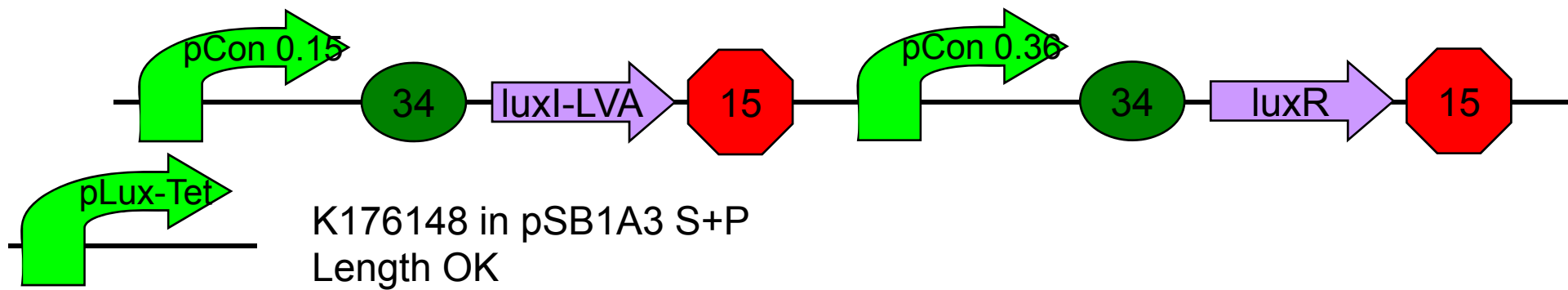
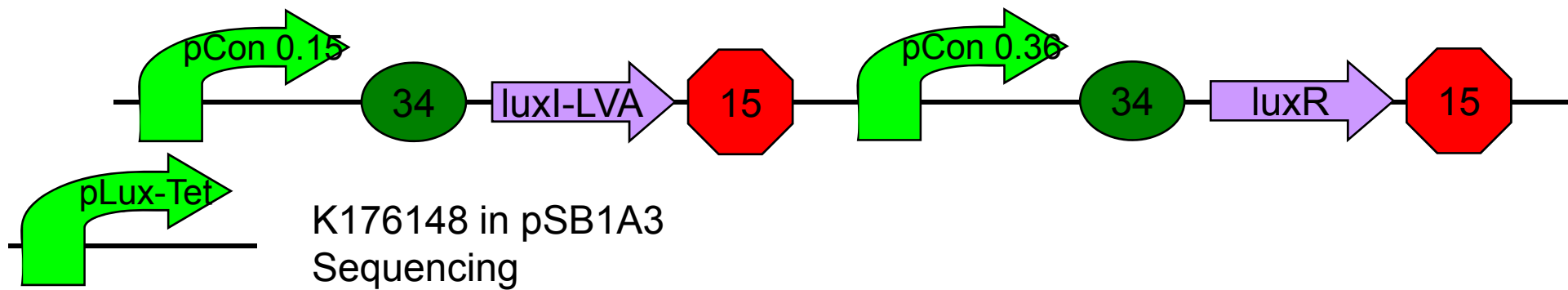

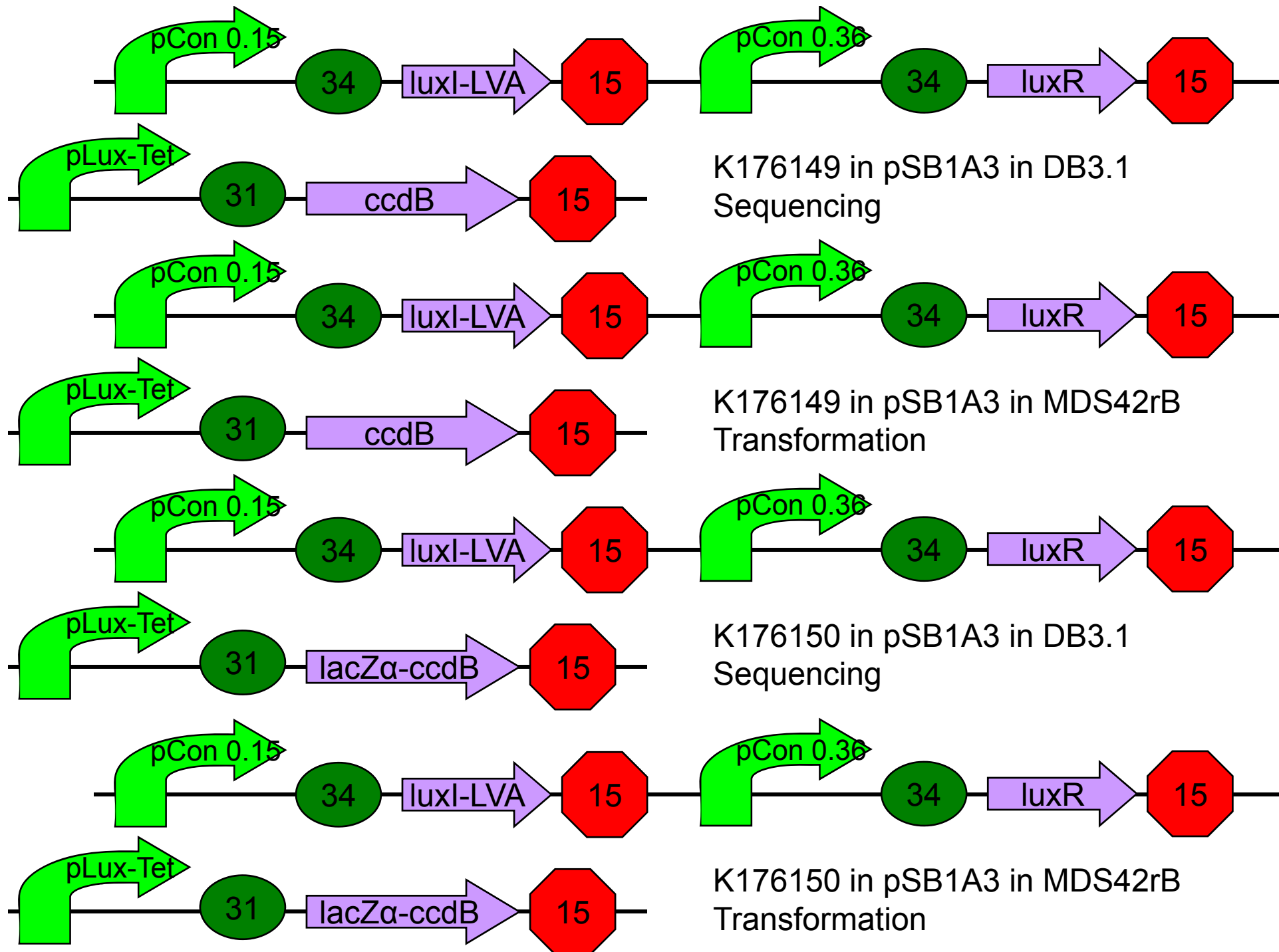

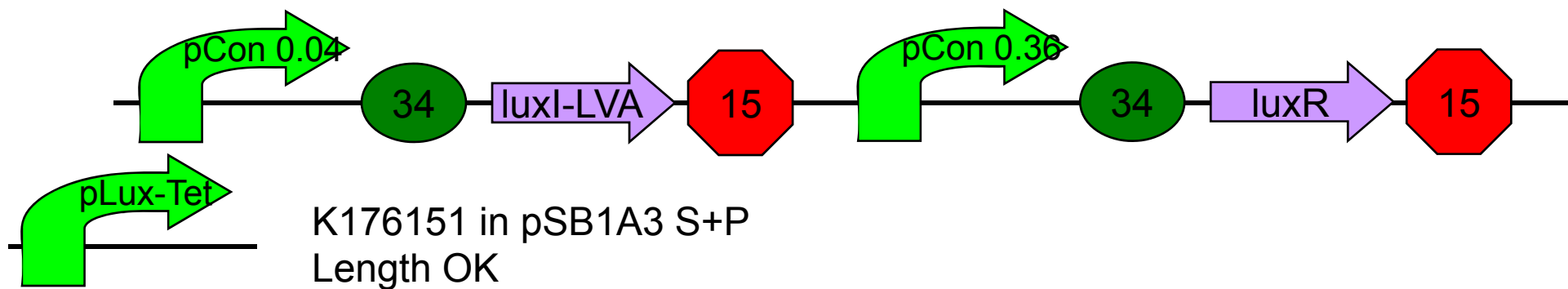
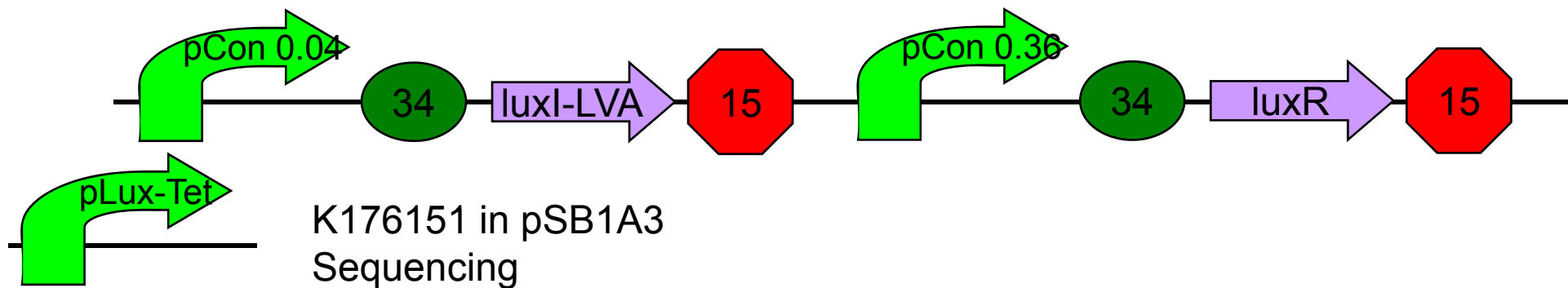

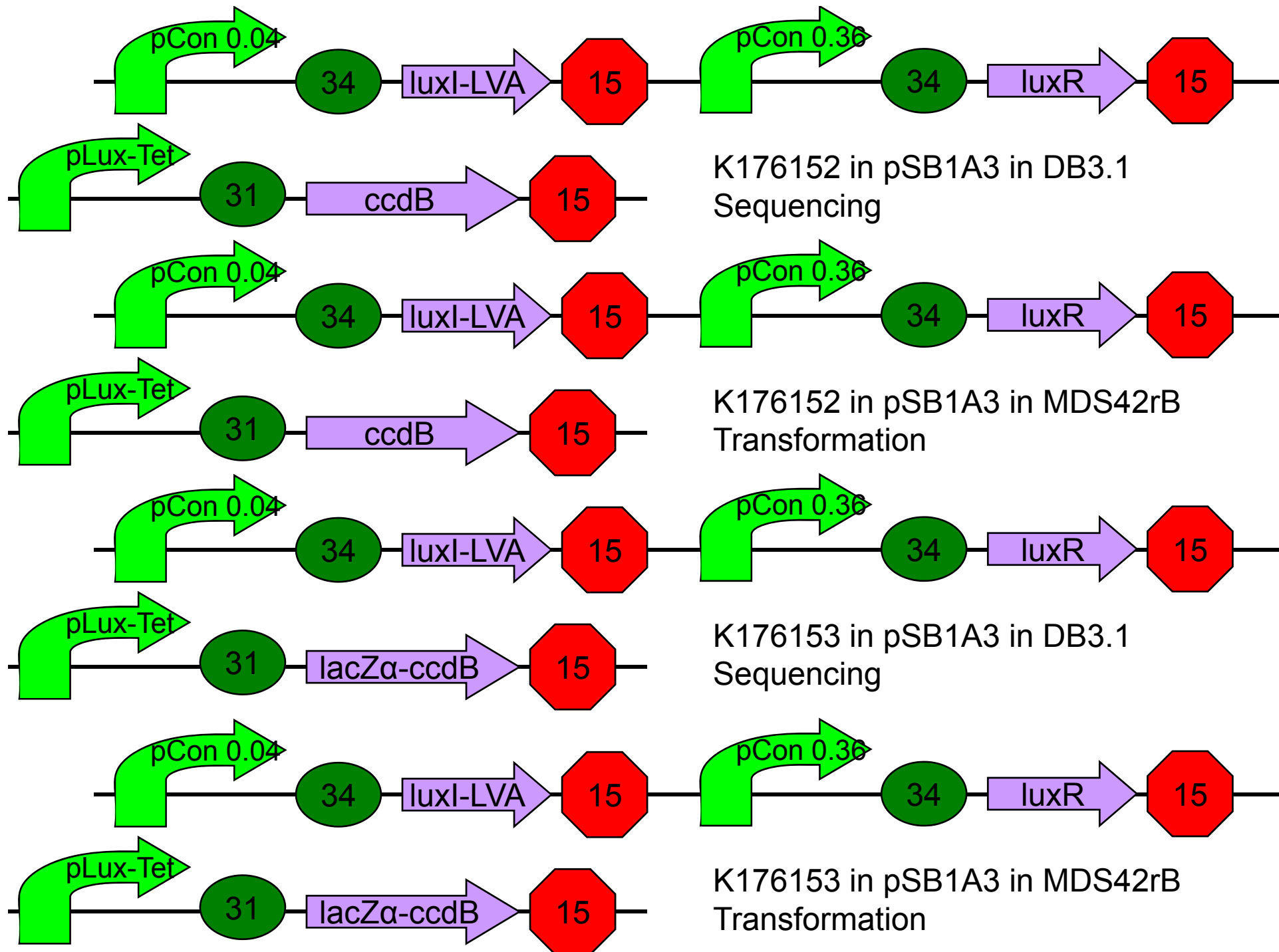

pCon 0.04 luxI + luxR + B0031 lacZ α -ccdB

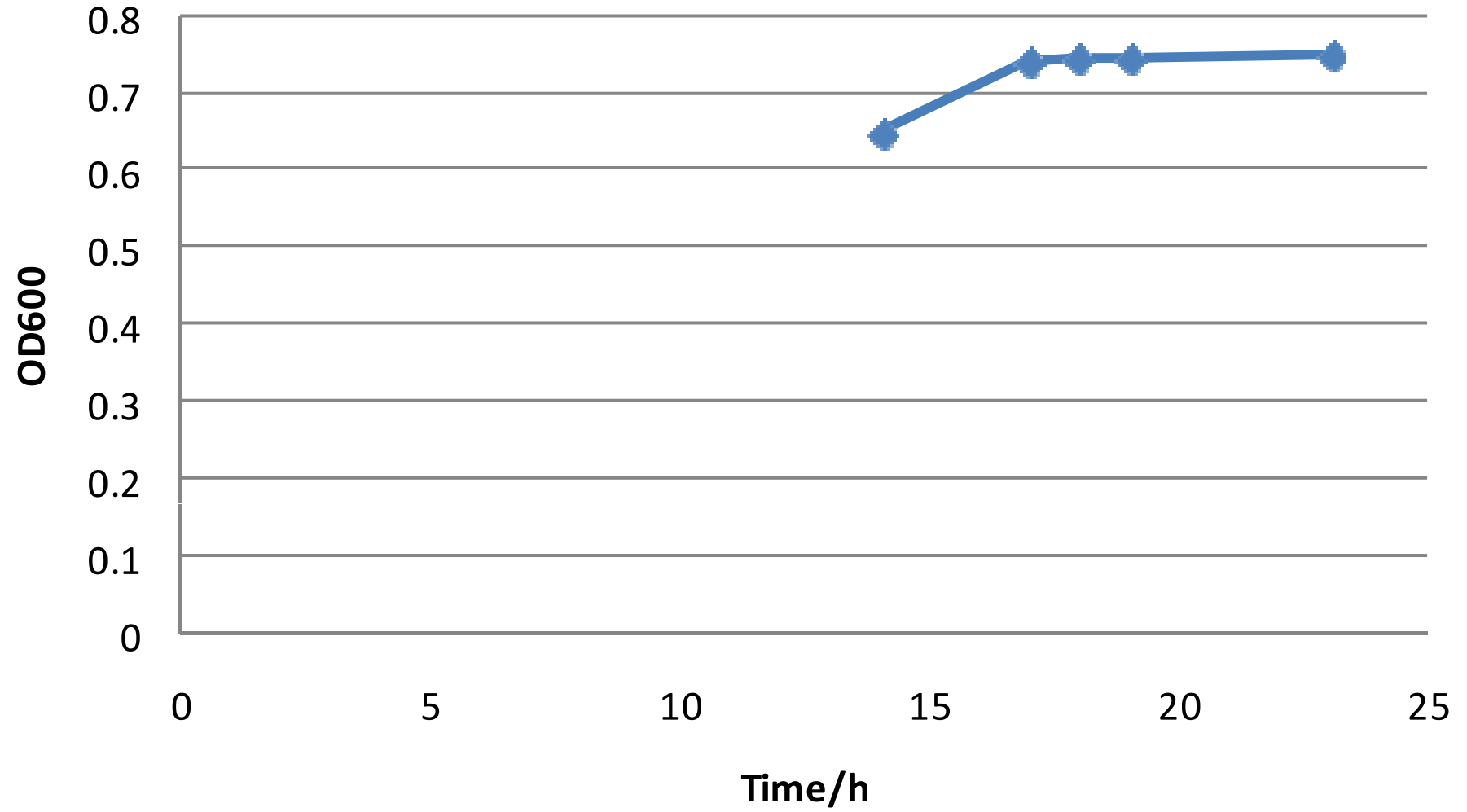

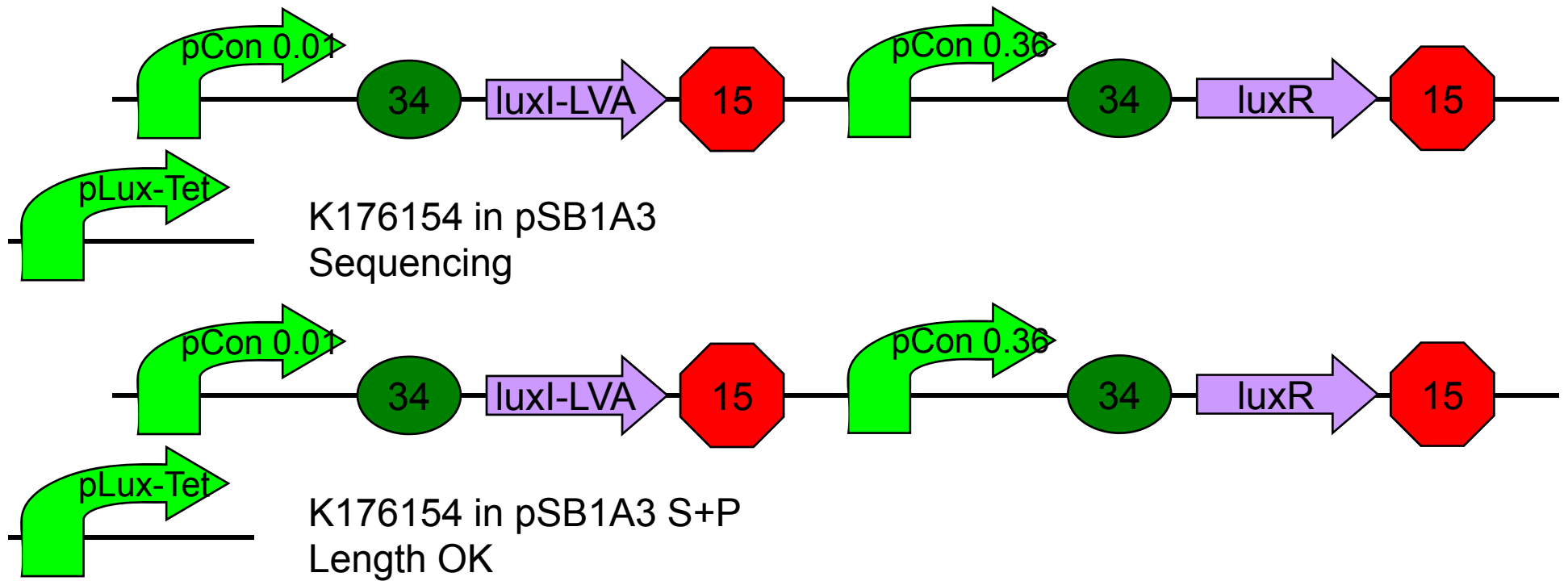

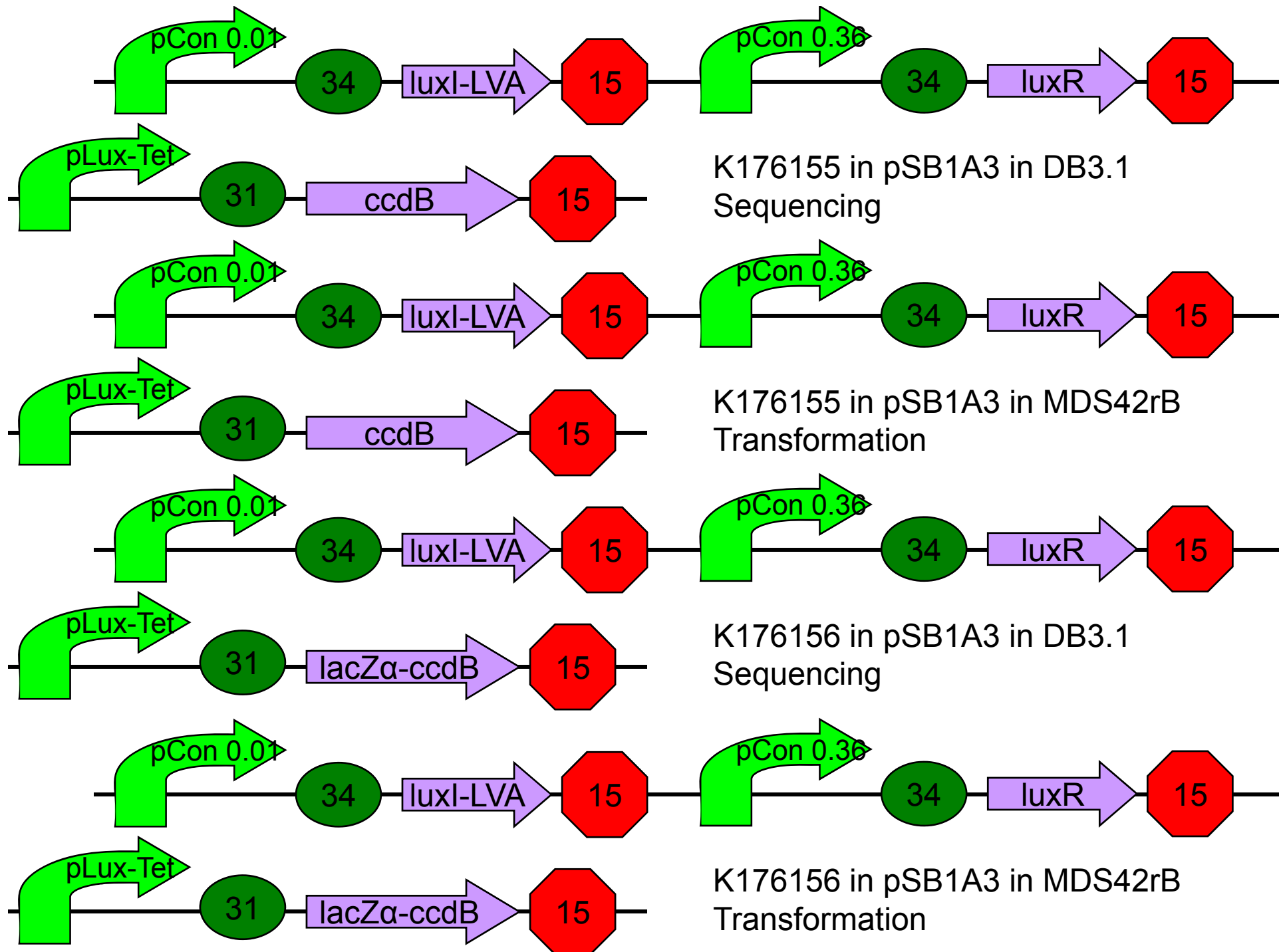

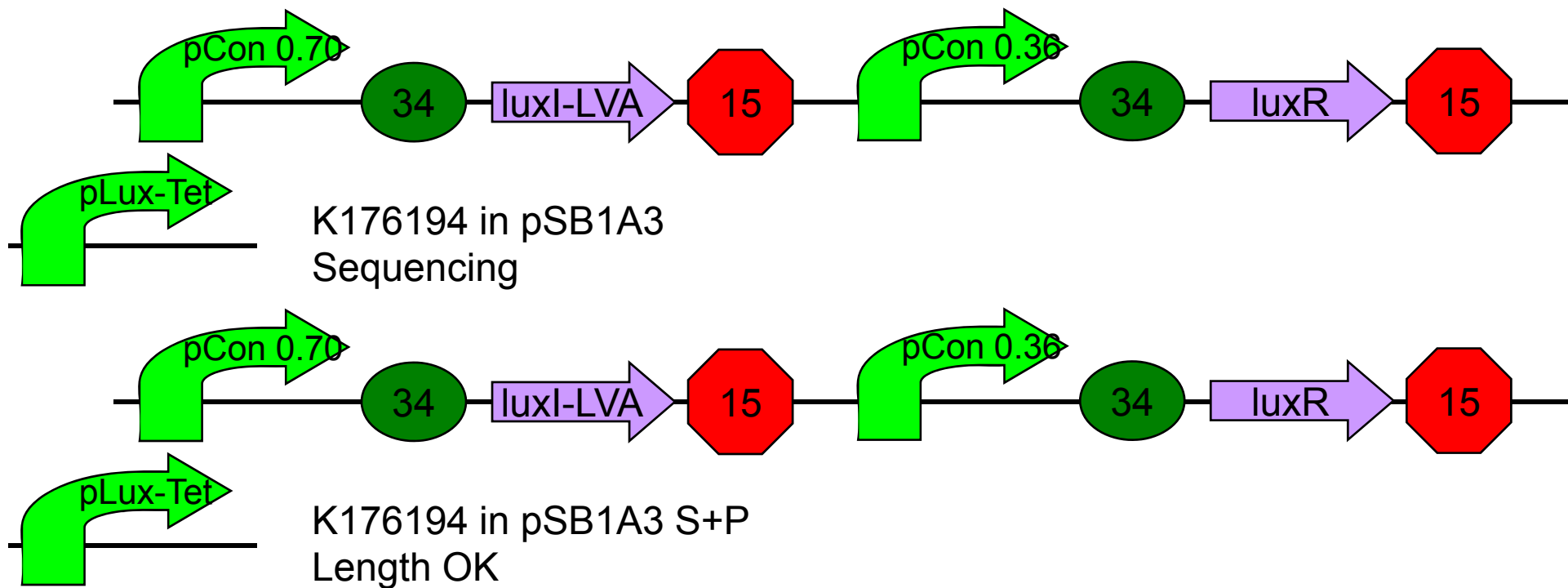

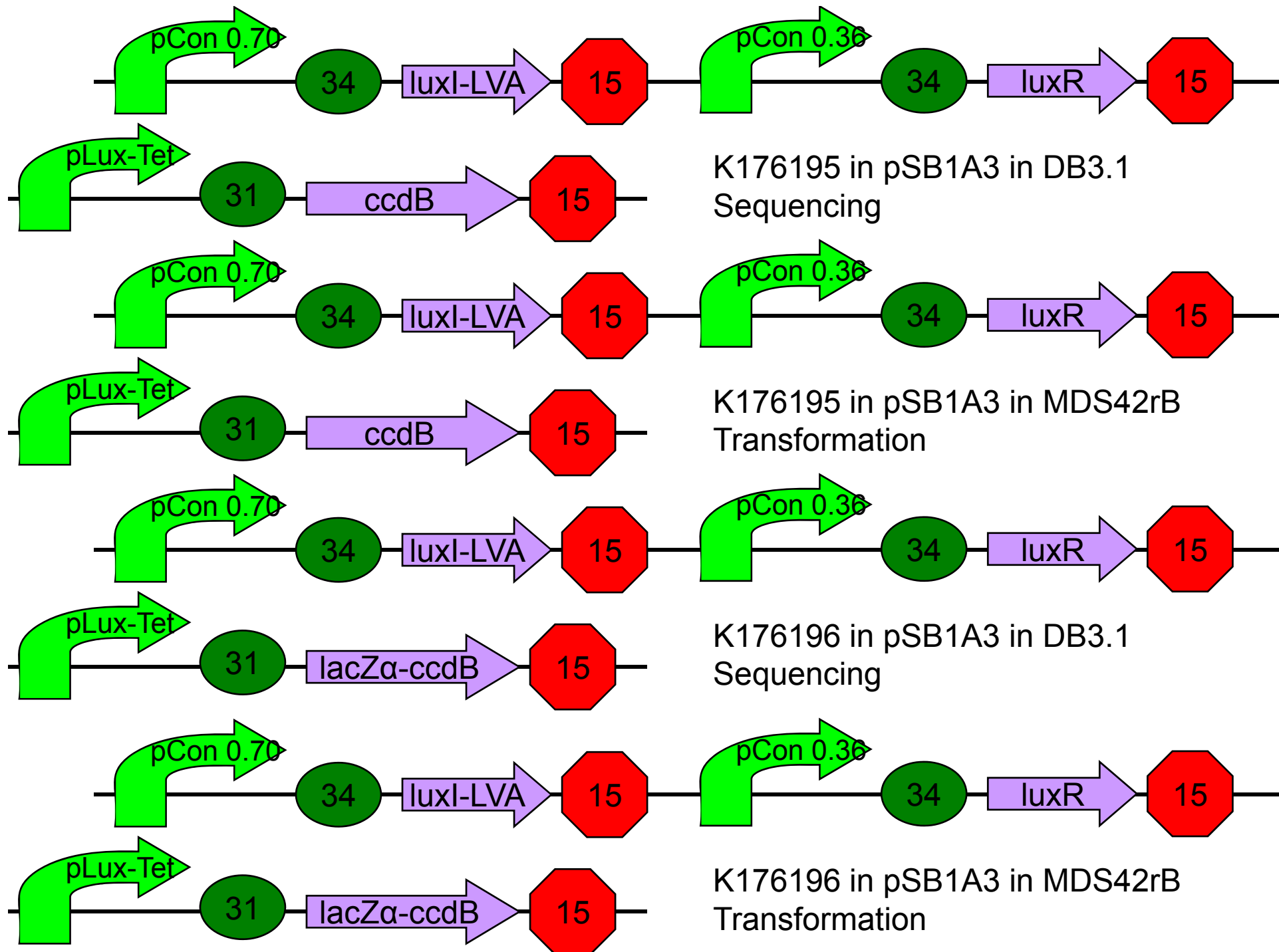

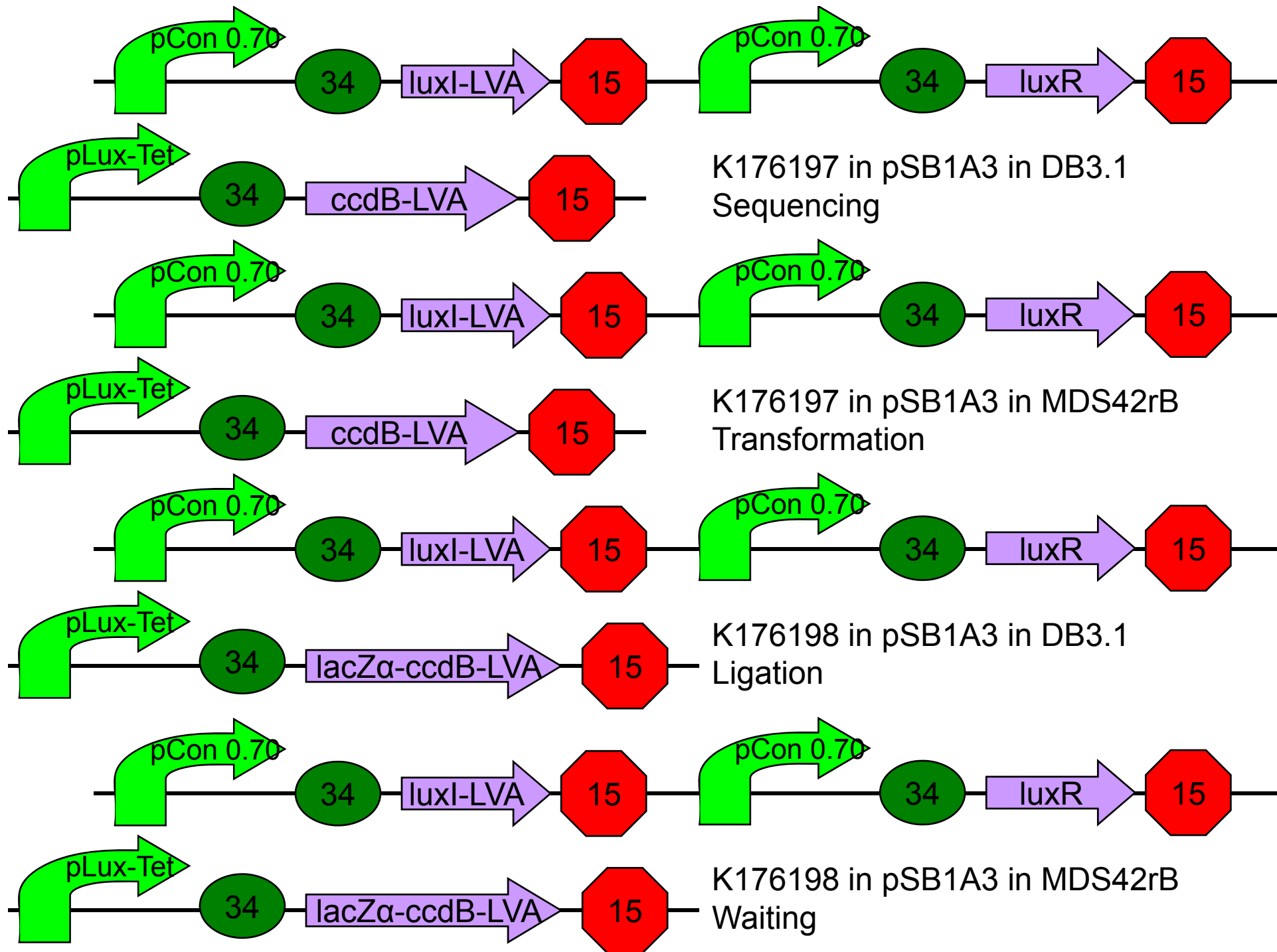

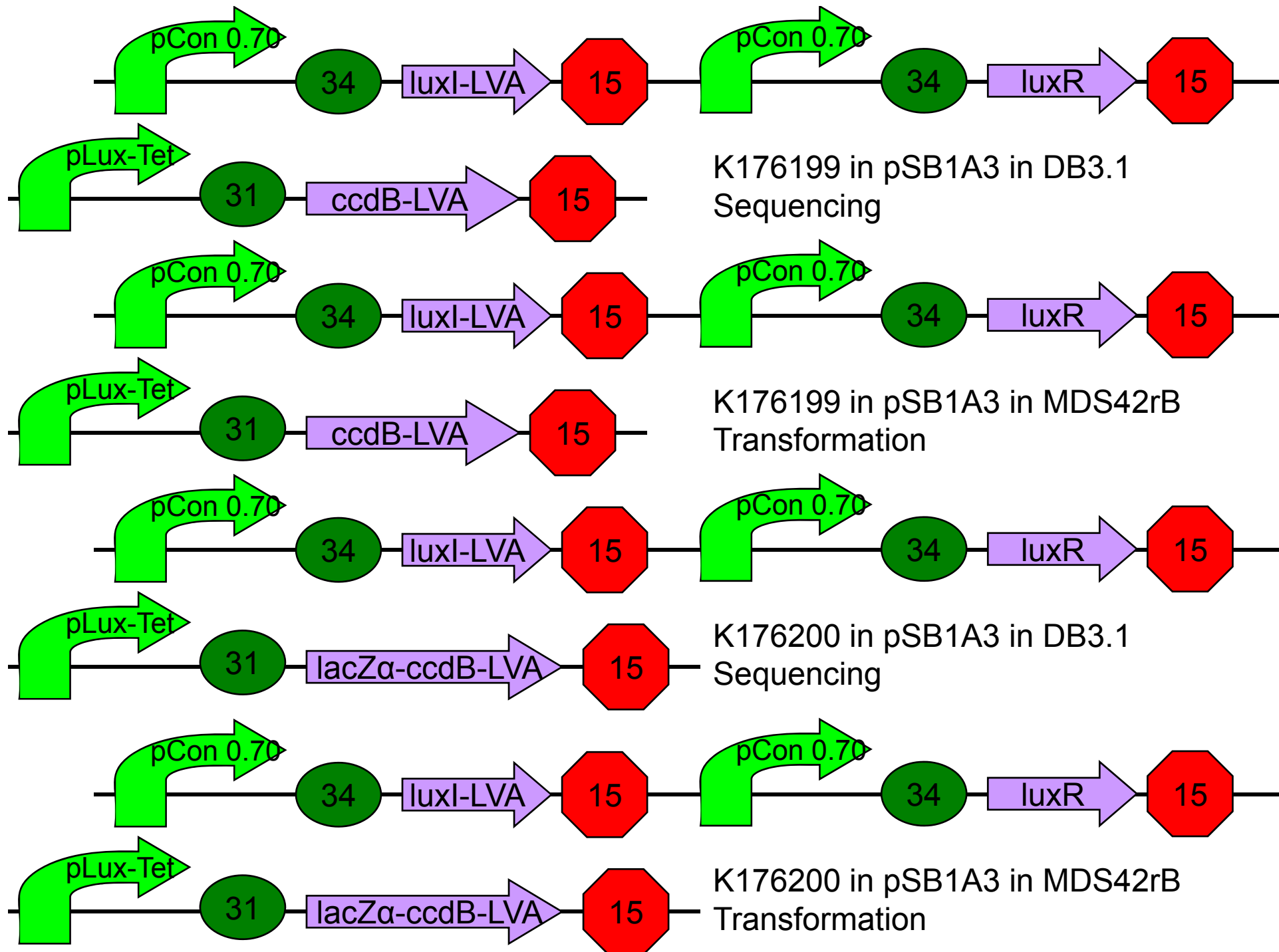

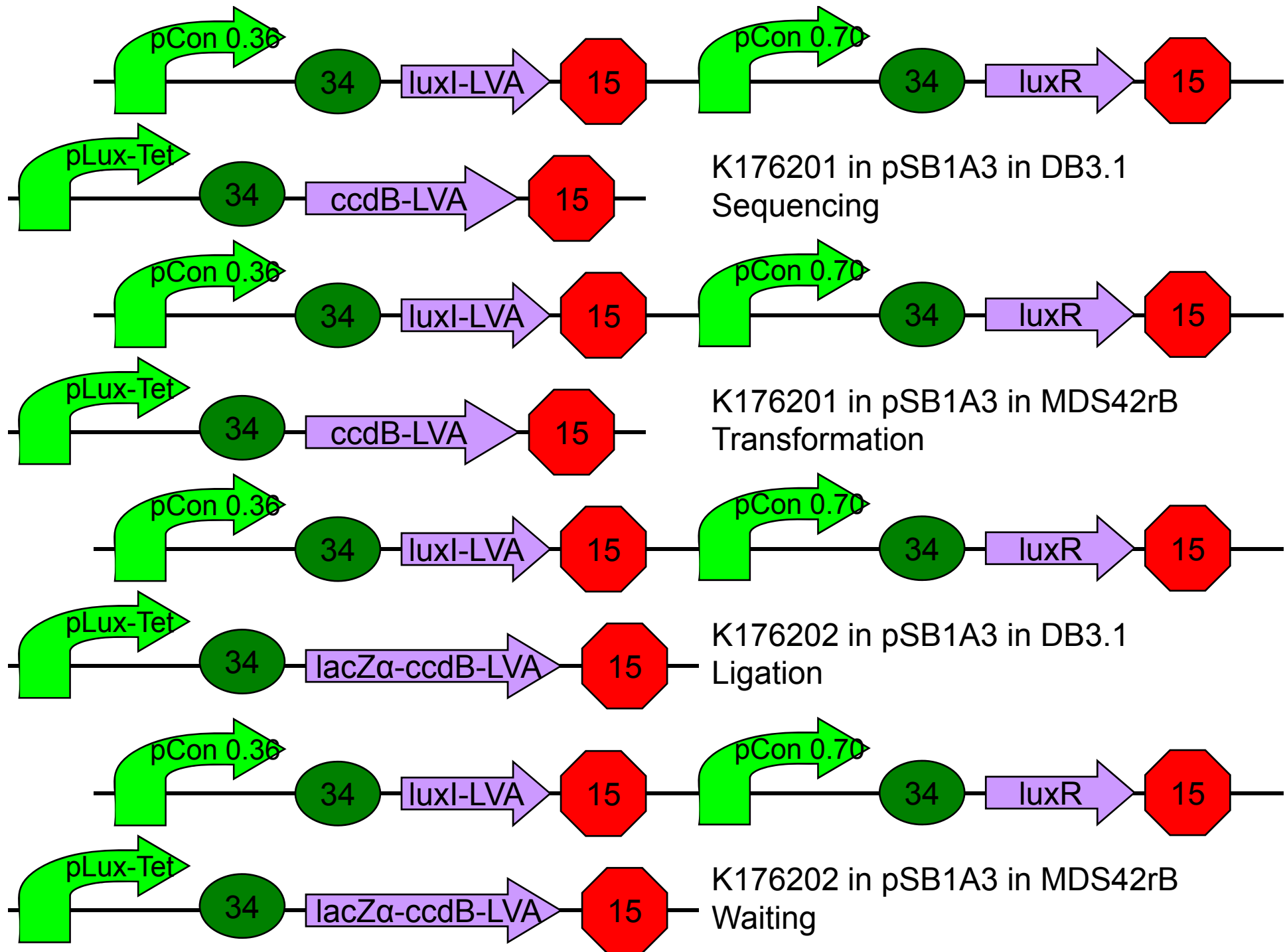

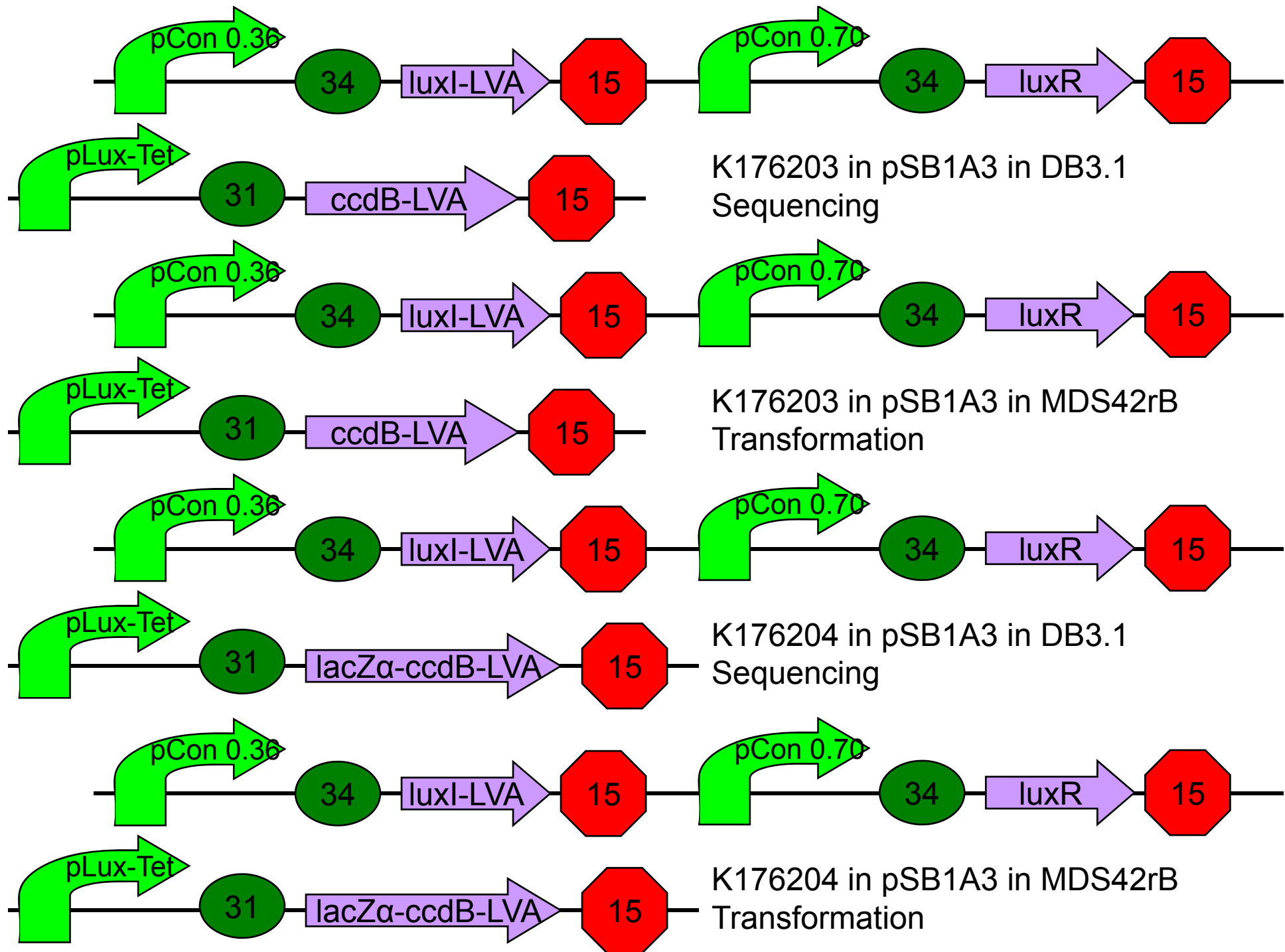

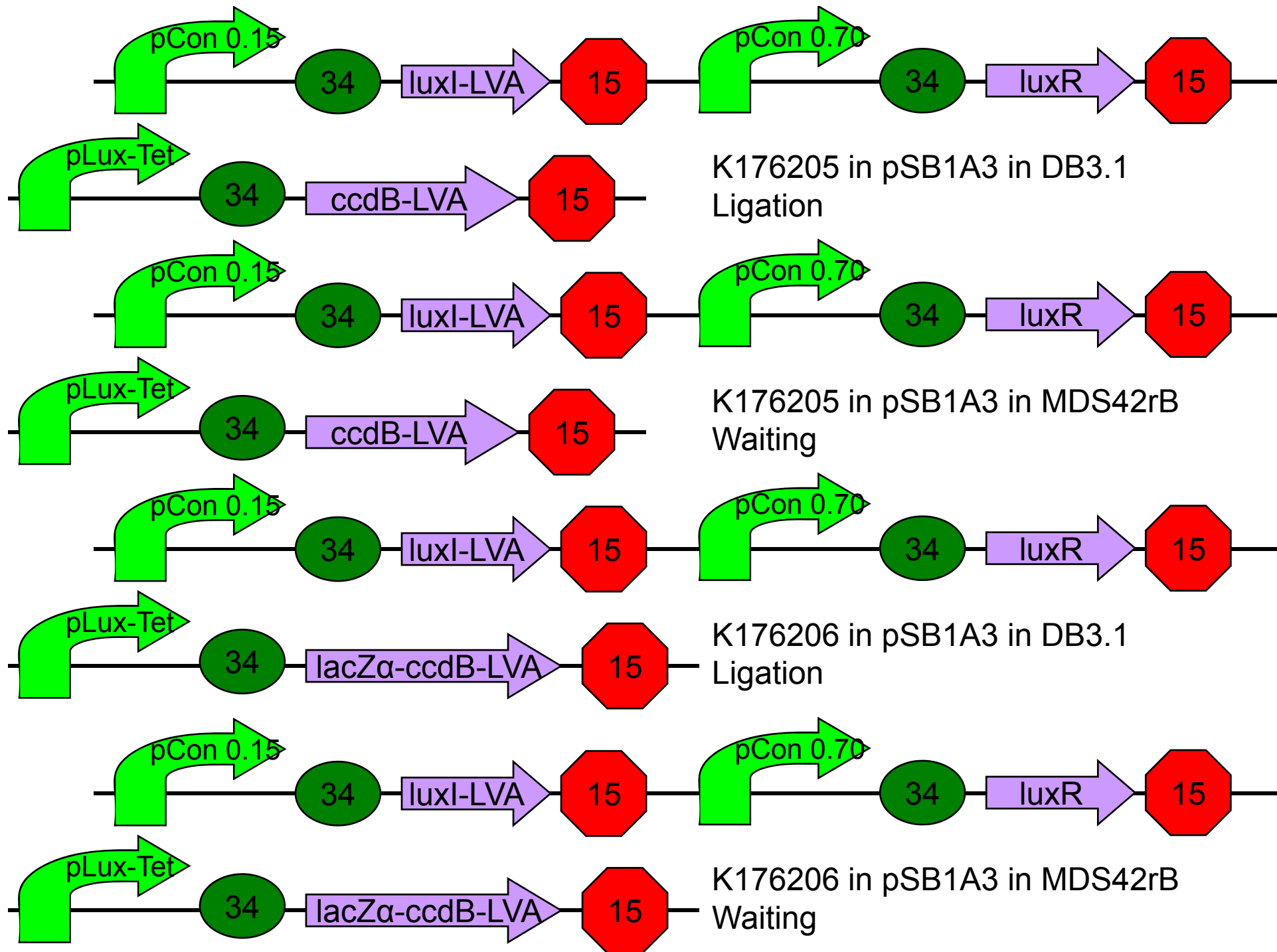

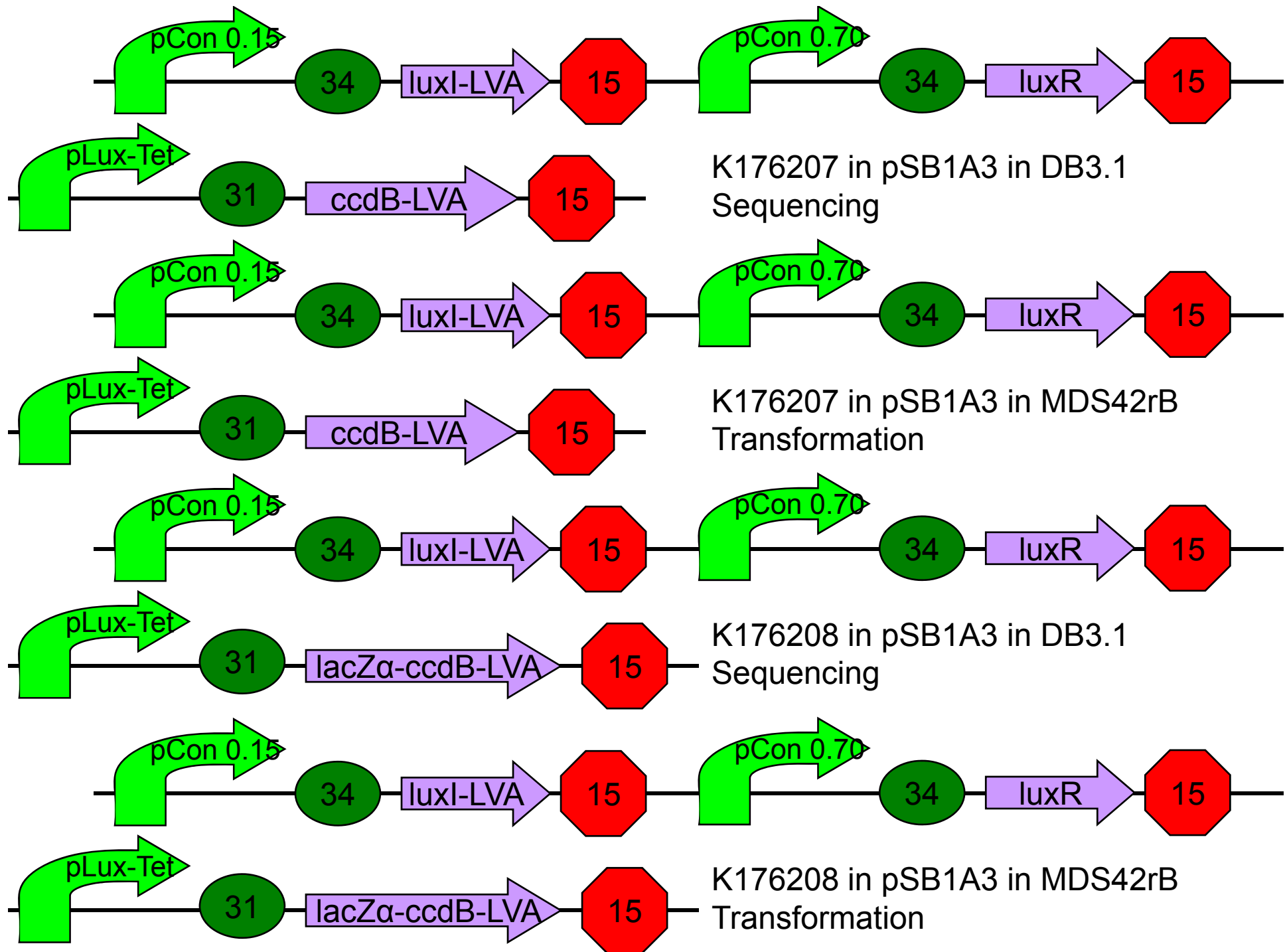

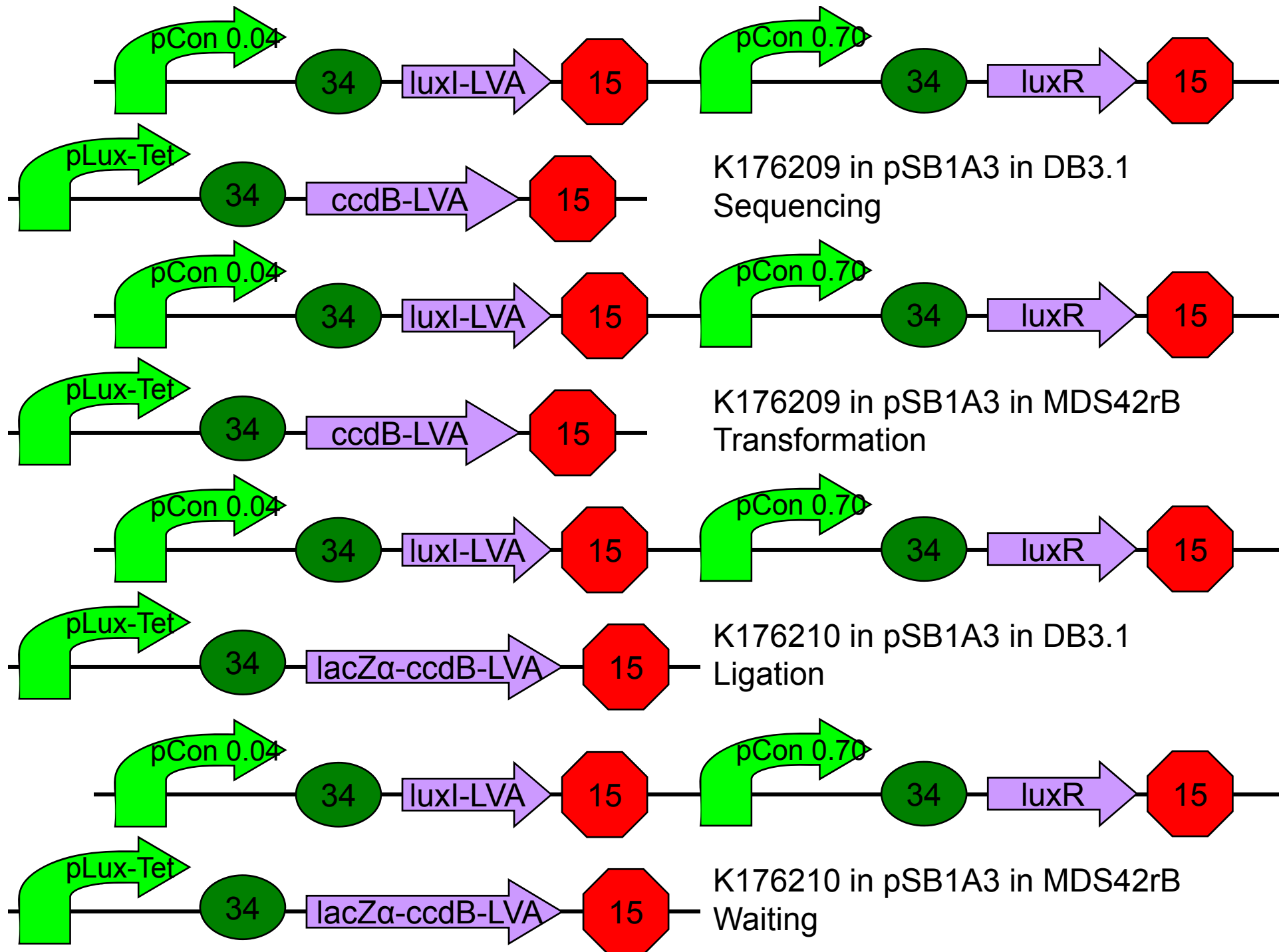

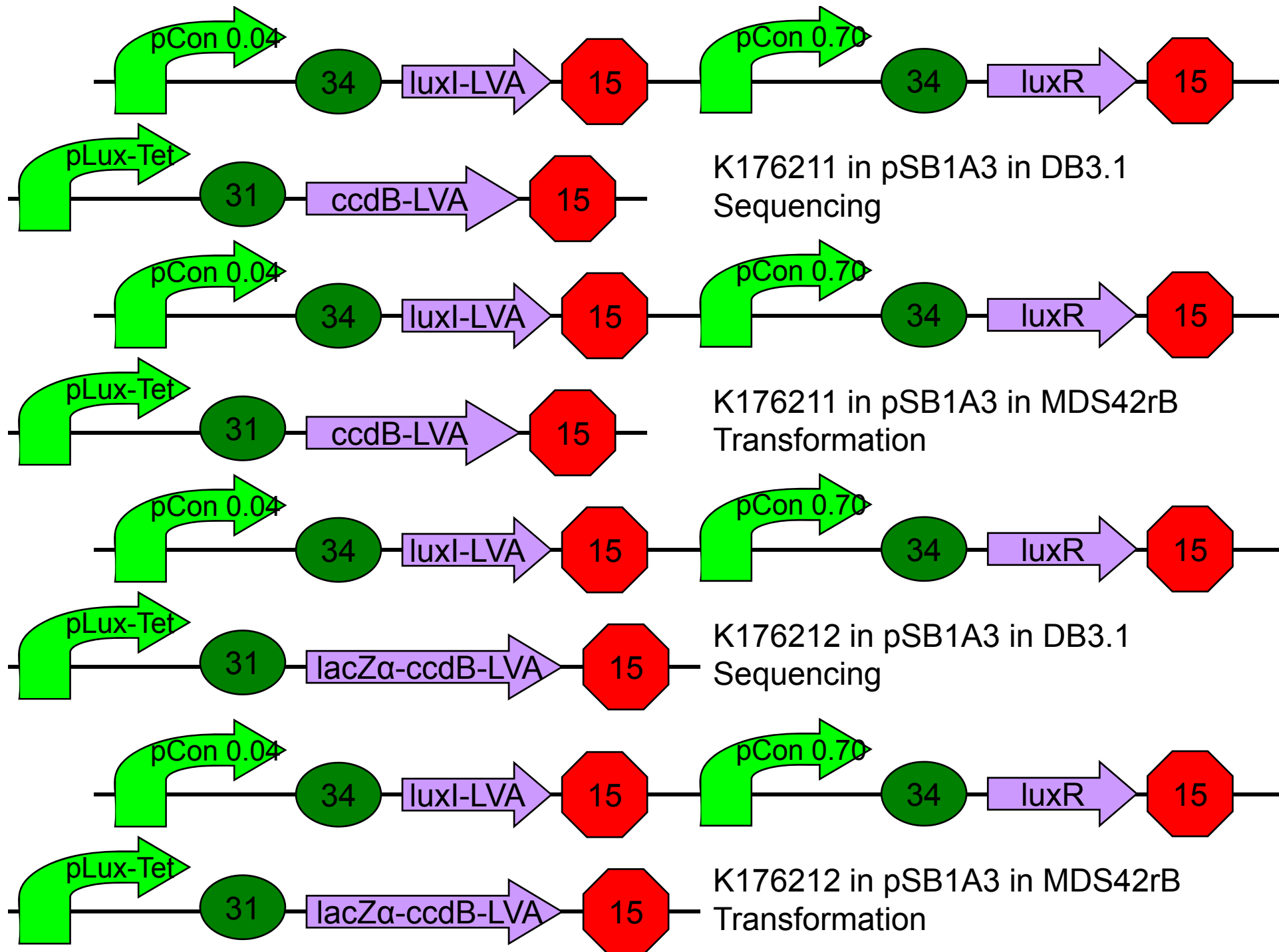

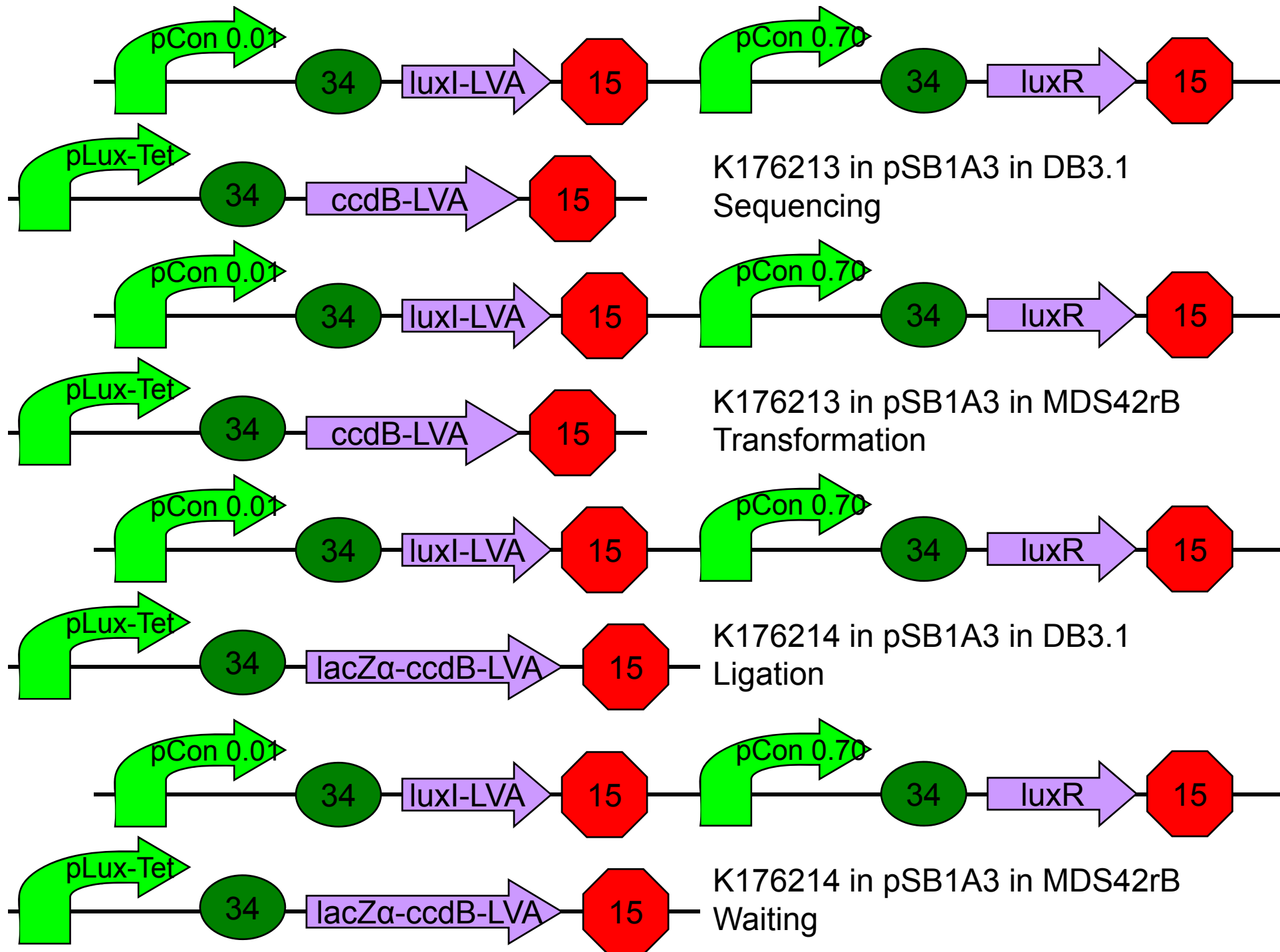

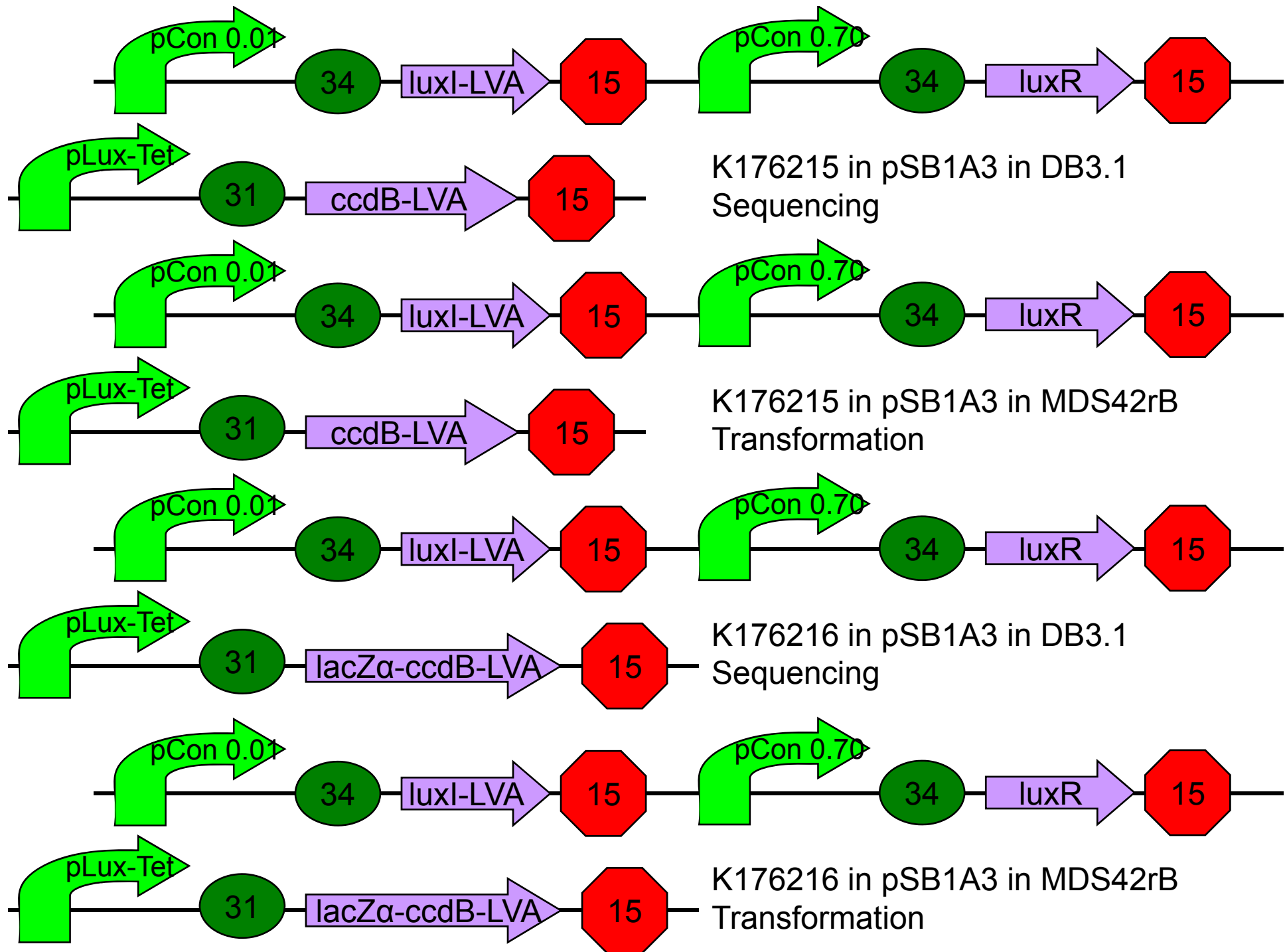

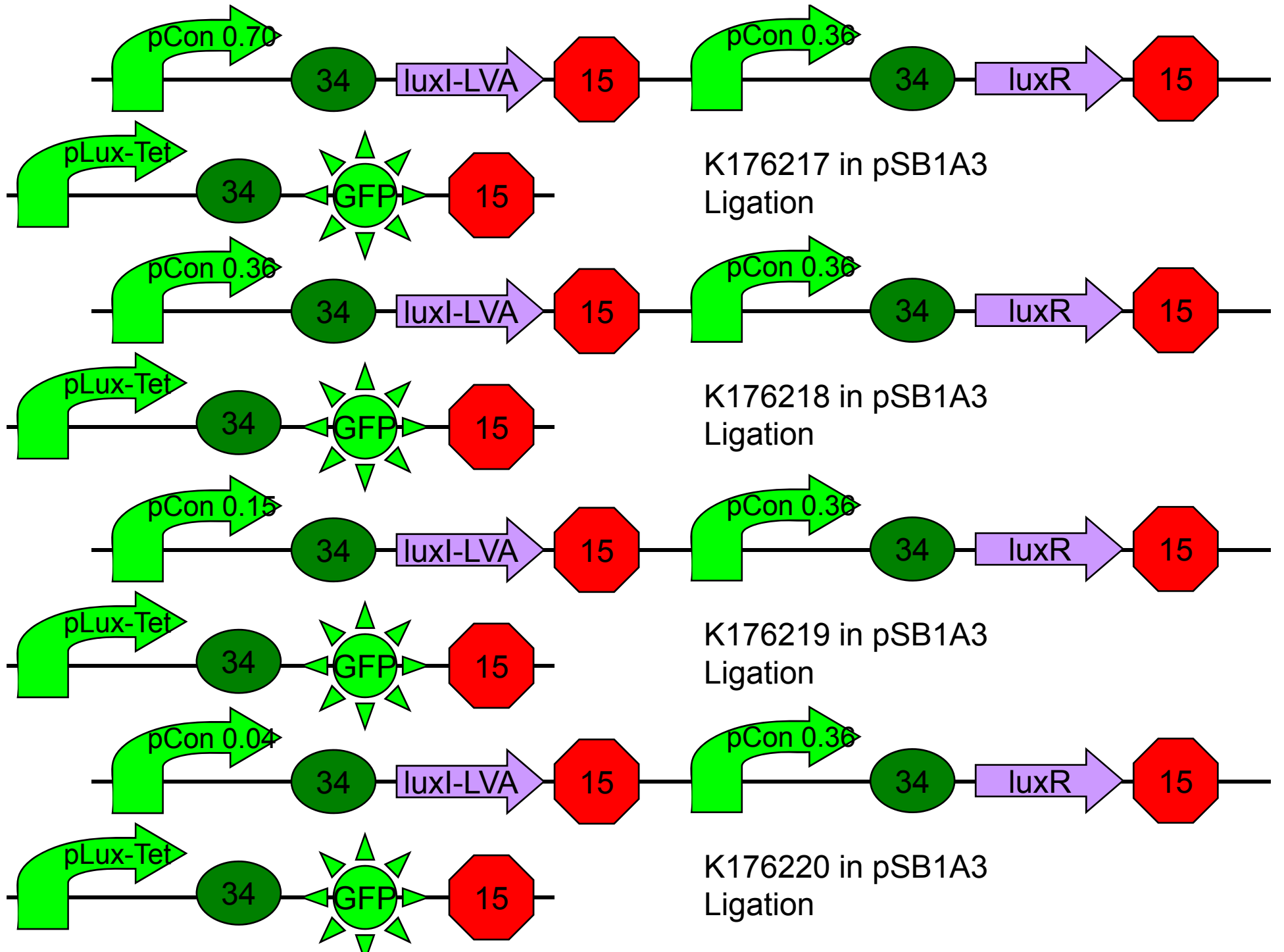

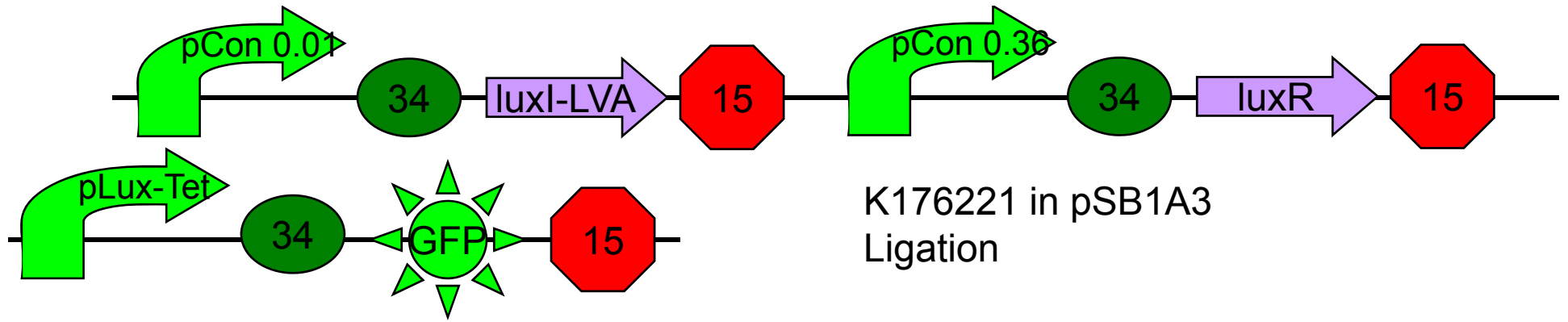

luxI+luxR+GFP

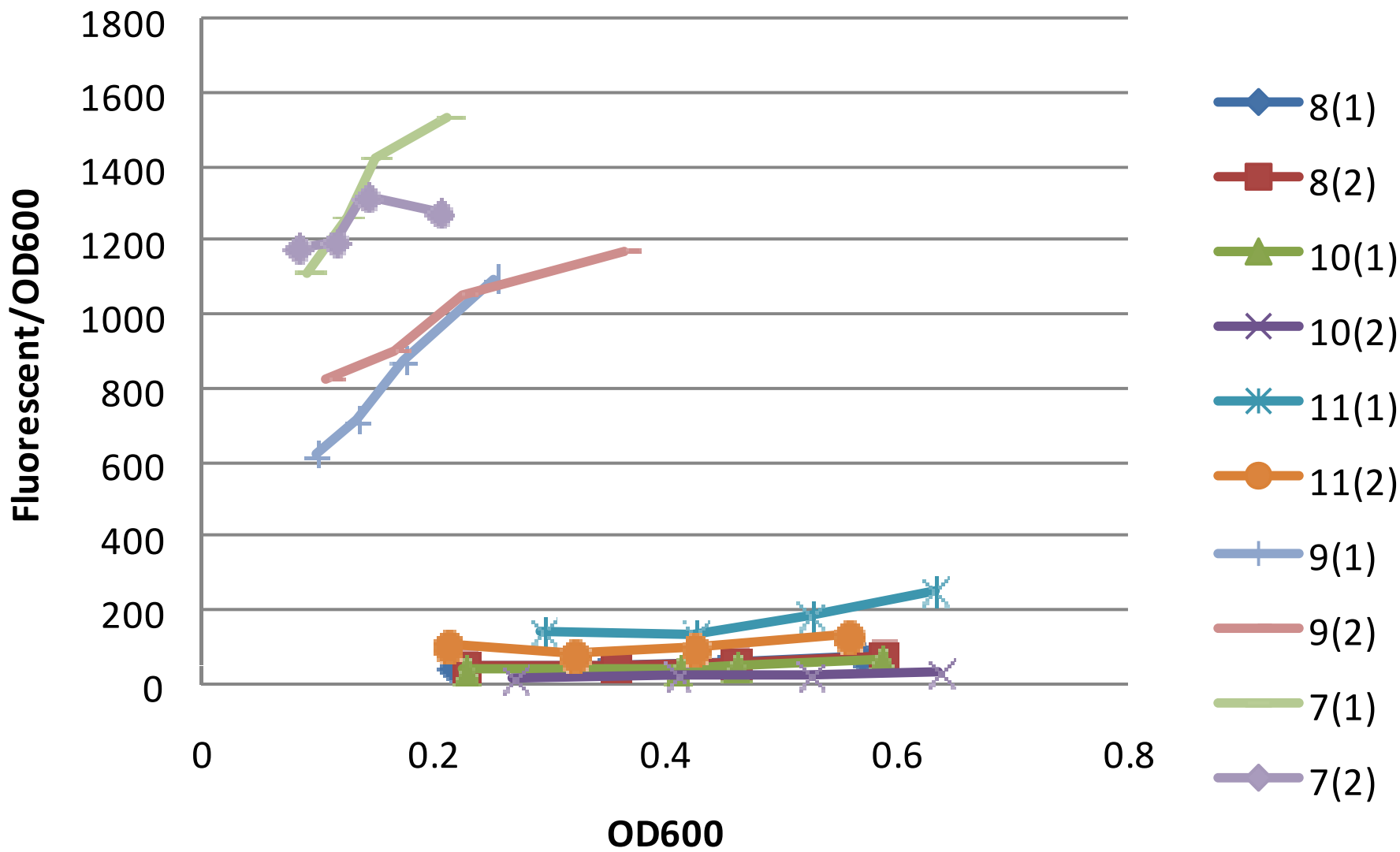



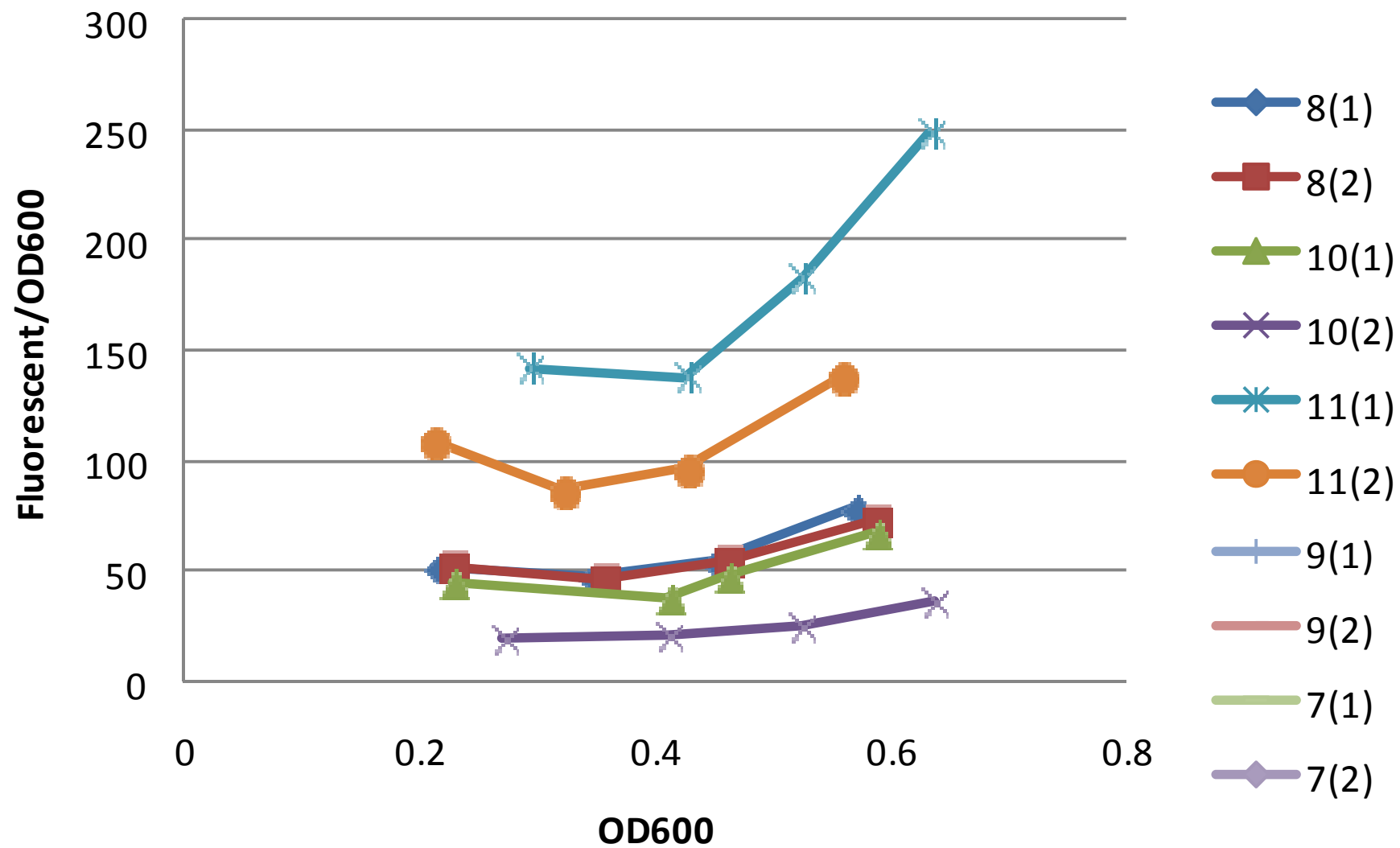



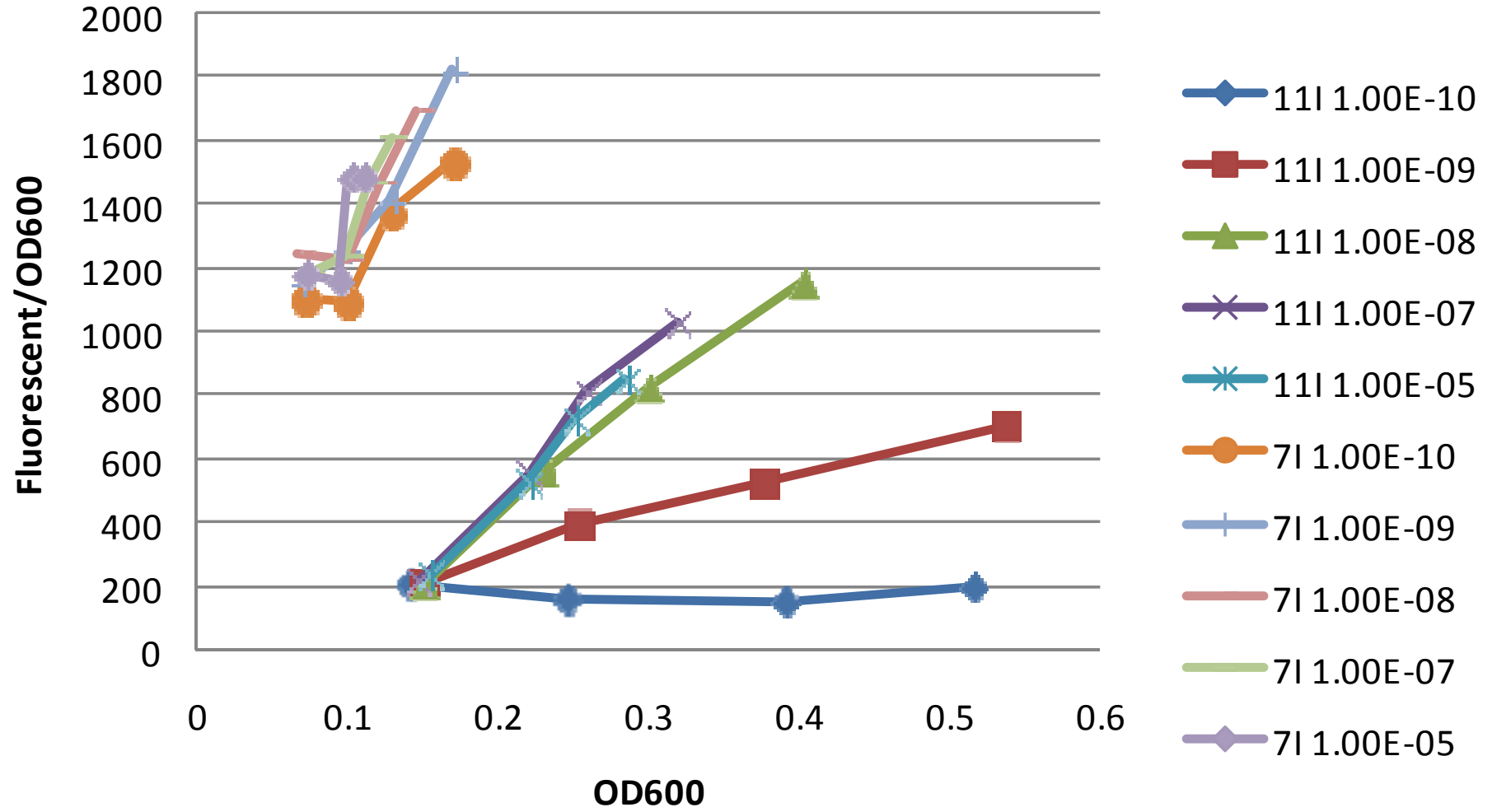

























luxI+luxR+GFP



luxI+luxR+GFP AHL



15

	K176037 E+S Synthesis OK		K176037 in pSB1A3 Sequence OK		K176047 Synthesis OK
	K176038 E+S Synthesis OK		K176038 in pSB1A3 Sequence OK		K176048 Synthesis OK
	K176039 E+S Synthesis OK		K176039 in pSB1A3 Sequence OK		K176049 Synthesis OK
	K176040 E+S Synthesis OK		K176040 in pSB1A3 Sequence OK		K176050 Synthesis OK
	K176041 E+S Synthesis OK		K176041 in pSB1A3 Sequence OK		K176051 Synthesis OK
	K176042 E+S Synthesis OK		K176042 in pSB1A3 Sequencing		K176052 Synthesis OK
	K176043 E+S Synthesis OK		K176043 in pSB1A3 Sequence OK		K176053 Synthesis OK
	K176044 E+S Synthesis OK		K176044 in pSB1A3 Sequence OK		K176054 Synthesis OK
	K176045 E+S Synthesis OK		K176045 in pSB1A3 Sequence OK		K176055 Synthesis OK
	K176046 E+S Synthesis OK		K176046 in pSB1A3 Sequence OK		K176056 Synthesis OK
—	pSB1A3 E+S Length OK				

16

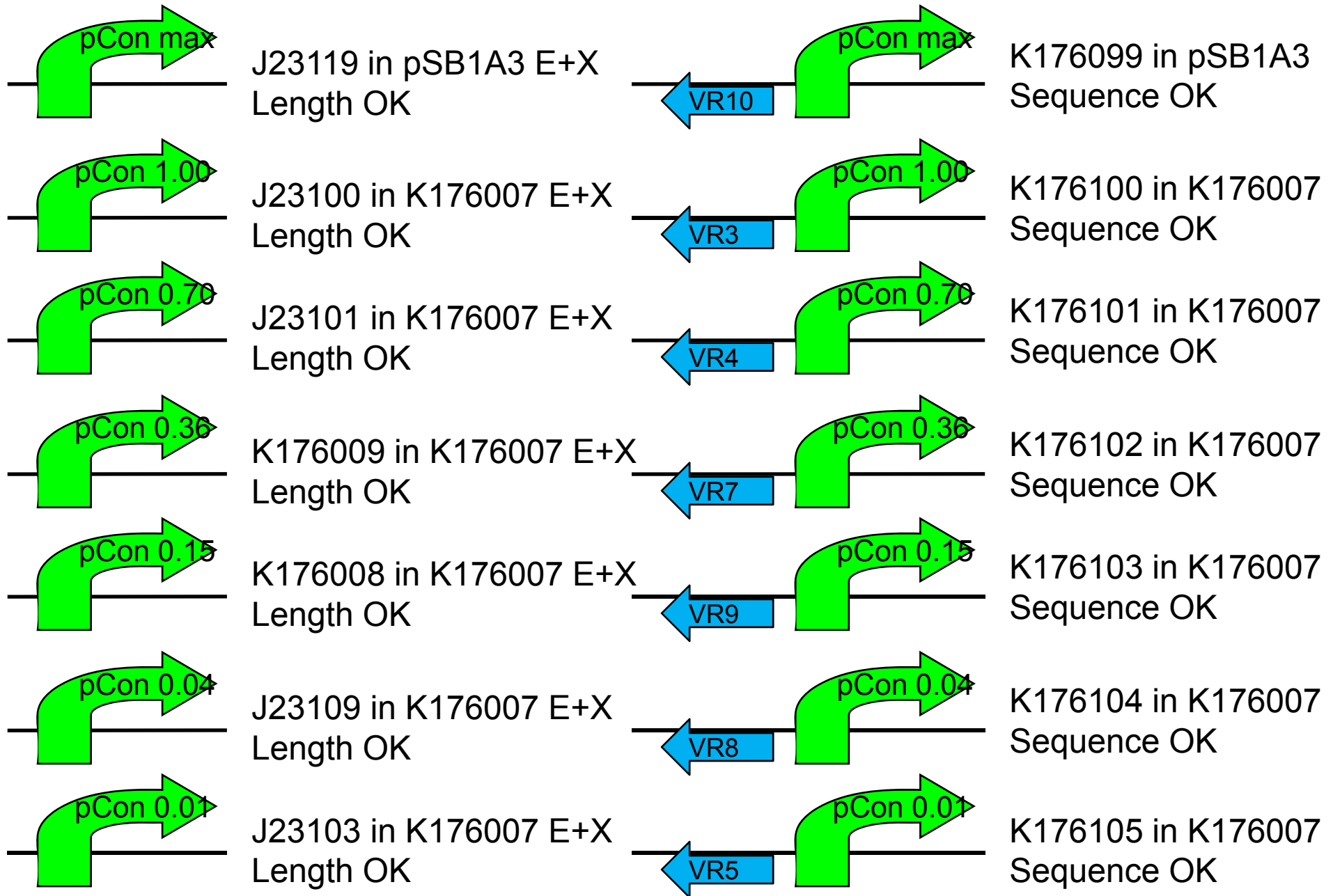

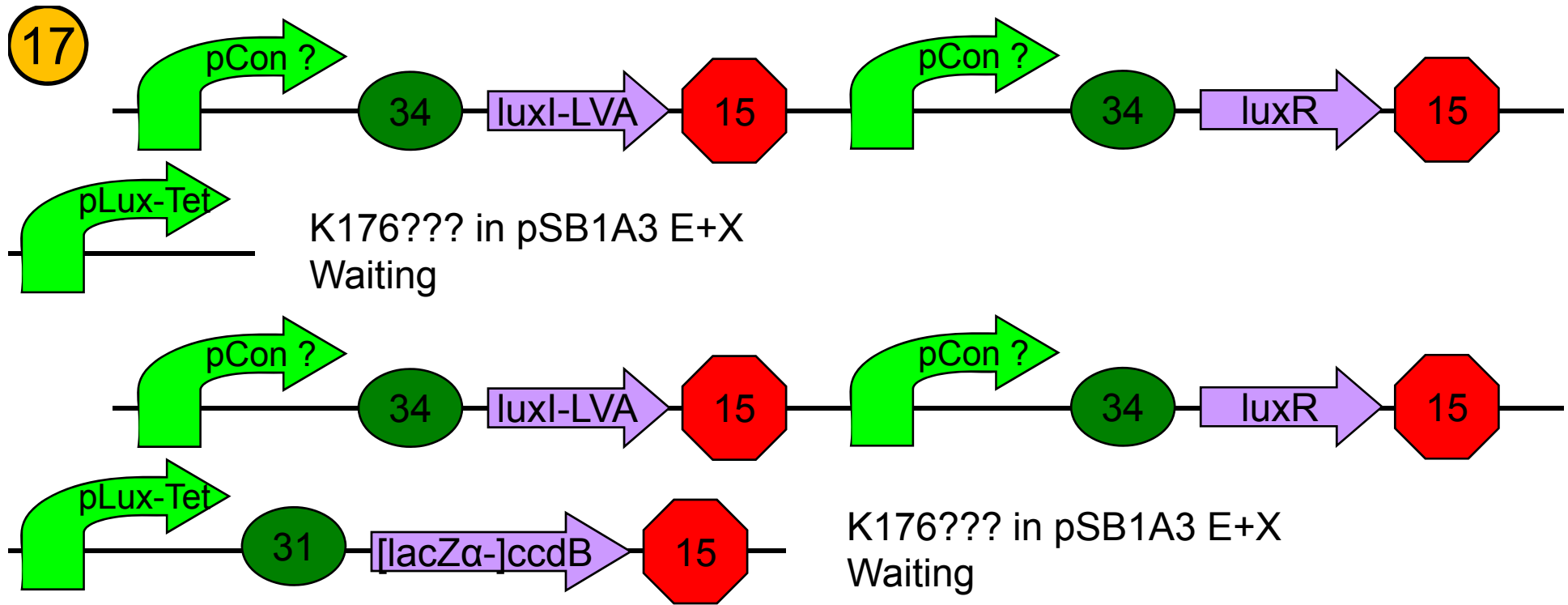

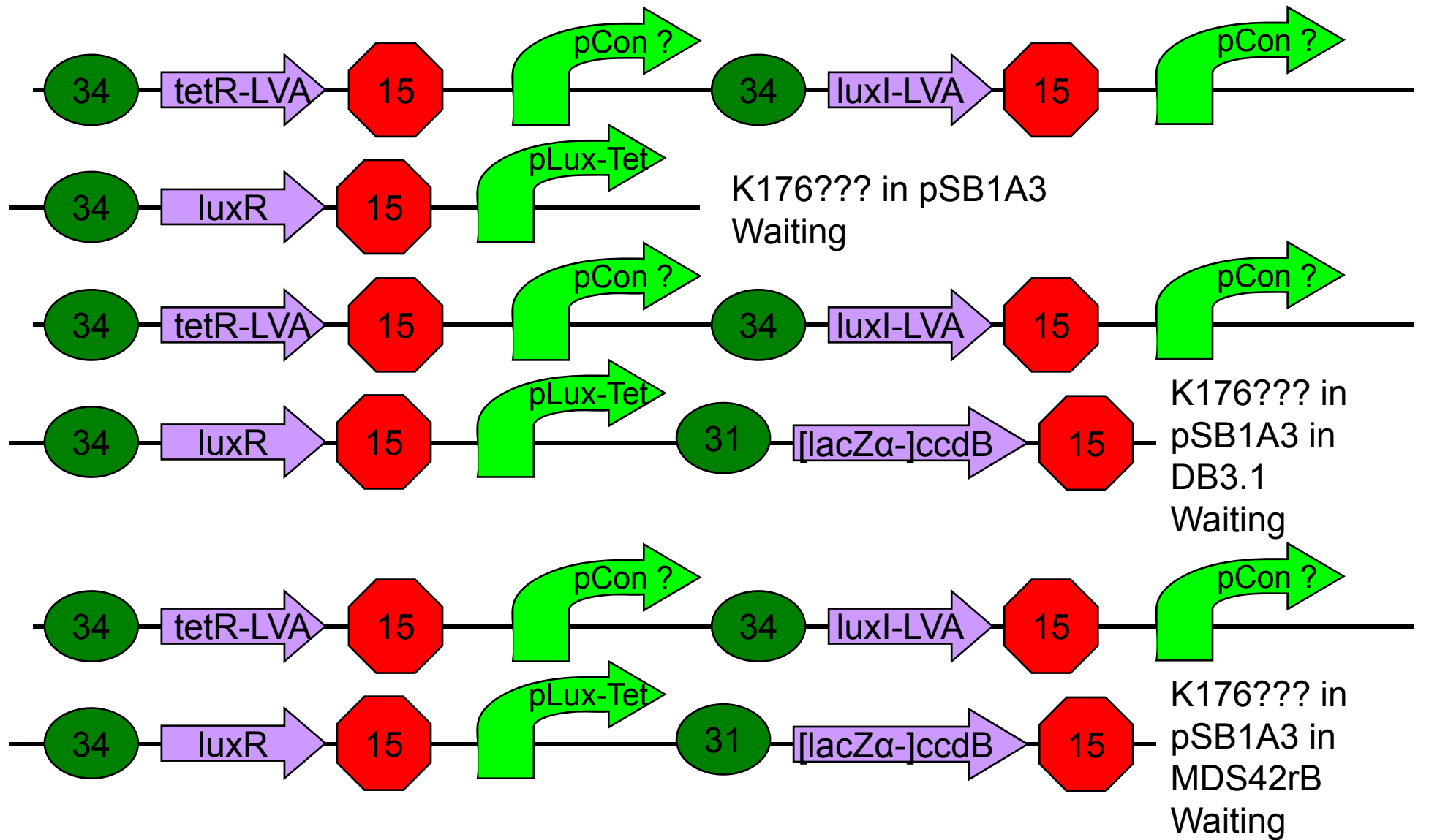

18

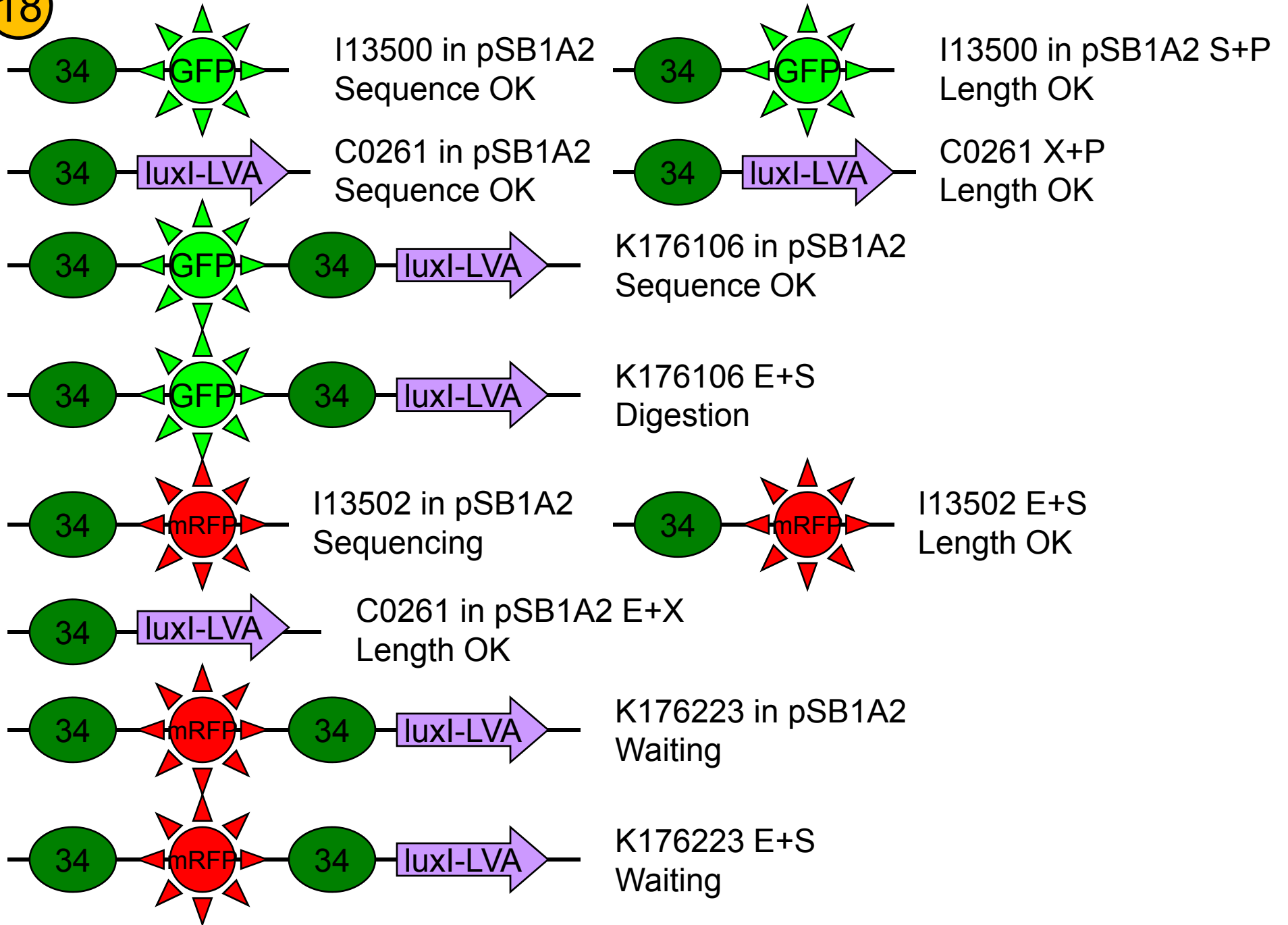

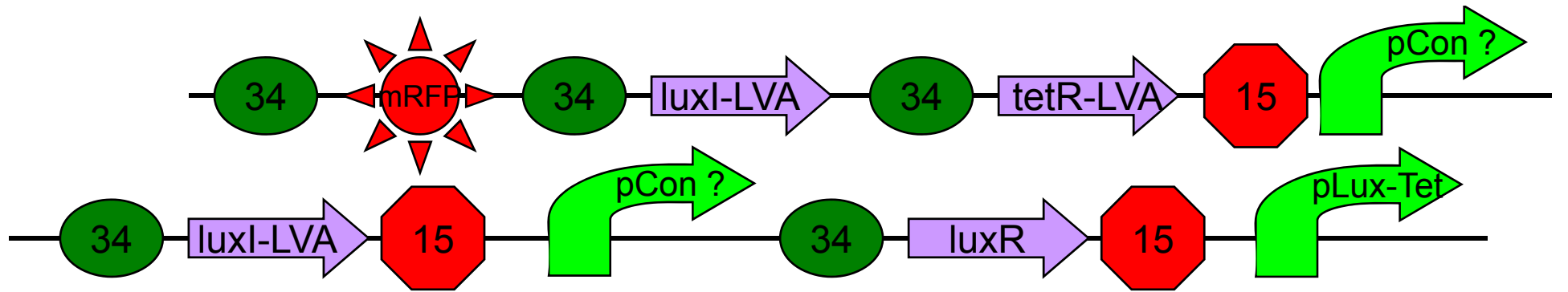

K176??? in pSB1A3
Waiting

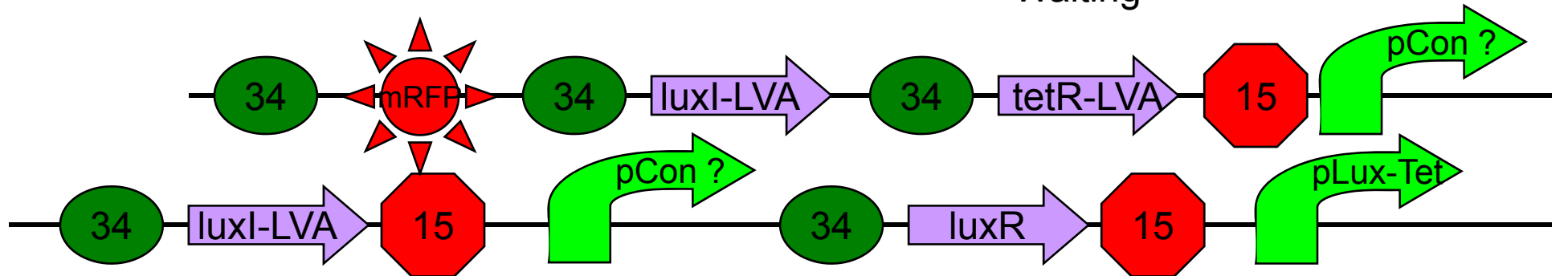

K176??? in pSB1A3 in DB3.1
Waiting

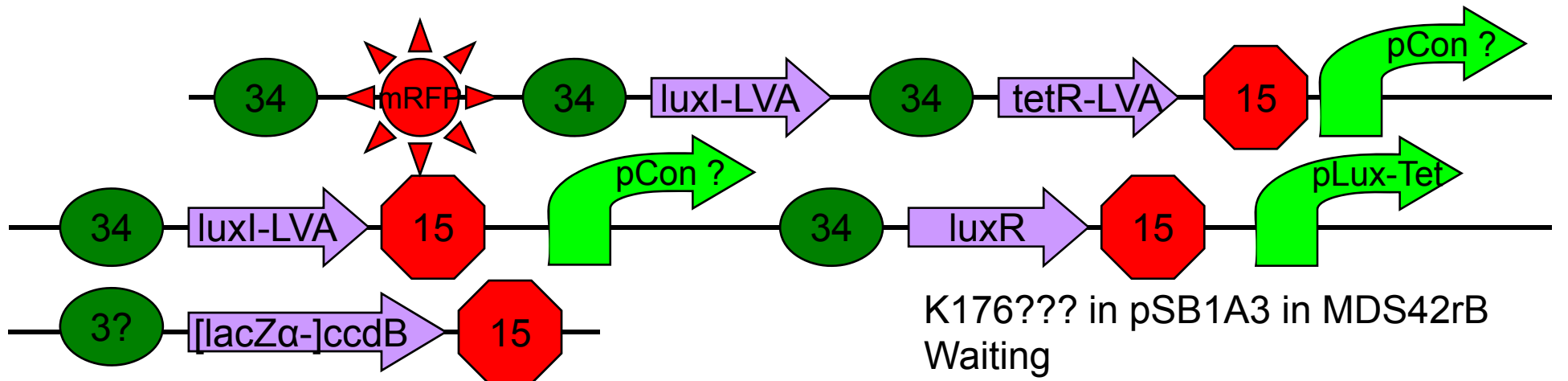

K176??? in pSB1A3 in MDS42rB
Waiting

19

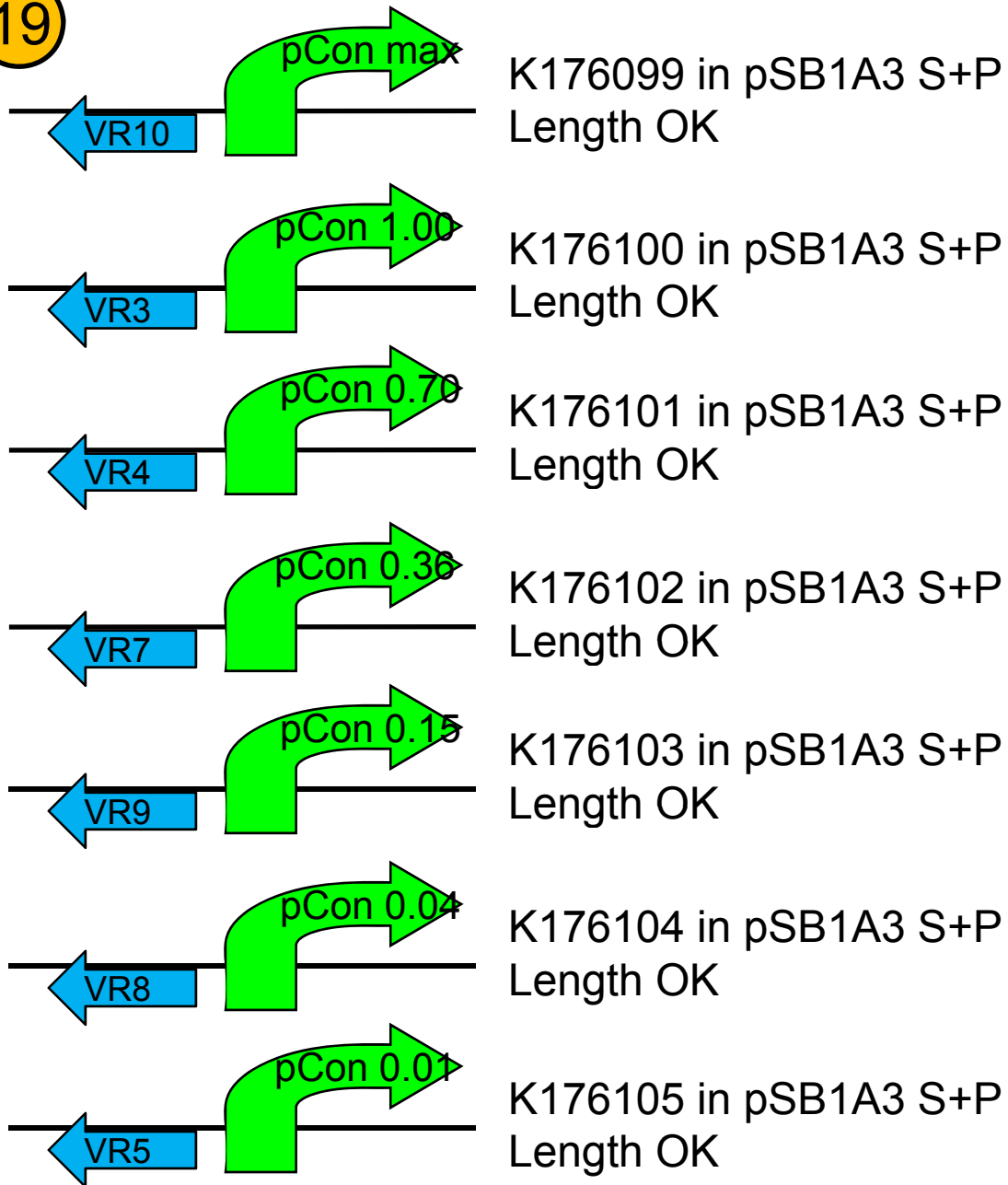

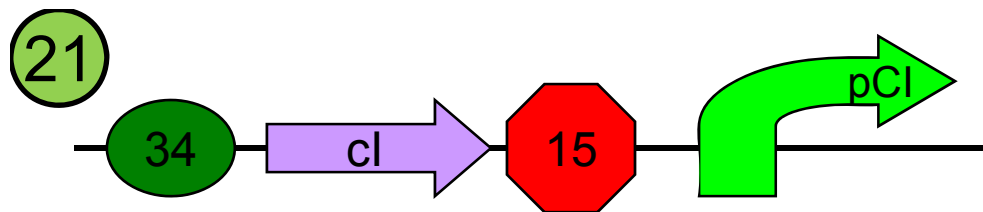

Q04510 in pSB2K3
Sequence OK

22

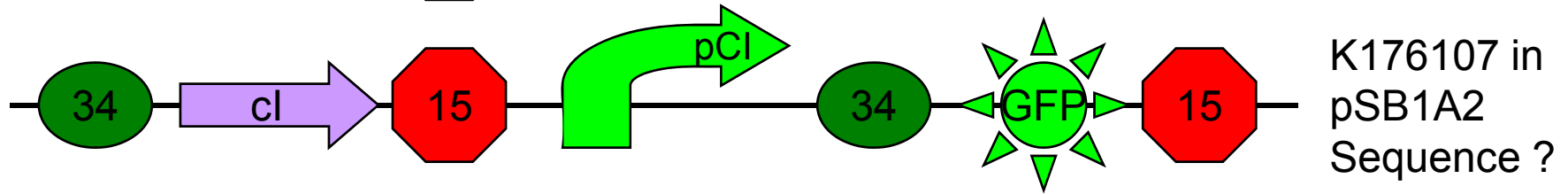
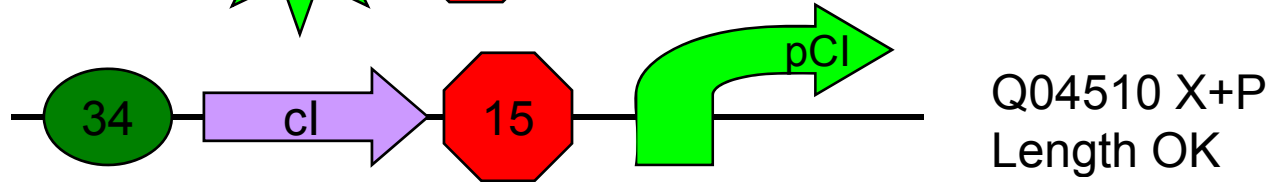
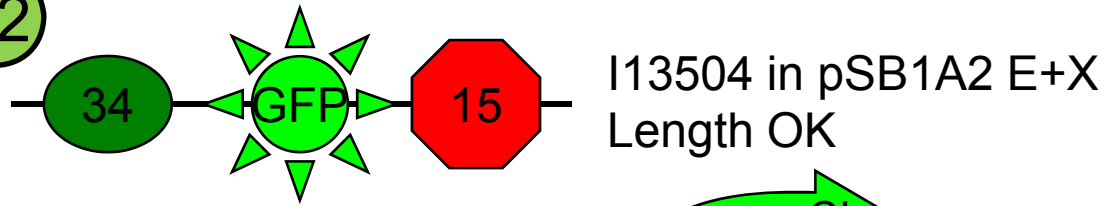

23

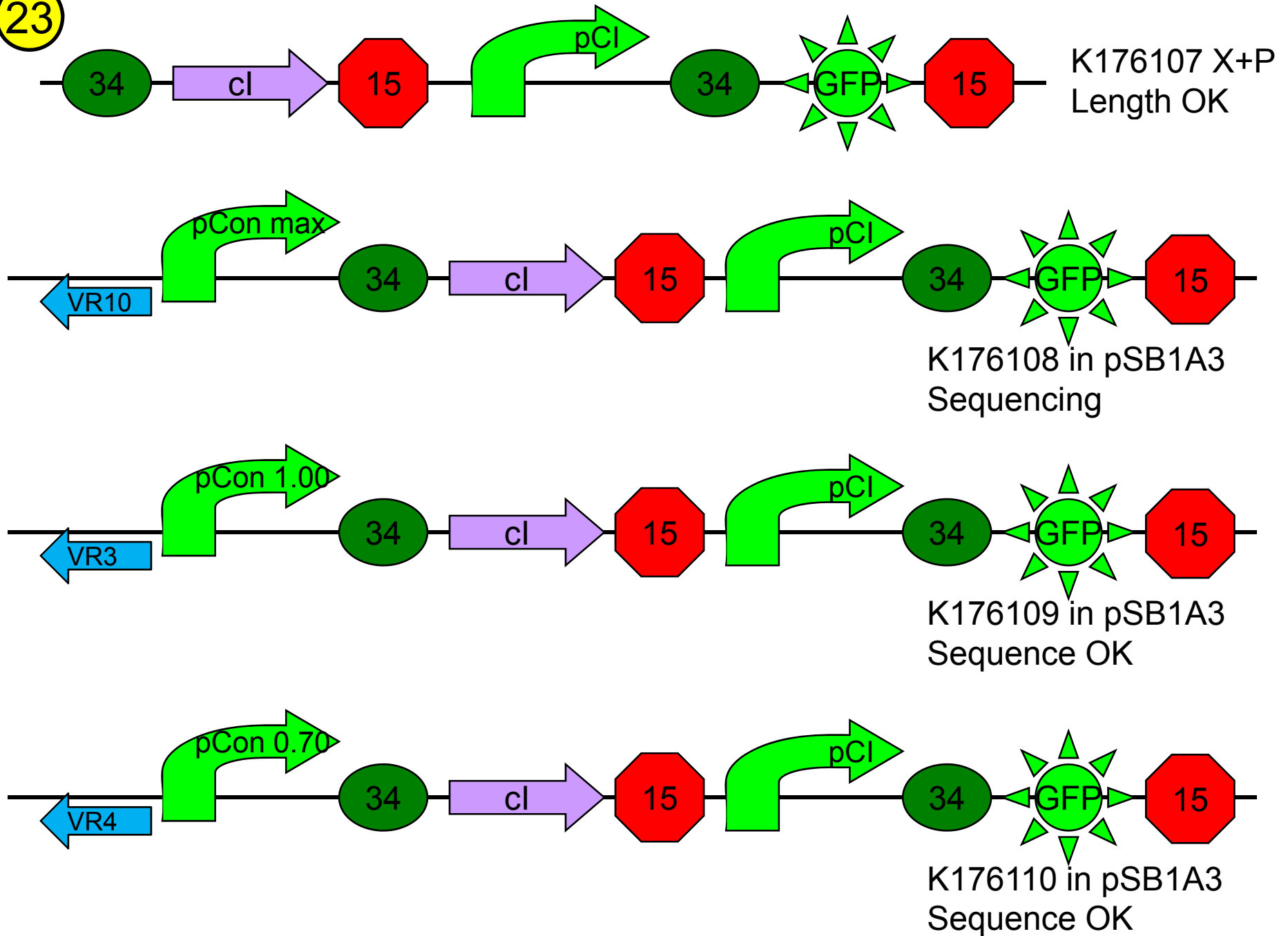

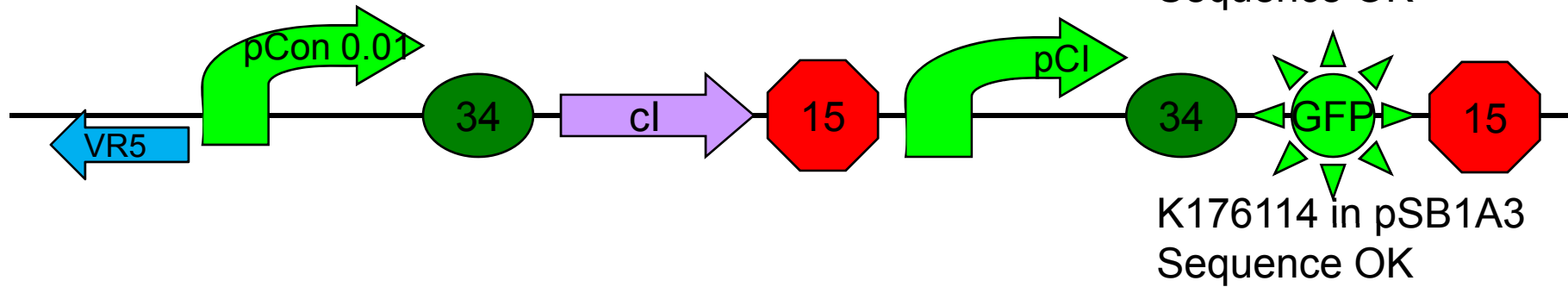
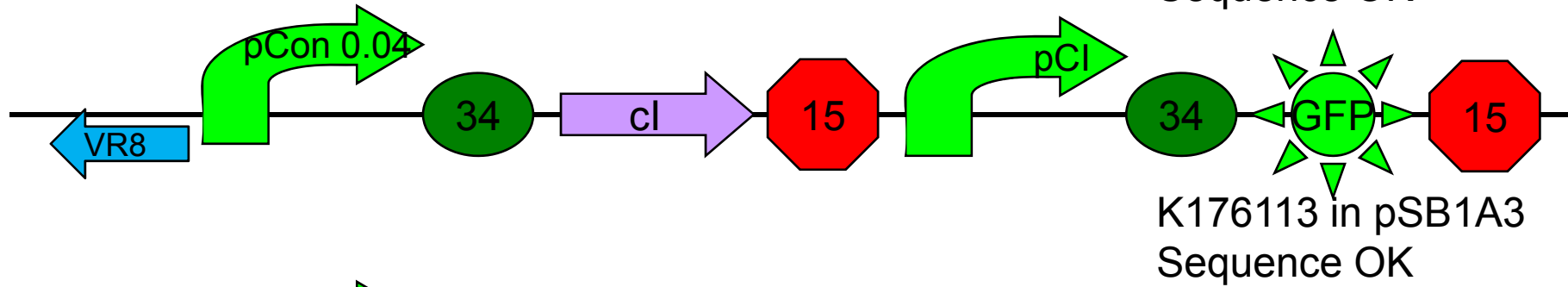
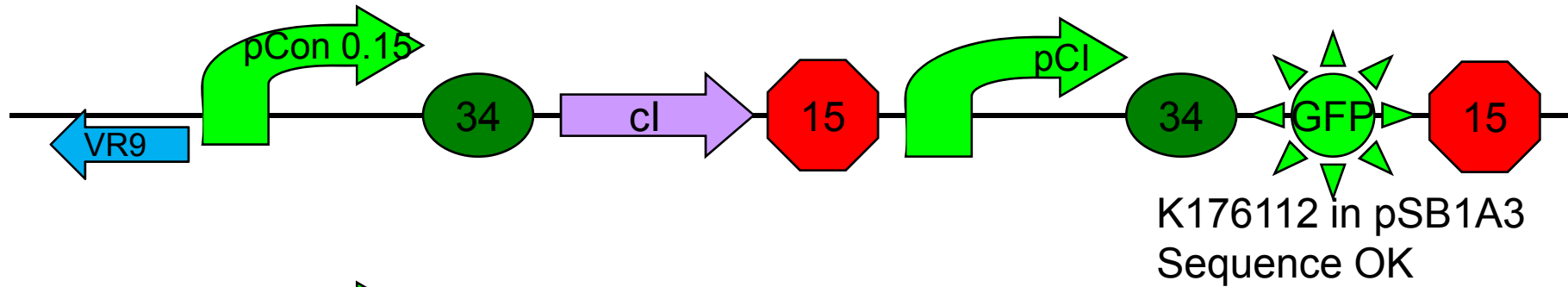
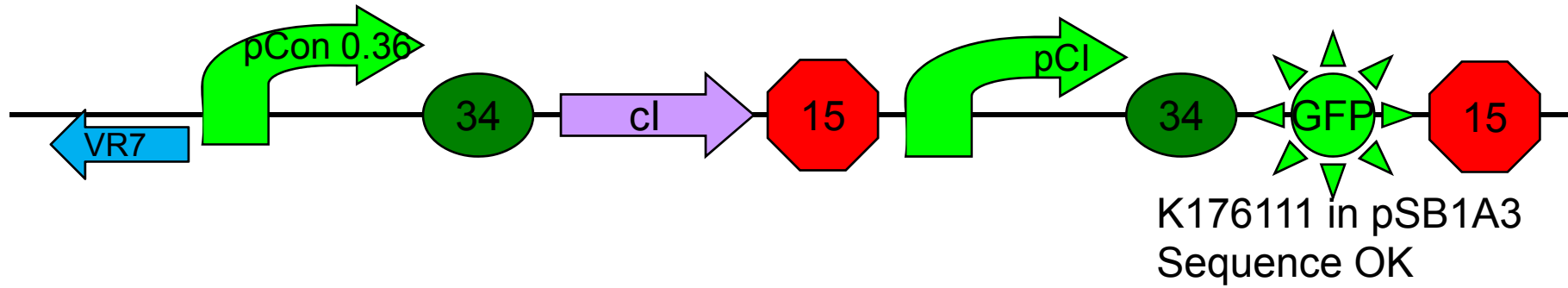

MDS42 recA Blue

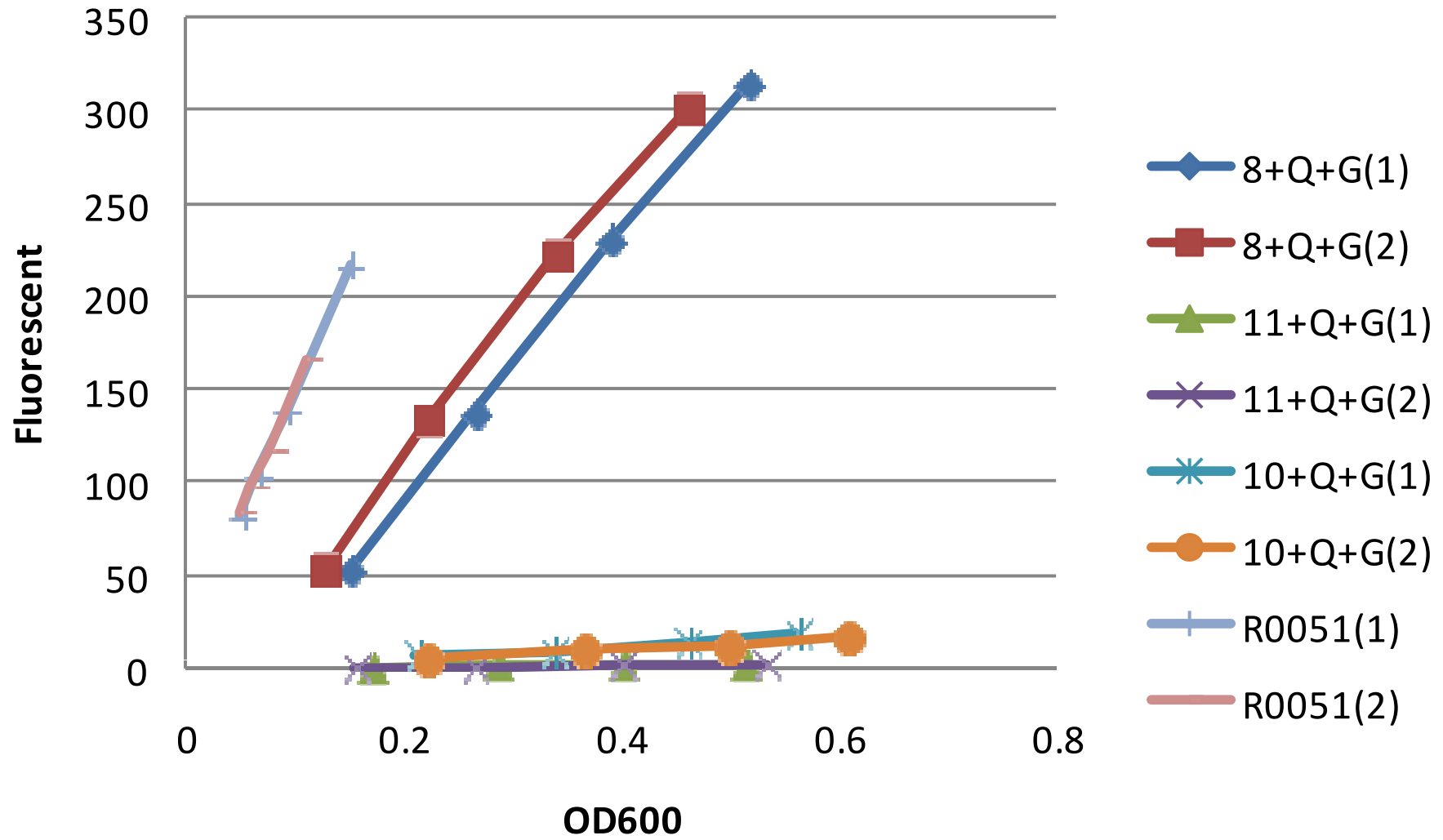

Transfer Function

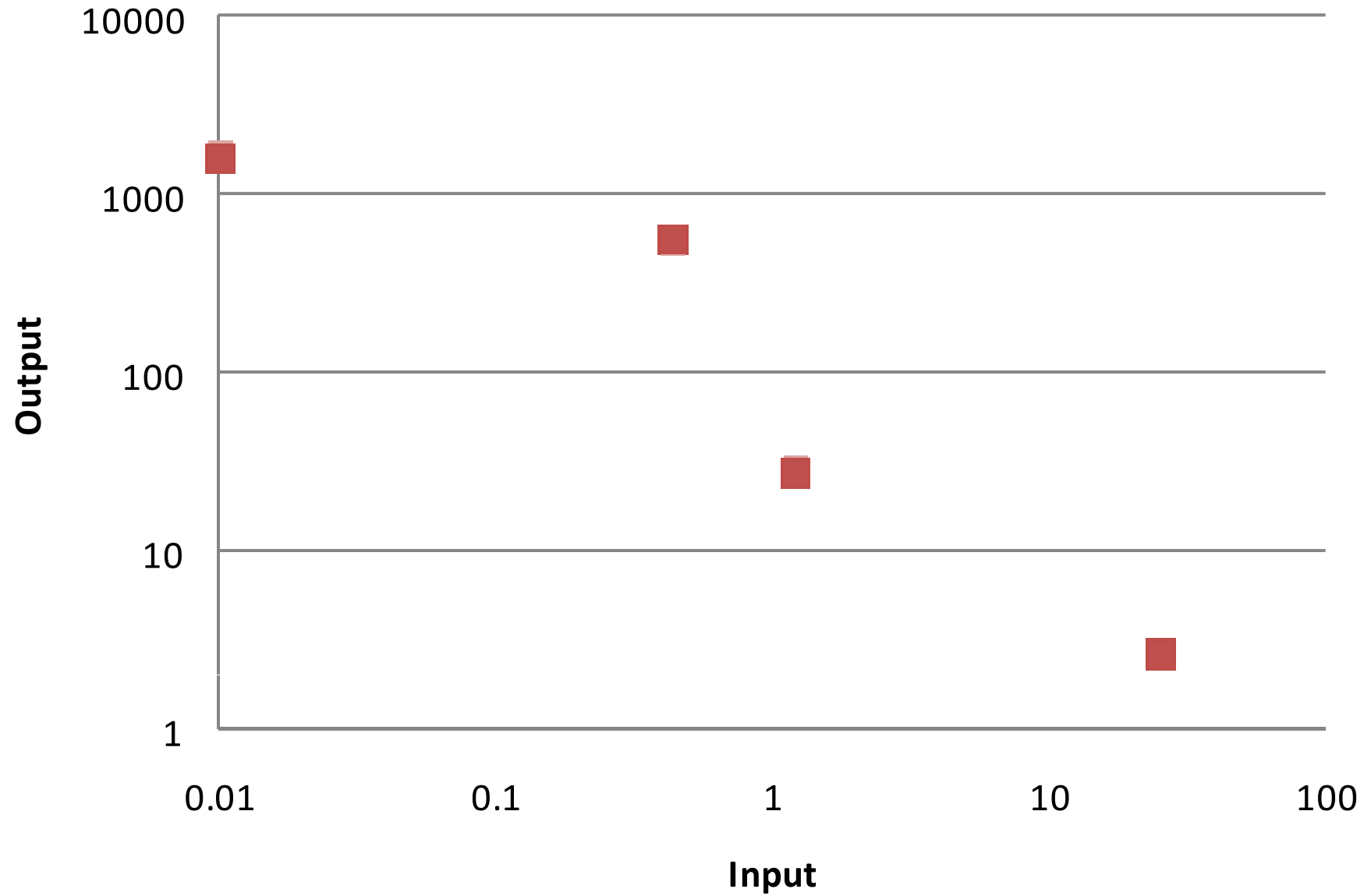

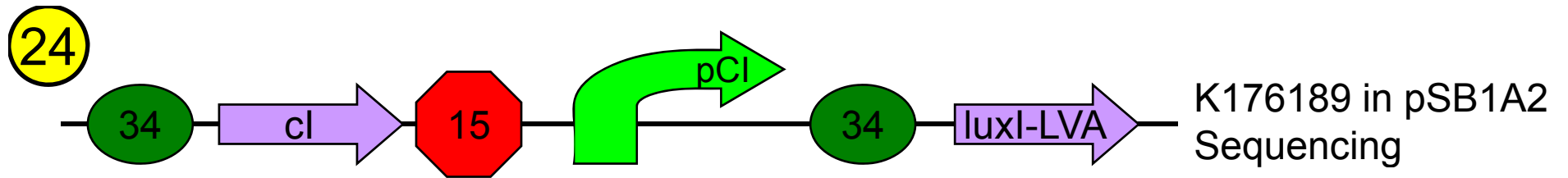

25



K103001 in pSB1A2
Sequencing



K176190 fragment
PCR



K176190 X+P
Length OK



K176190 in pSB1A3
Sequencing

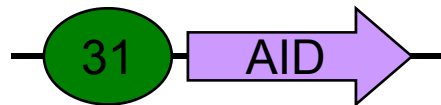

K176191 in pSB1A2
Sequencing

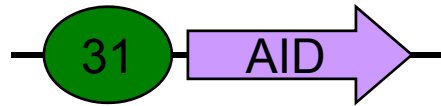

K176191 E+S
Length OK

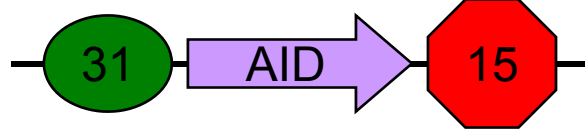

K176222 in pSB1AK3
Sequencing

26

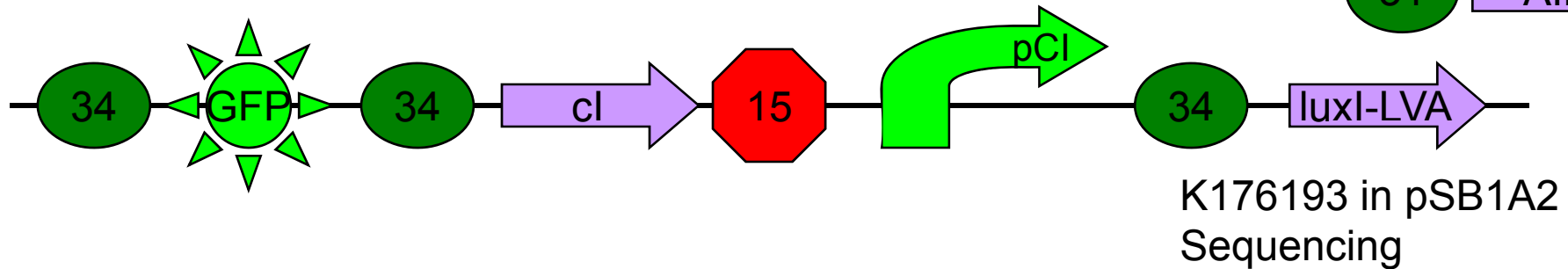
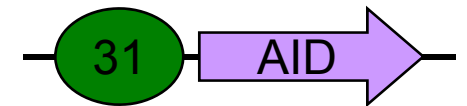
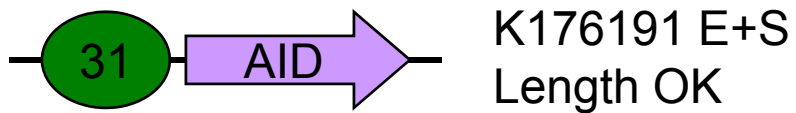
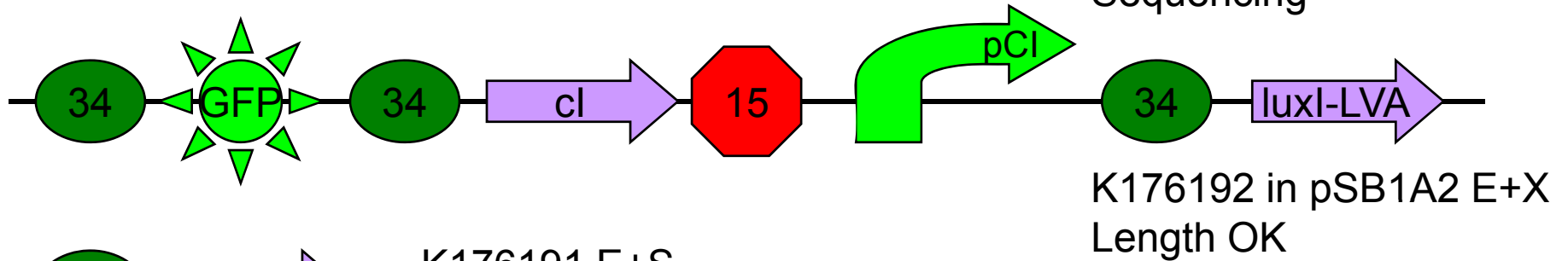
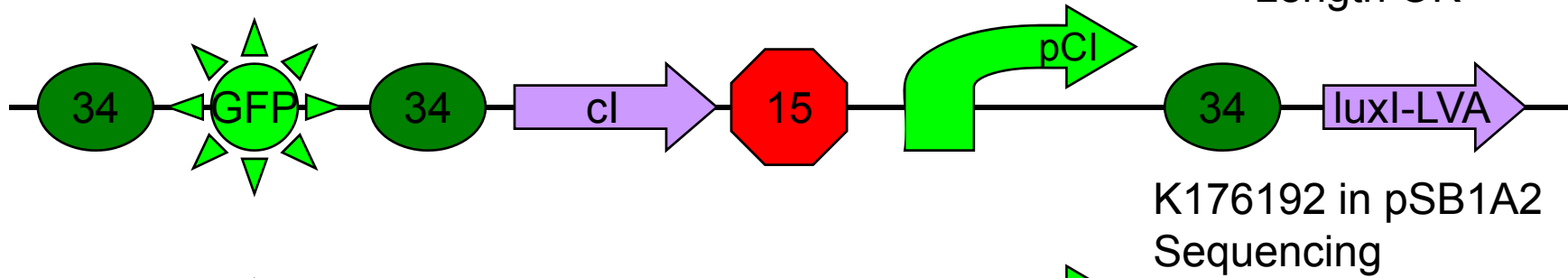
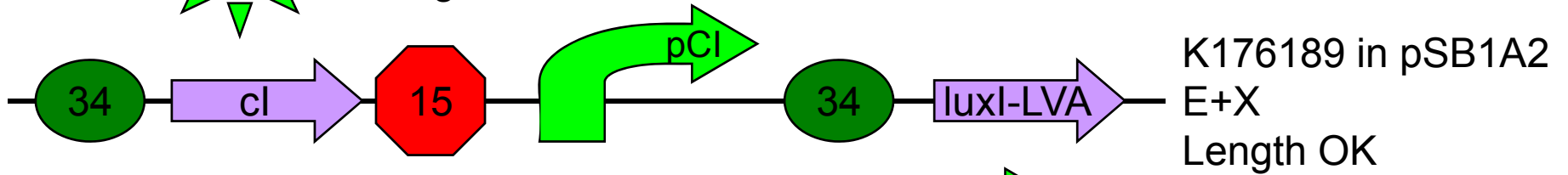
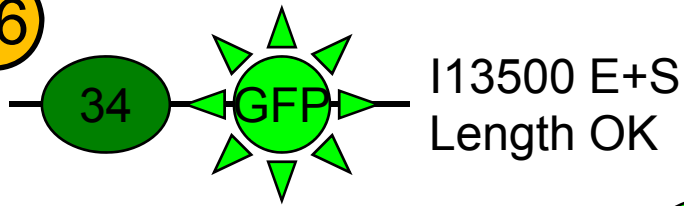

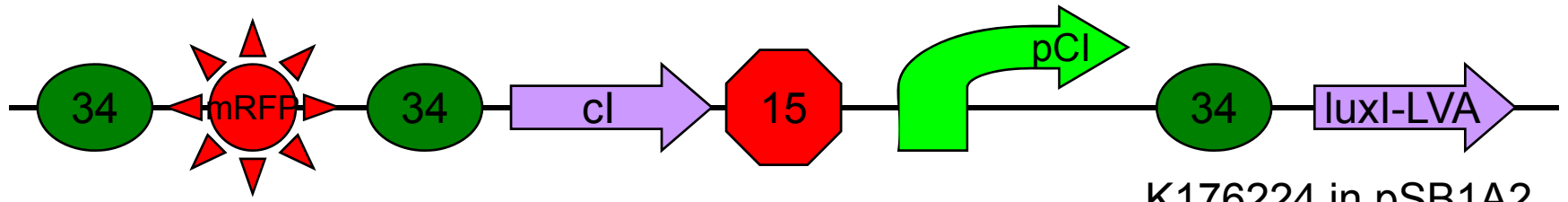

K176224 in pSB1A2
Ligation

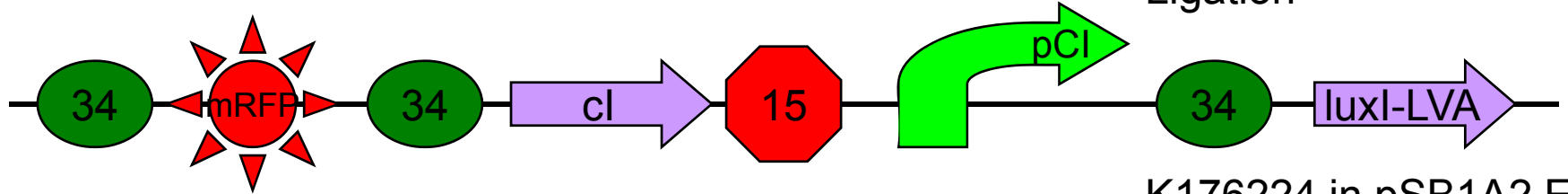

K176224 in pSB1A2 E+X
Waiting

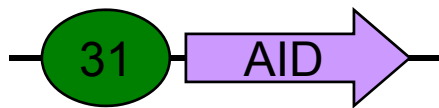

K176191 E+S
Length OK

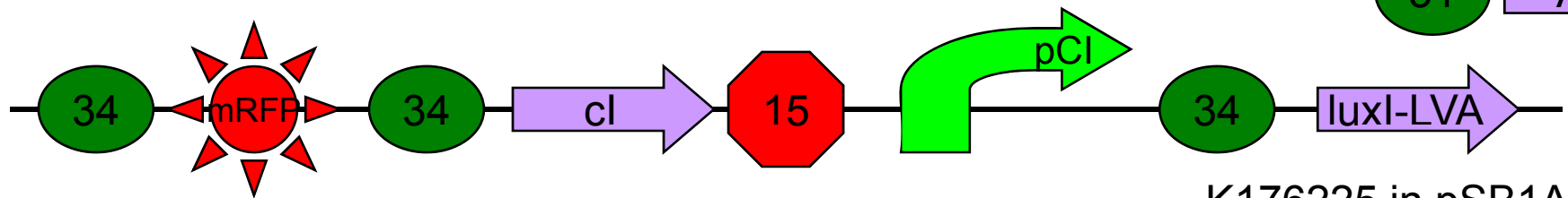

K176225 in pSB1A2
Waiting

Measurement

- Strain
 - TOP10
 - DH5 α
 - MG1655
 - MDS 42 recA Blue
- Plasmid
- Medium
 - LB
 - M9
 - Minimal
 - Supplemented
 - EZ Rich Define
 - pH-buffered TBK
 - pH-buffered LBK
- pH
- Temperature
 - 37°C
 - 30°C
 - 34°C
- Pre-warm
- Shake
- Dilution
- Wash

Thank You