

**E.ADEM v0.0.5.1**

**2009.8.15**

2009.5.3

103 days

2009.8.15

75 days

2009.10.30

# Outline

- Assembly
- Measurement
  - General Conditions
  - GFP
  - AHL
  - CcdB
  - LacZ $\alpha$
- Wiki
  - Team project description
  - Notebook
- Instructional Videos

# Assembly

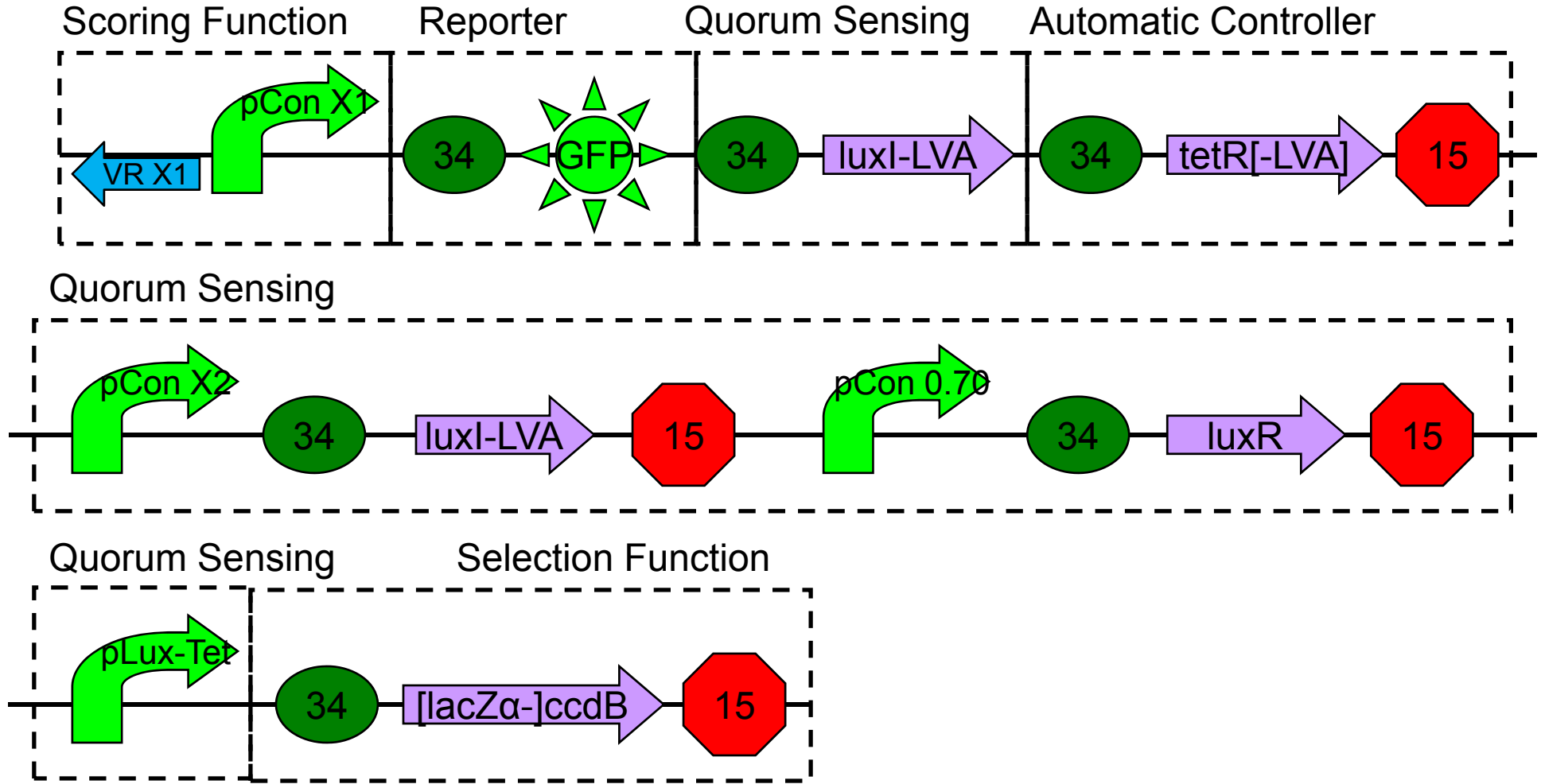

1. pLux-Tet
2. pLux-Tet + GFP
3. pCon + luxR + pLux-Tet
4. ccdB × 4
5. pCon × 8
6. pCon × 8 + GFP
7. pCon + luxR
8. pCon × 7 + luxI (AHL detection by 9 or GC-MS ?)
9. pCon + luxR + pLux-Tet + GFP (AHL)
10. pCon + luxR + pLux-Tet + ccdB × 4 (AHL)
11. tetR × 2
12. tetR × 2 + pCon + luxR + pLux-Tet [+ GFP]
13. pCon × 4 + tetR × 2 + pCon + luxR + pLux-Tet [+ GFP] (AHL/aTc)
14. [pCon × 7 +] luxI + pCon + luxR + pLux-Tet [+ ccdB]
15. VR × 10
16. (VR + pCon) × 7
17. tetR + pCon + luxI + pCon + luxR + pLux-Tet [+ ccdB]
18. GFP + luxI + tetR + pCon + luxI + pCon + luxR + pLux-Tet [+ ccdB]
19. (VR + pCon) × 8 + tetR + pCon + luxI + pCon + luxR + pLux-Tet [+ ccdB]
20. (VR + pCon) × 8 + GFP + luxI + tetR + pCon + luxI + pCon + luxR + pLux-Tet [+ ccdB]

Waiting  
Working  
Done  
Sequenced

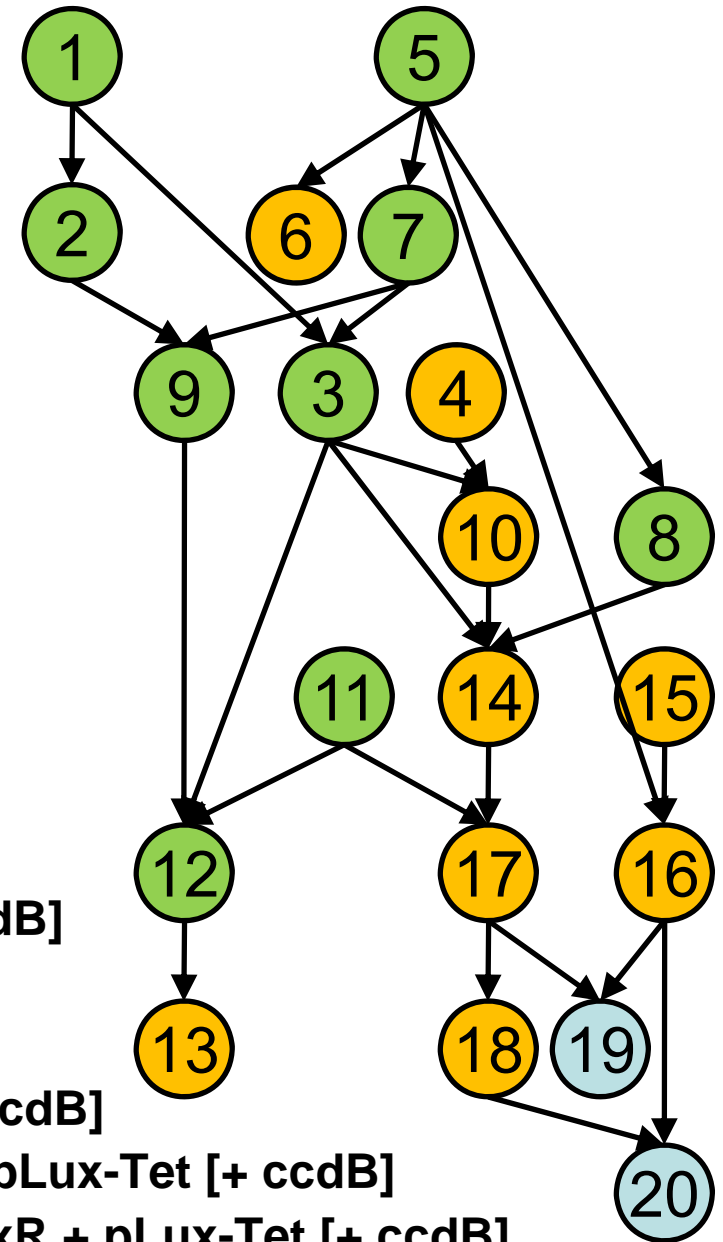

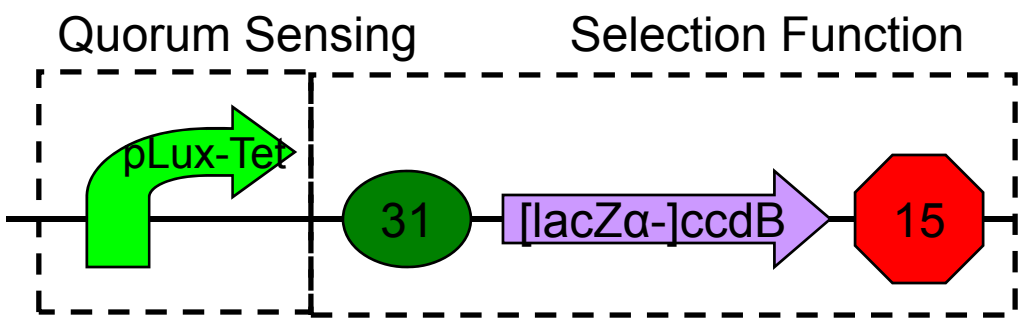
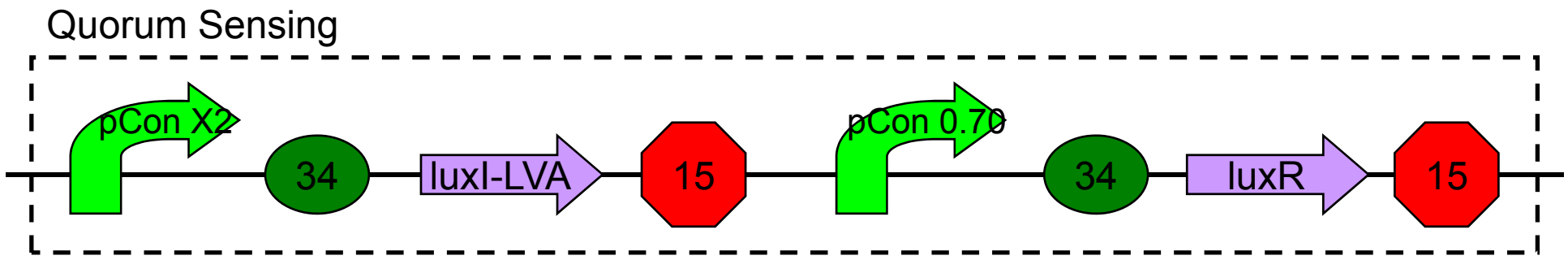
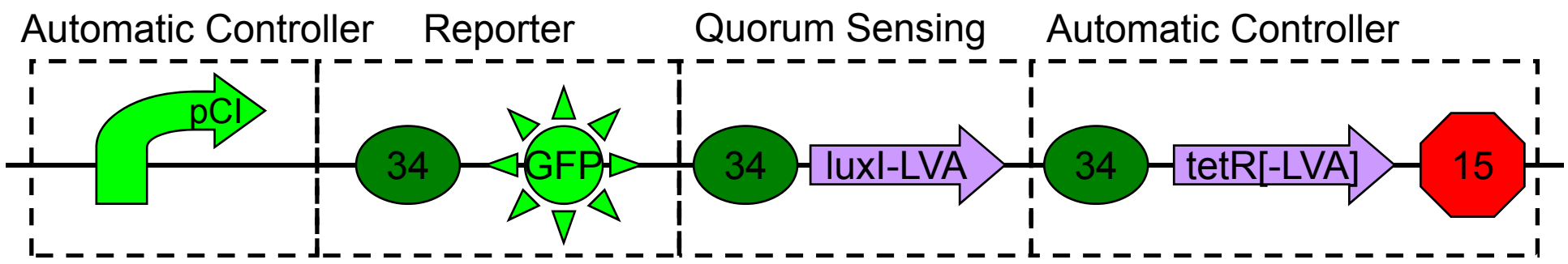
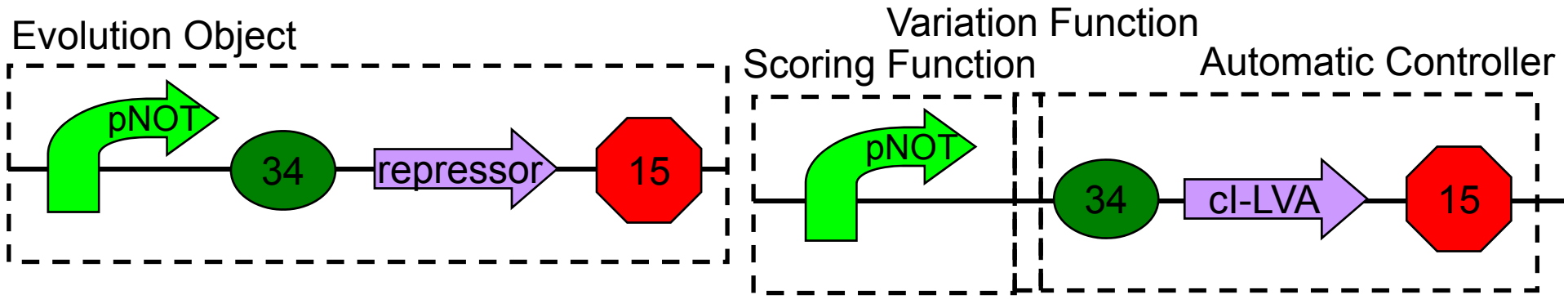

- 21.  $cl + pCI$
- 22.  $cl + pCI + GFP$
- 23.  $(VR + pCon) \times 7 + cl + pCI + GFP$
- 24.  $cl + pCI + GFP + luxI + tetR + pCon + luxI + pCon + luxR + pLux-Tet [+ ccdB]$
- 25.  $(VR + pCon) \times 7 + cl + pCI + GFP + luxI + tetR + pCon + luxI + pCon + luxR + pLux-Tet [+ ccdB]$
- 26. pNOT
- 27. pNOT + GFP
- 28.  $pNOT + cl + pCI + GFP + luxI + tetR + pCon + luxI + pCon + luxR + pLux-Tet [+ ccdB]$
- 29. repressor
- 30. pNOT + repressor

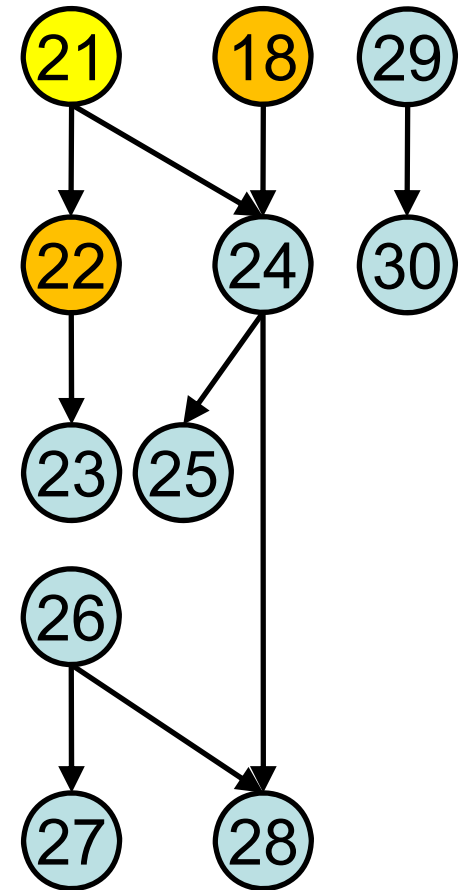

1

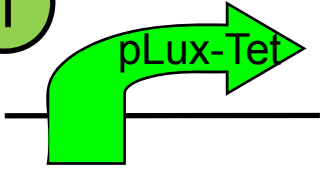

K176000 X+P with nicks  
Sequence OK



G00100  
Synthesis OK



G00101  
Synthesis OK

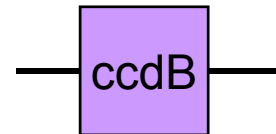

P1010 in pSB1A3 in DB 3.1  
Length OK



pSB1A3 X+P  
Length OK

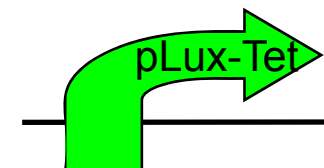

K176000 in pSB1A3  
Sequence OK



2

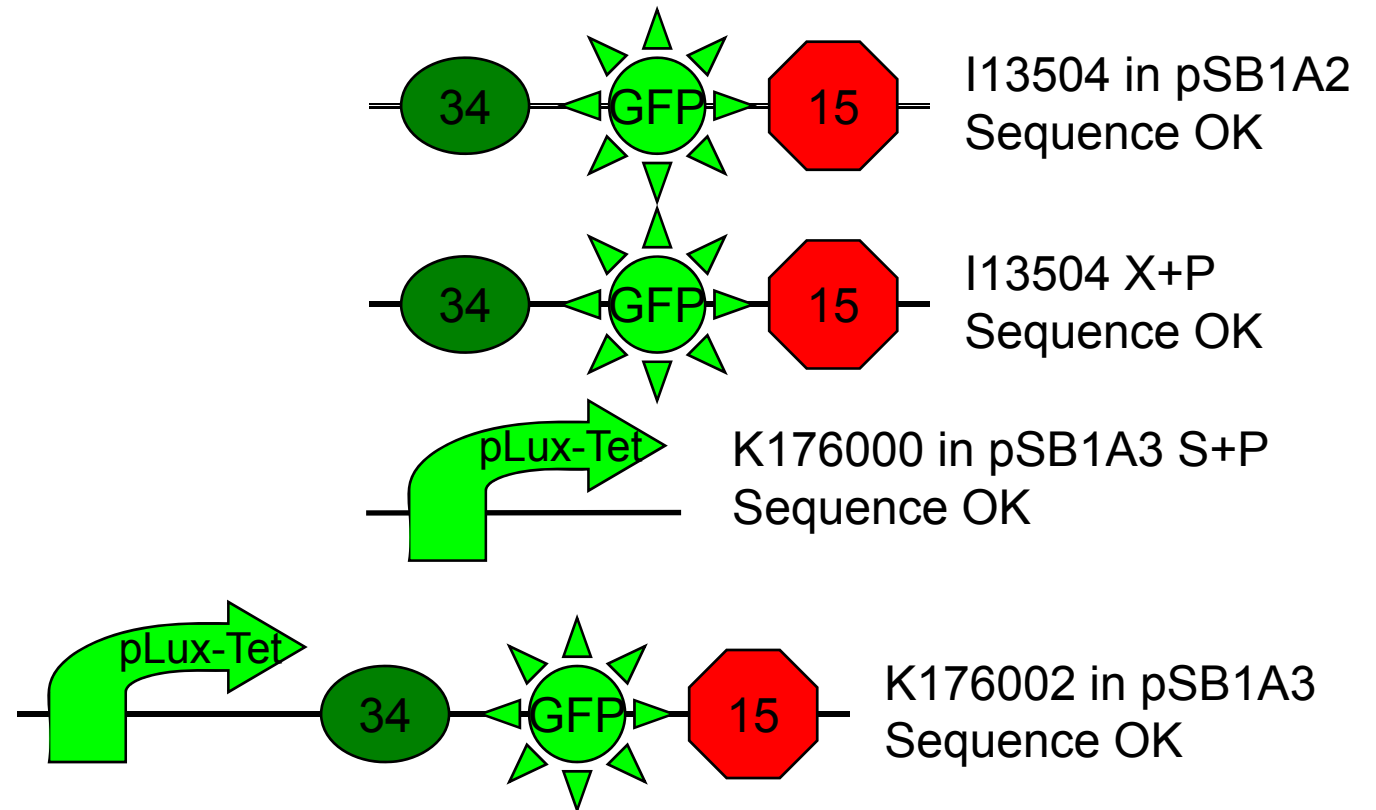

4



K145151 in pSB1A2 in DB3.1

Sequence OK

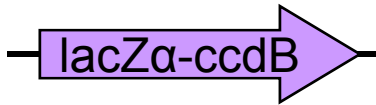

K176003 Fragment Length OK



B0034 in pSB1A2 Sequence OK



B0034 in pSB1A2 S+P Length OK



K145151 X+P Length OK

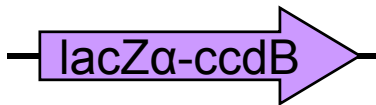

K176003 X+P Length OK

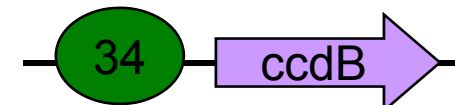

K176010 in pSB1A2 in DB3.1 Ligation

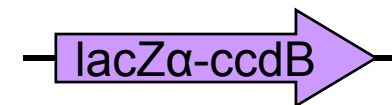

K176003 in pSB1A3 in DB3.1 Sequence OK

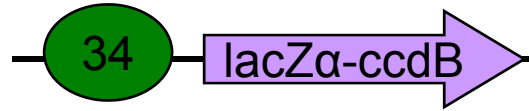

K176027 in pSB1A2 in DB3.1 Sequence OK

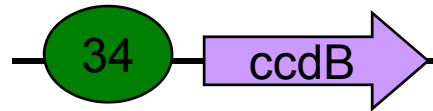

K176010 E+S Length OK

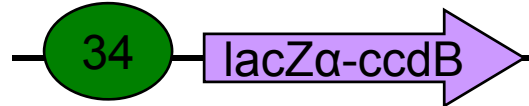

K176027 E+S Length OK

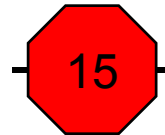

B0015 in pSB1AK3 Sequence OK



B0031 in pSB1A2 Length OK



B0031 S+P Length OK

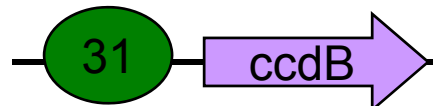

K176060 in pSB1A2 in DB3.1 Sequence OK

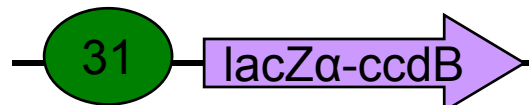

K176061 in pSB1A2 in DB3.1 Sequence OK

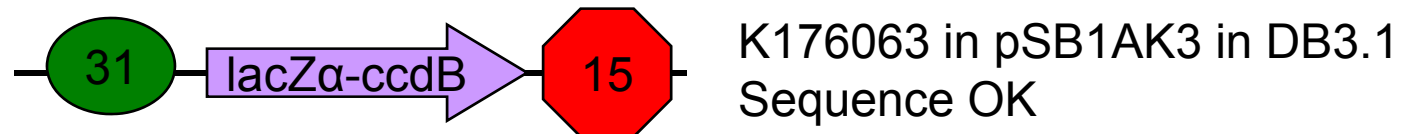
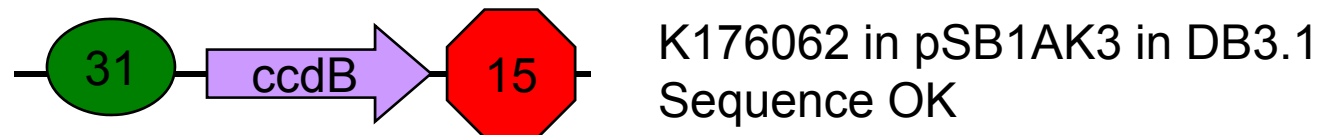
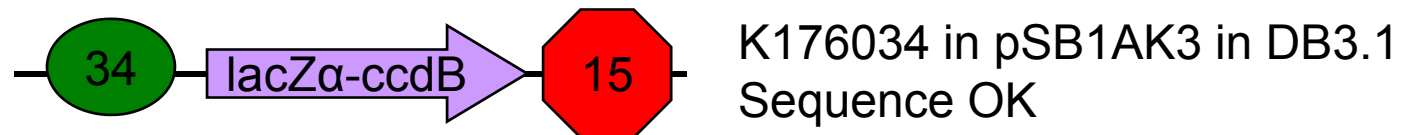
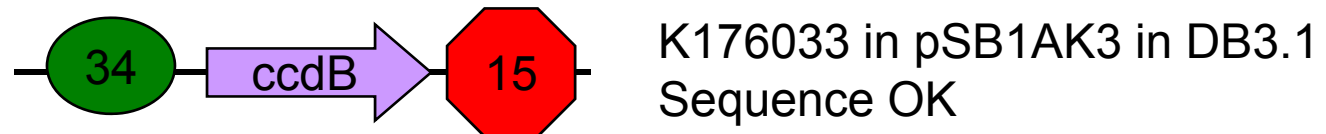
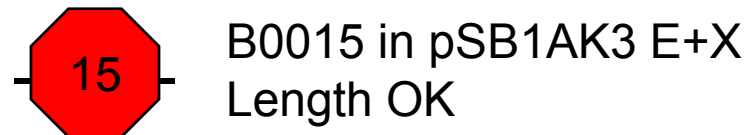
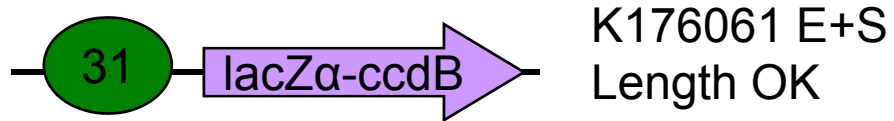
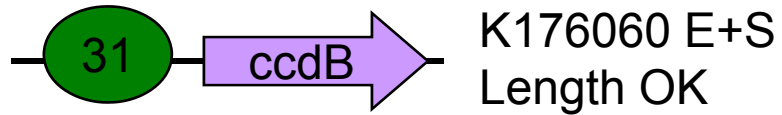

5

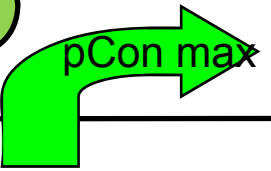
 J23119 in pSB1A2  
Sequence OK

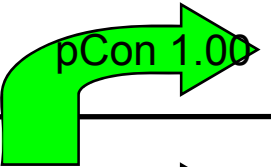
 J23100 in J61002  
Sequence ?

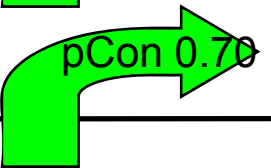
 J23101 in J61002  
Sequence OK

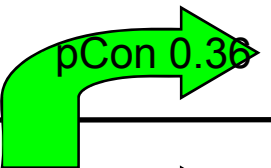
 K176009 in J61002  
Sequence OK

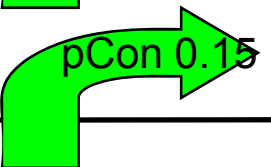
 K176008 in J61002  
Sequence OK

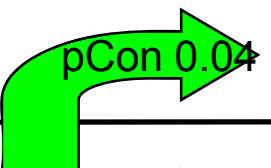
 J23109 in J61002  
Sequence OK

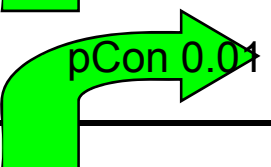
 J23103 in J61002  
Sequence OK

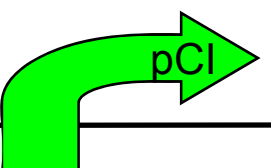
 R0051 in pSB1A2  
Sequence OK

 J23119 X+P  
Sequence OK

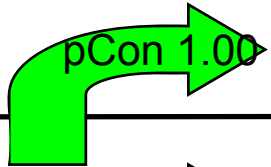
 J23100-J61002SF X+P  
Sequence ?

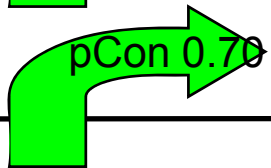
 J23101-J61002SF X+P  
Sequence OK

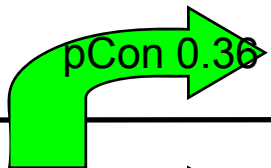
 K176009-J61002SF X+P  
Sequence OK

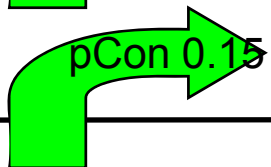
 K176008-J61002SF X+P  
Sequence OK

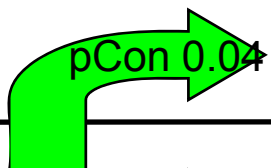
 J23109-J61002SF X+P  
Sequence OK

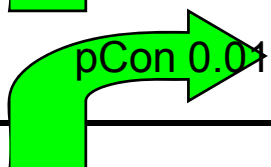
 J23103-J61002SF X+P  
Sequence OK

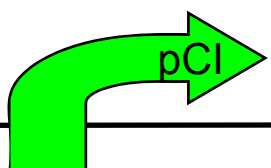
 R0051 X+P  
Length OK

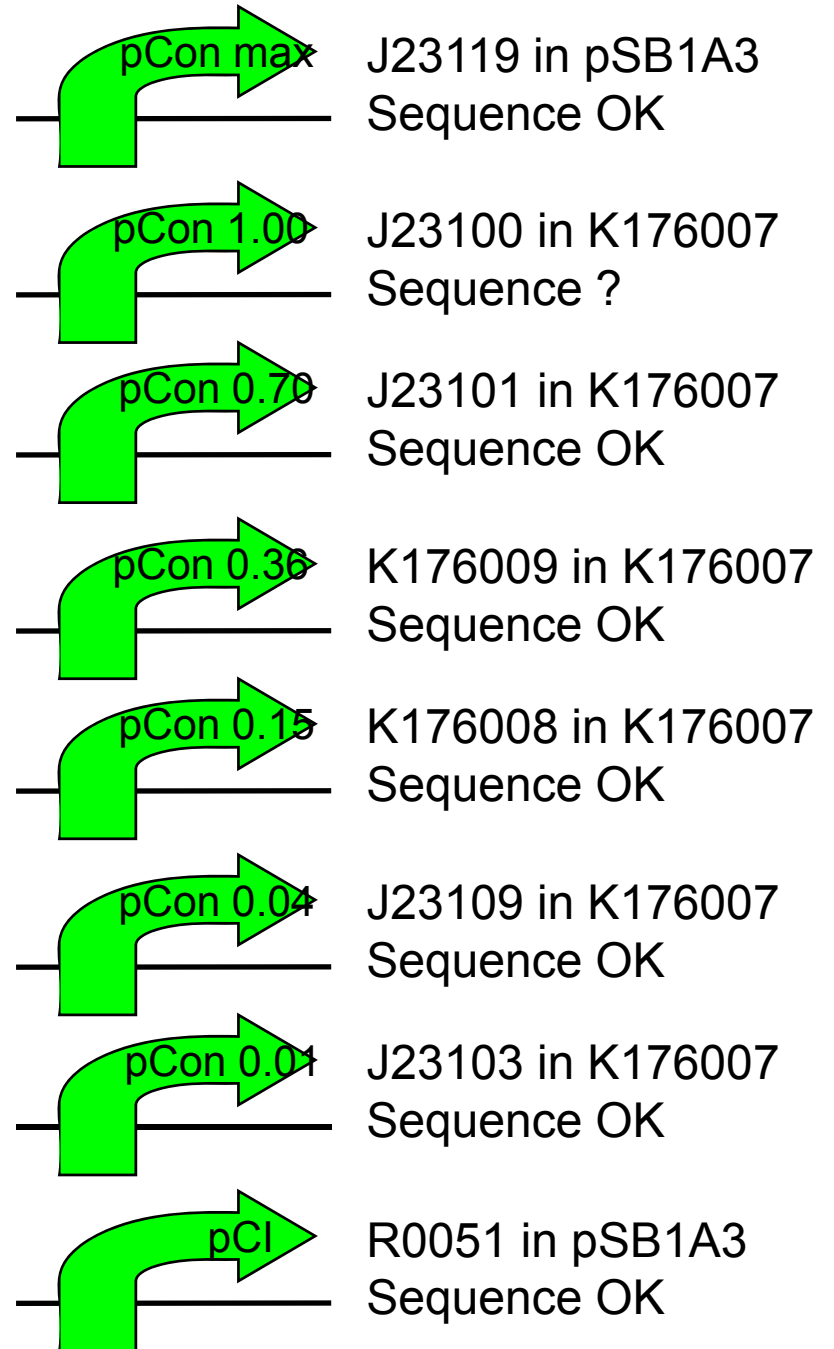

6

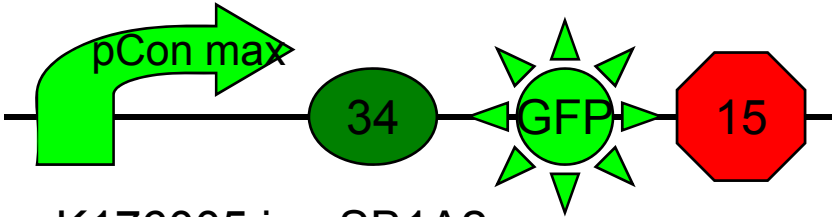
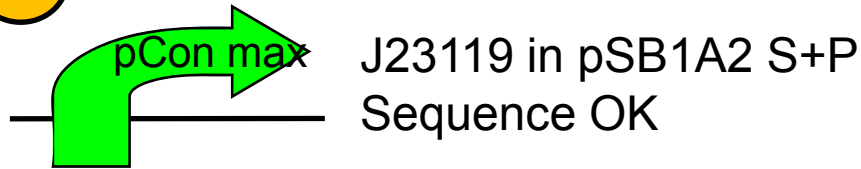

K176005 in pSB1A2  
Sequence OK

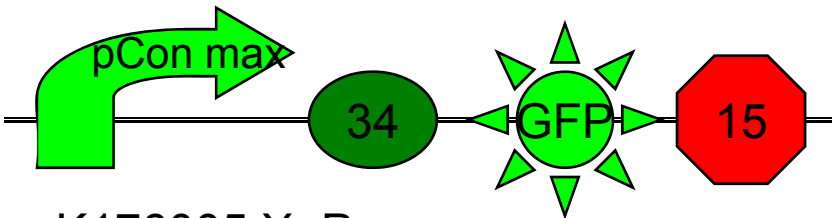

K176005 X+P  
Length OK

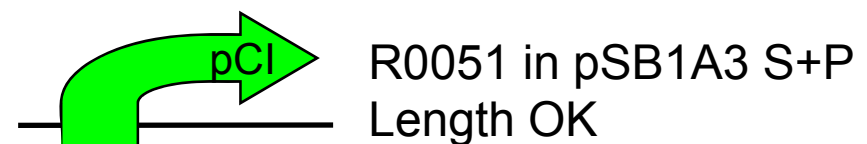
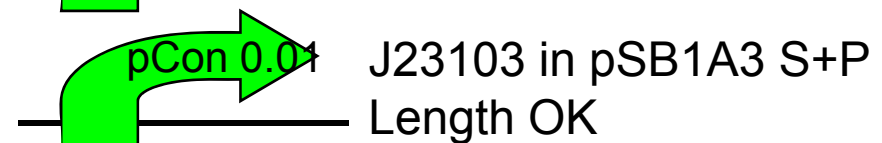
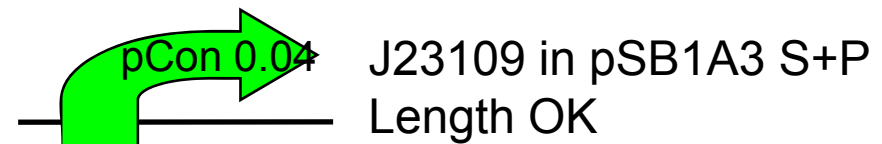
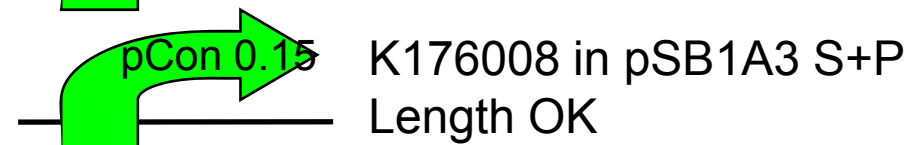
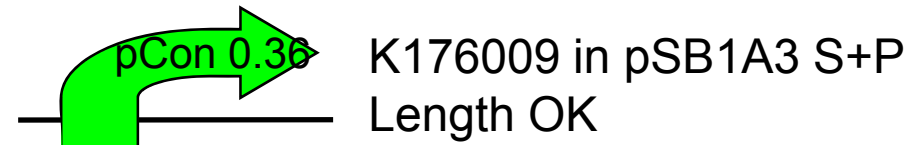
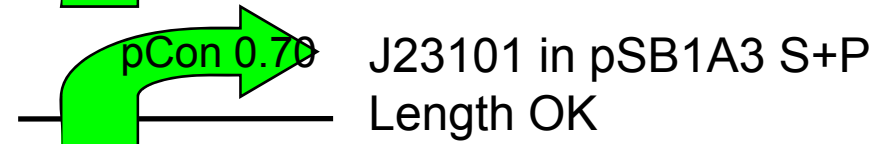
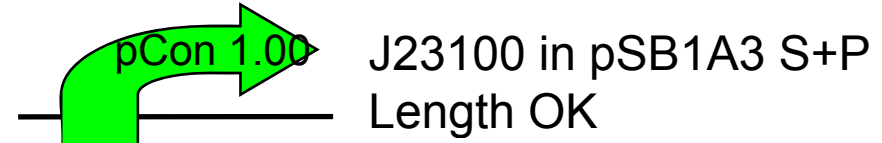
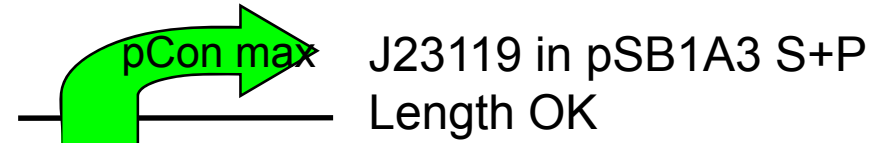

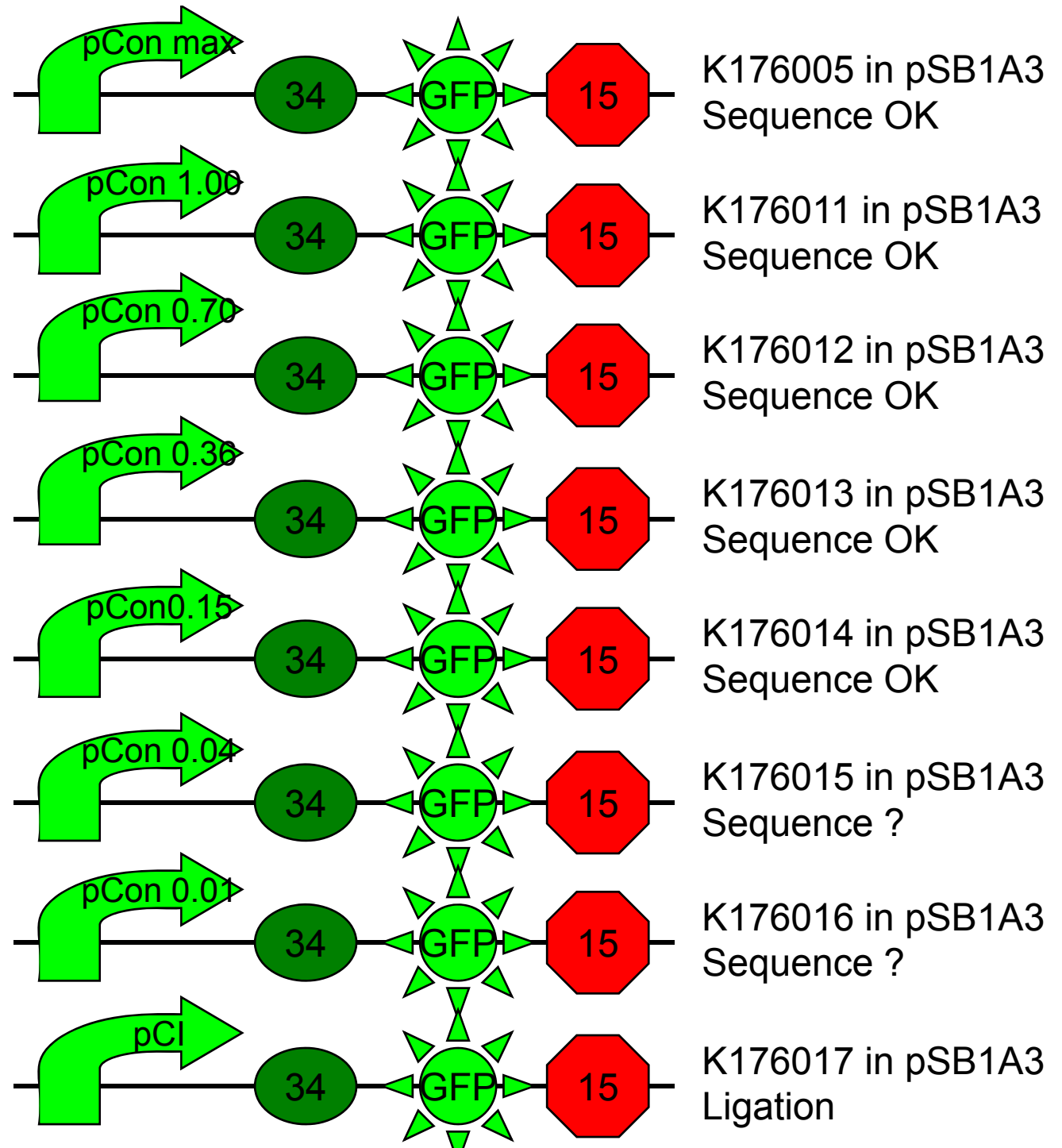

# Flu:OD

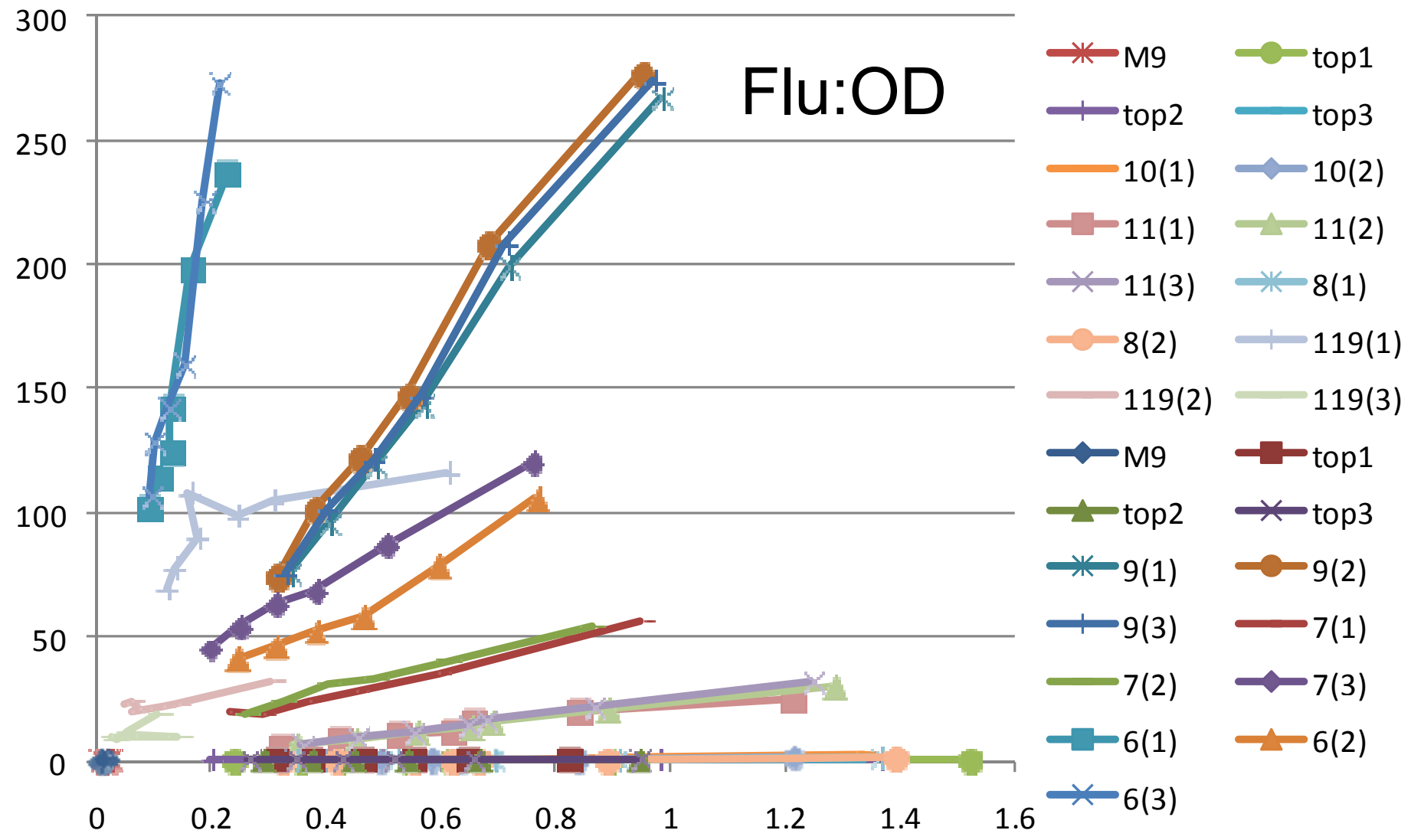







7

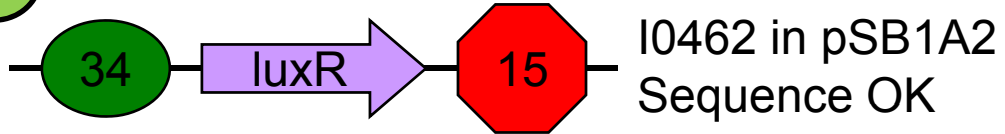

I0462 in pSB1A2  
Sequence OK

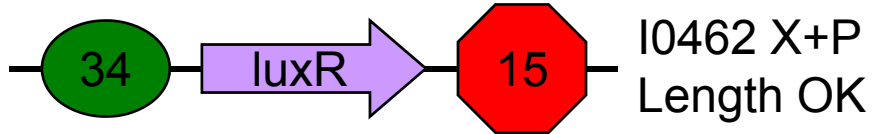

I0462 X+P  
Length OK

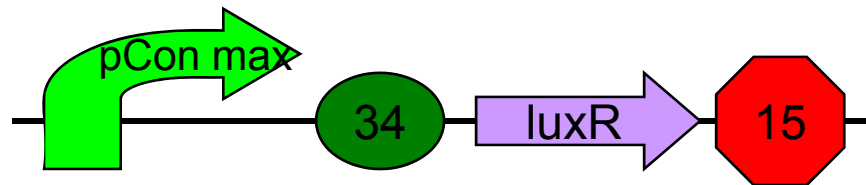

K176004 in pSB1A2  
Sequence OK  
Length ?

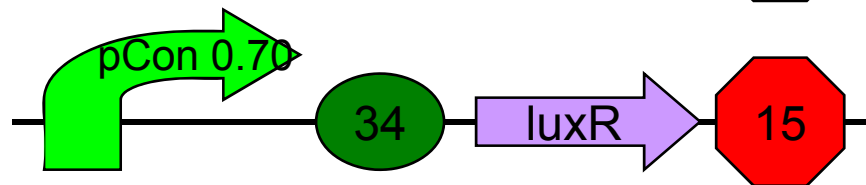

K176025 in pSB1A3  
Sequence ?

8

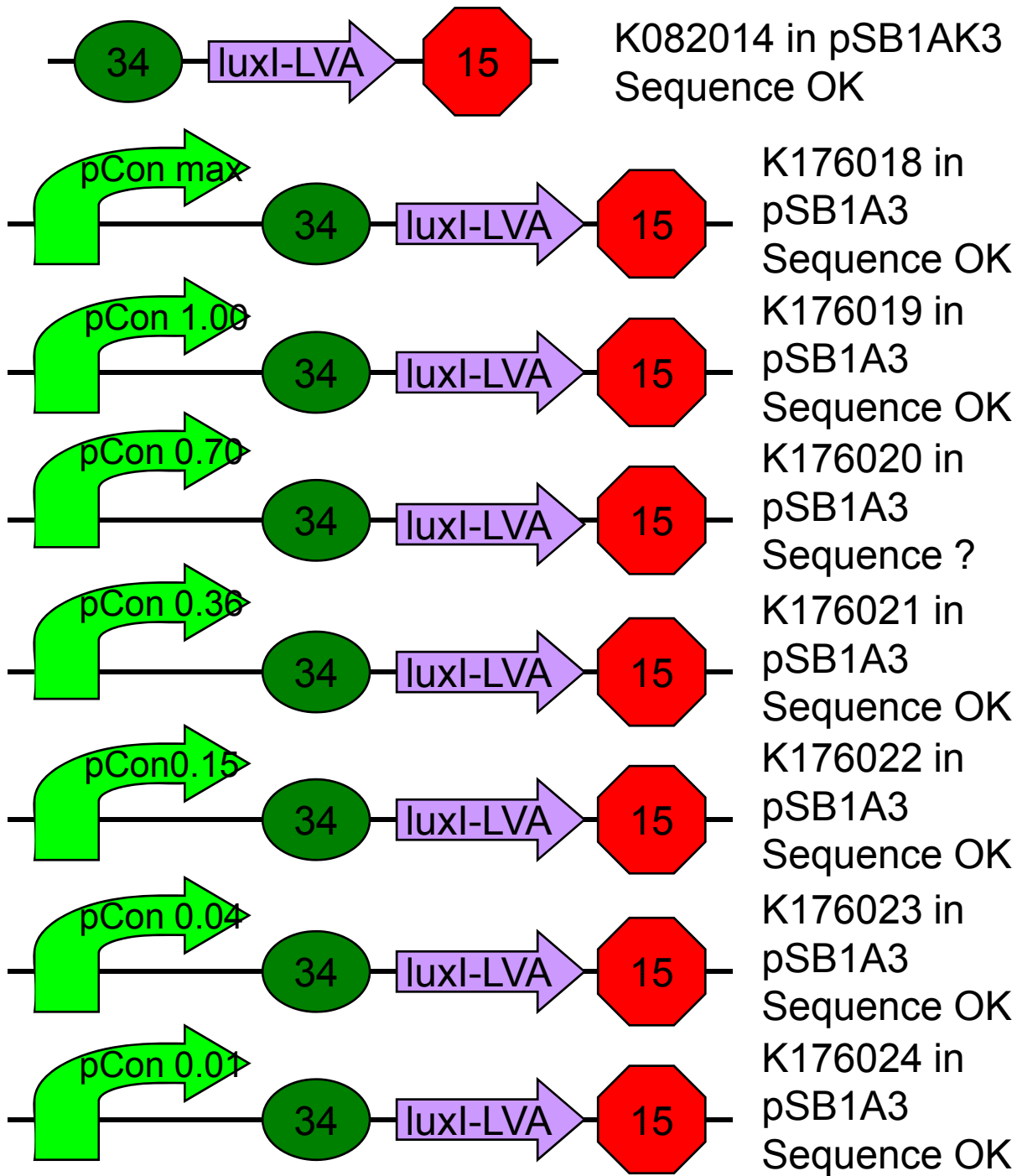

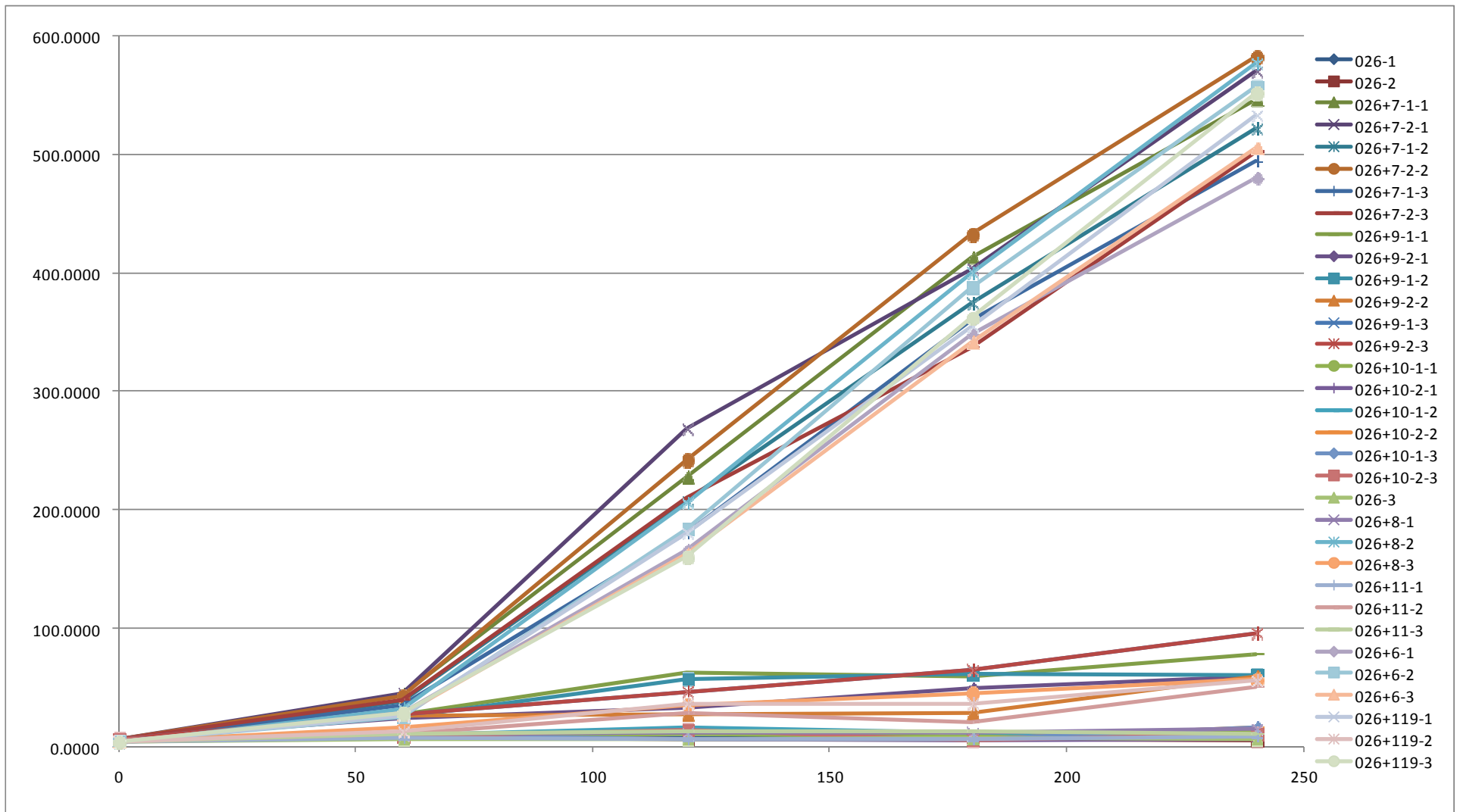

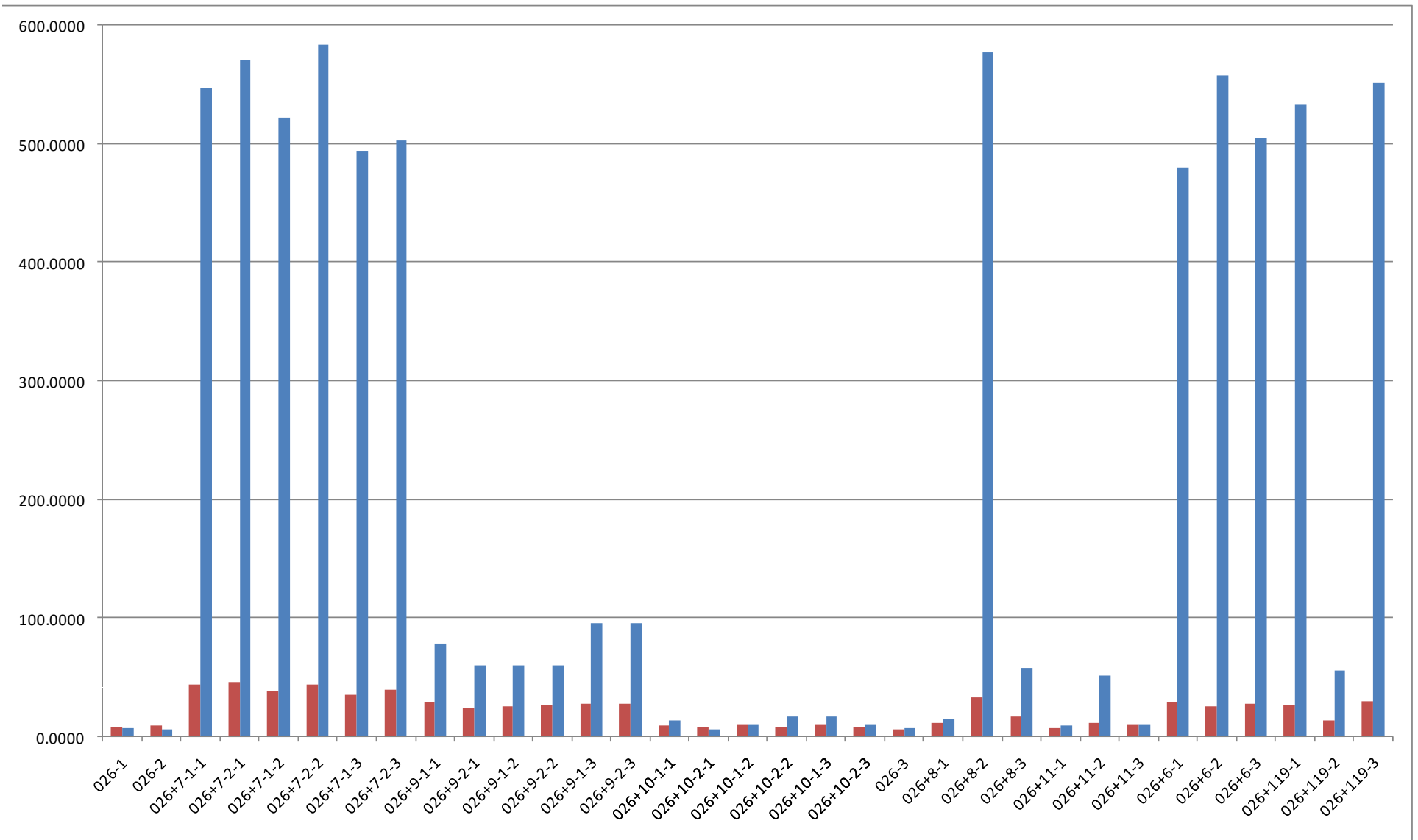

3

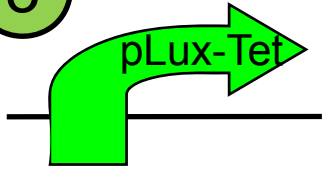

K176000 in pSB1A3 E+X  
Length OK

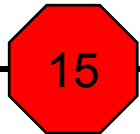
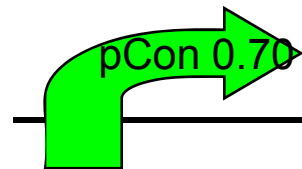

K176025 E+S  
Length OK

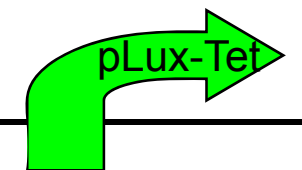
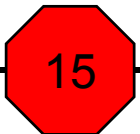
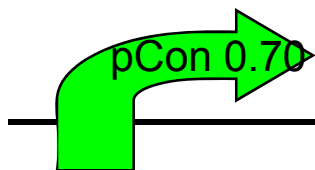

K176028 in pSB1A3  
Sequence ?

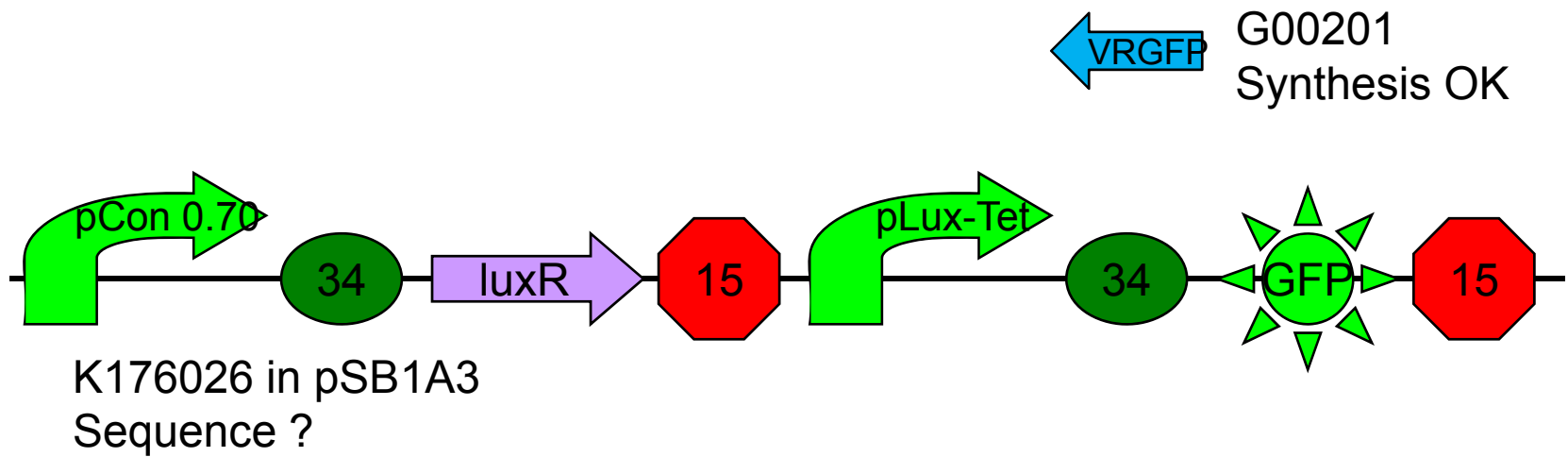
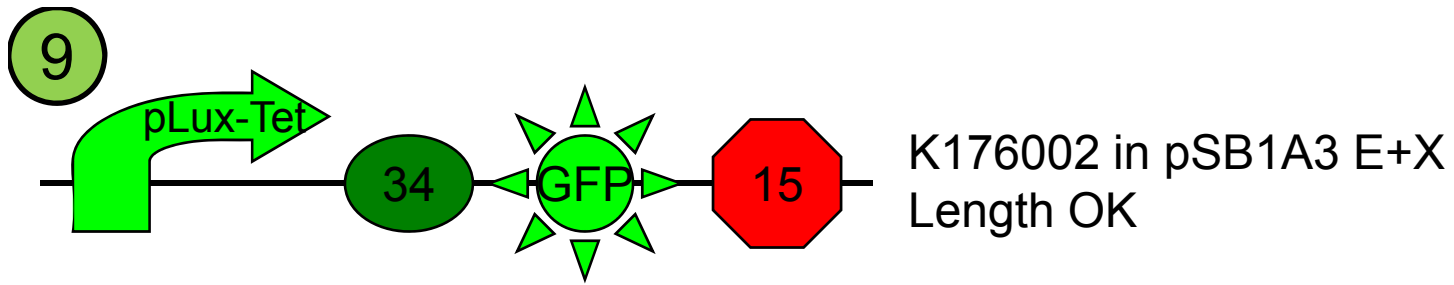



# Methods

- Plate Reader
- Spectrophotometer

Flu:t(min)

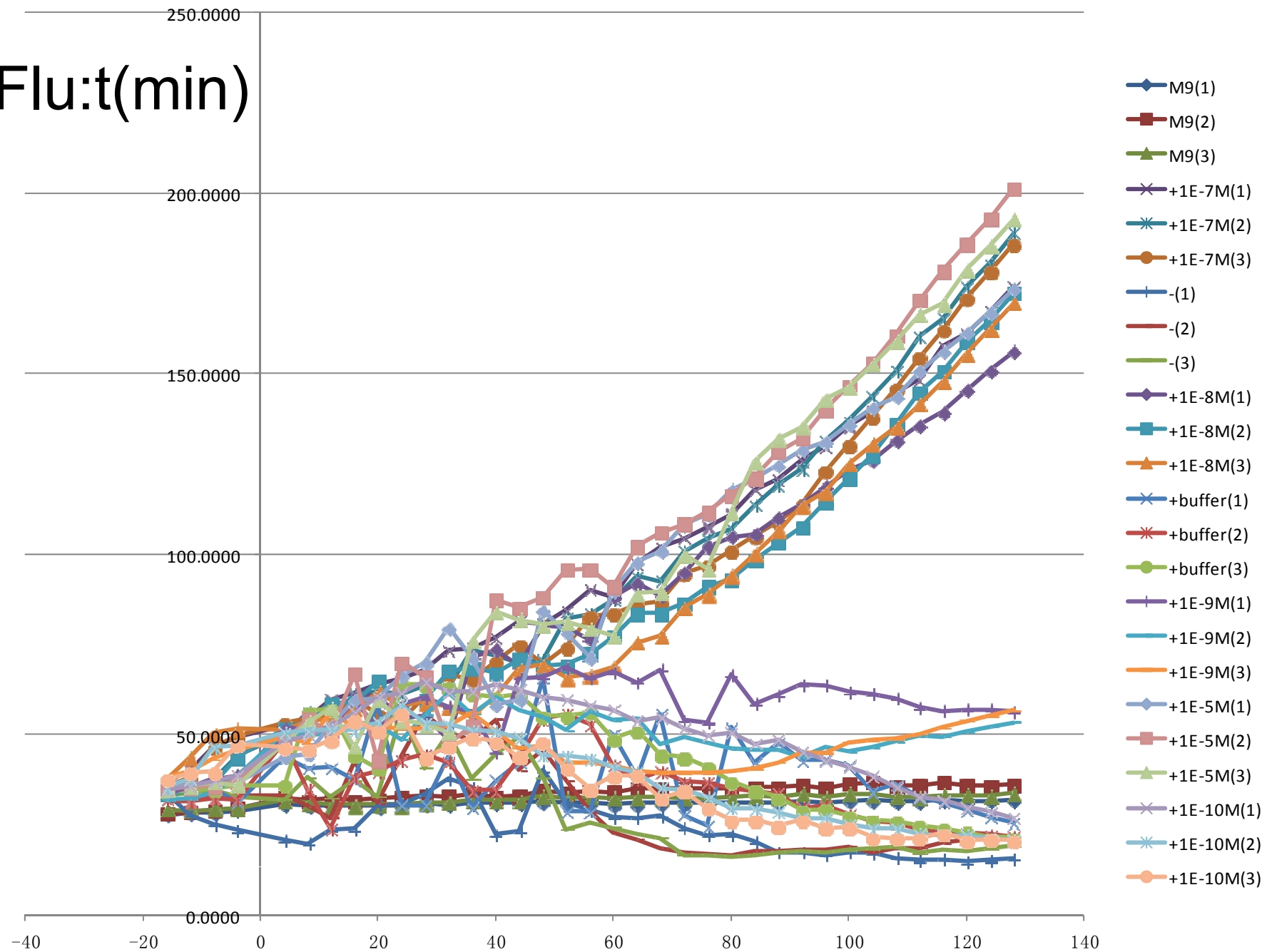

# Flu/OD:t(min)

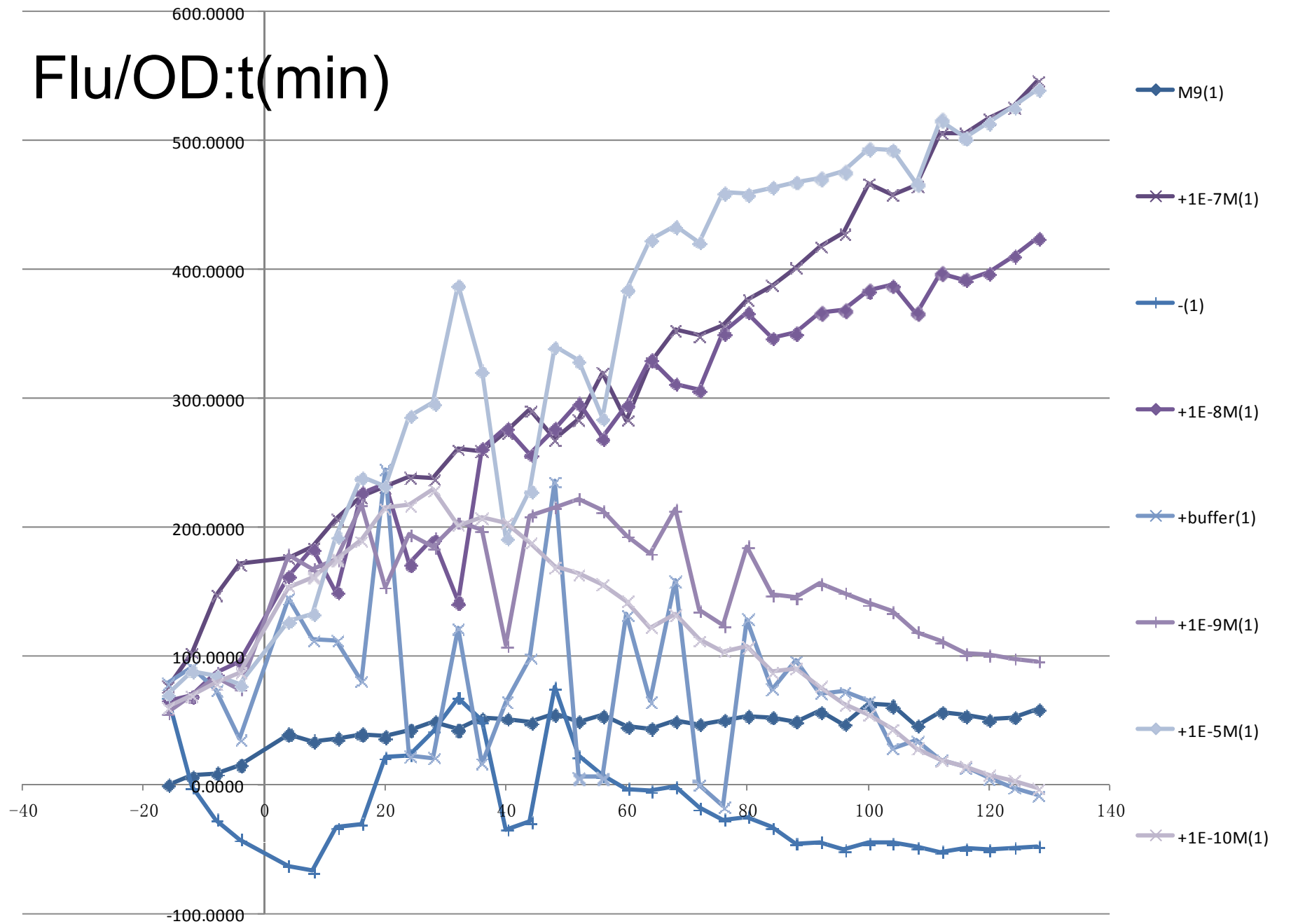

# Flu/OD:t(min)

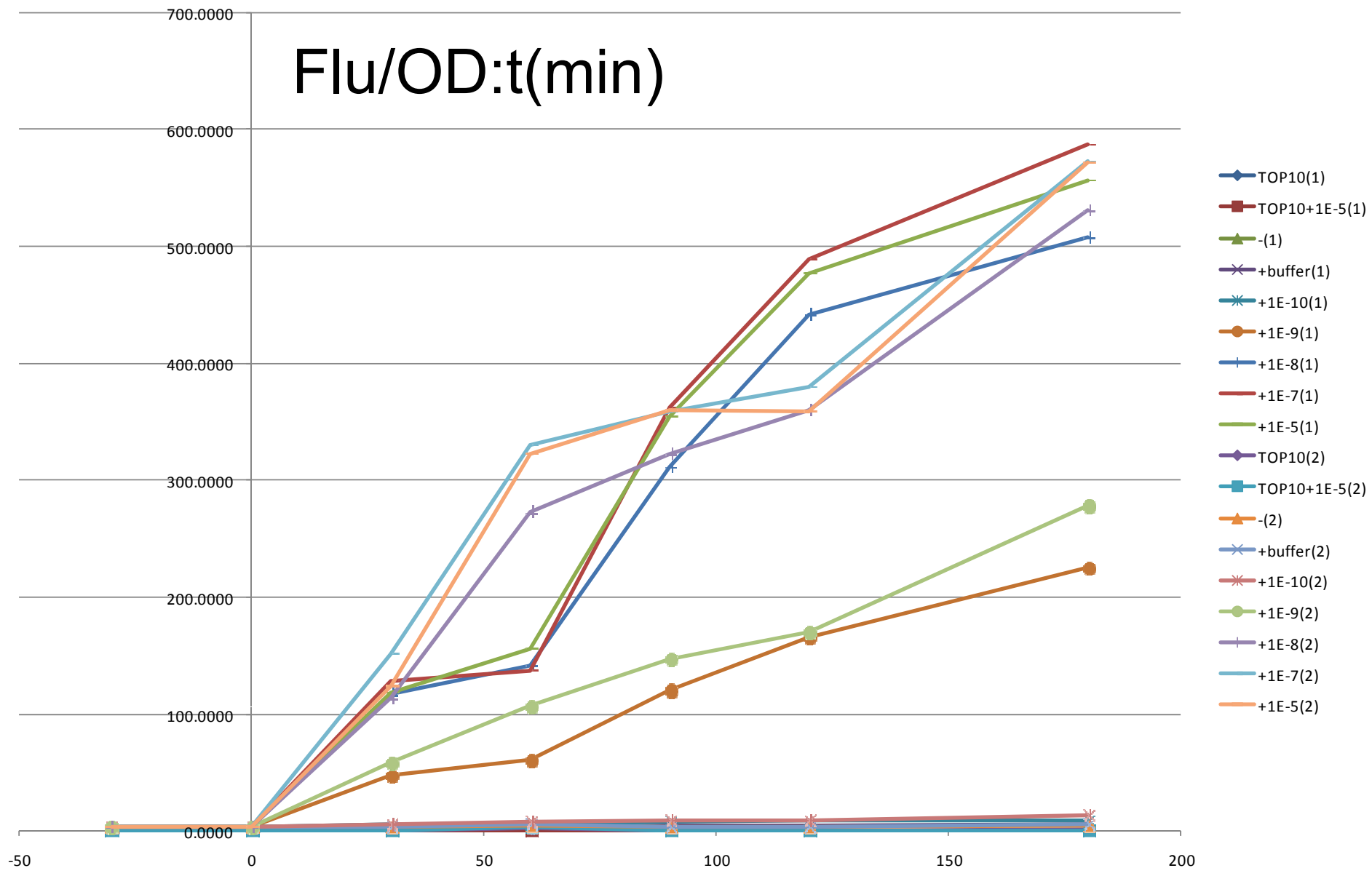

# Flu/OD:t(min)

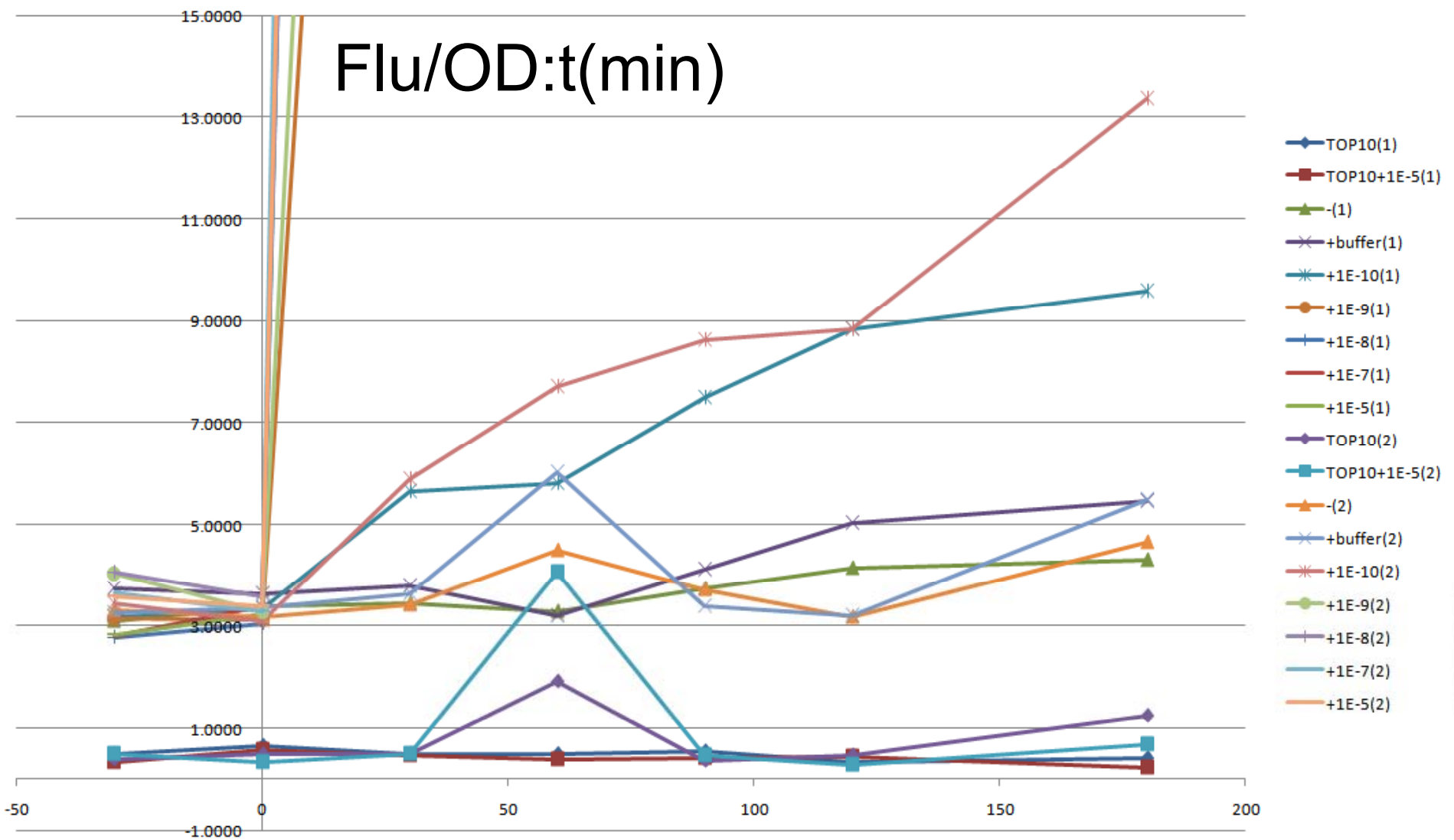

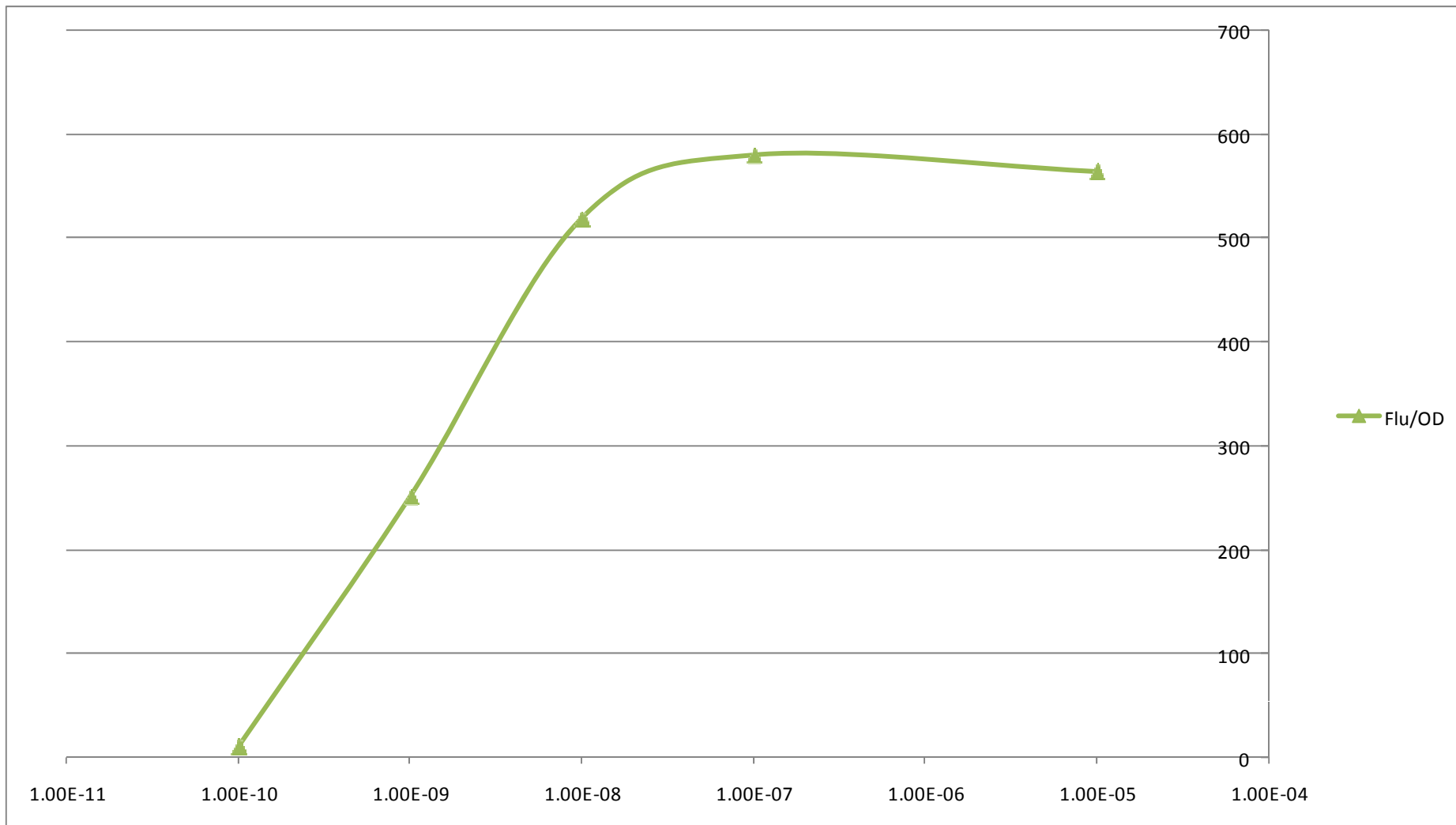

# F2620

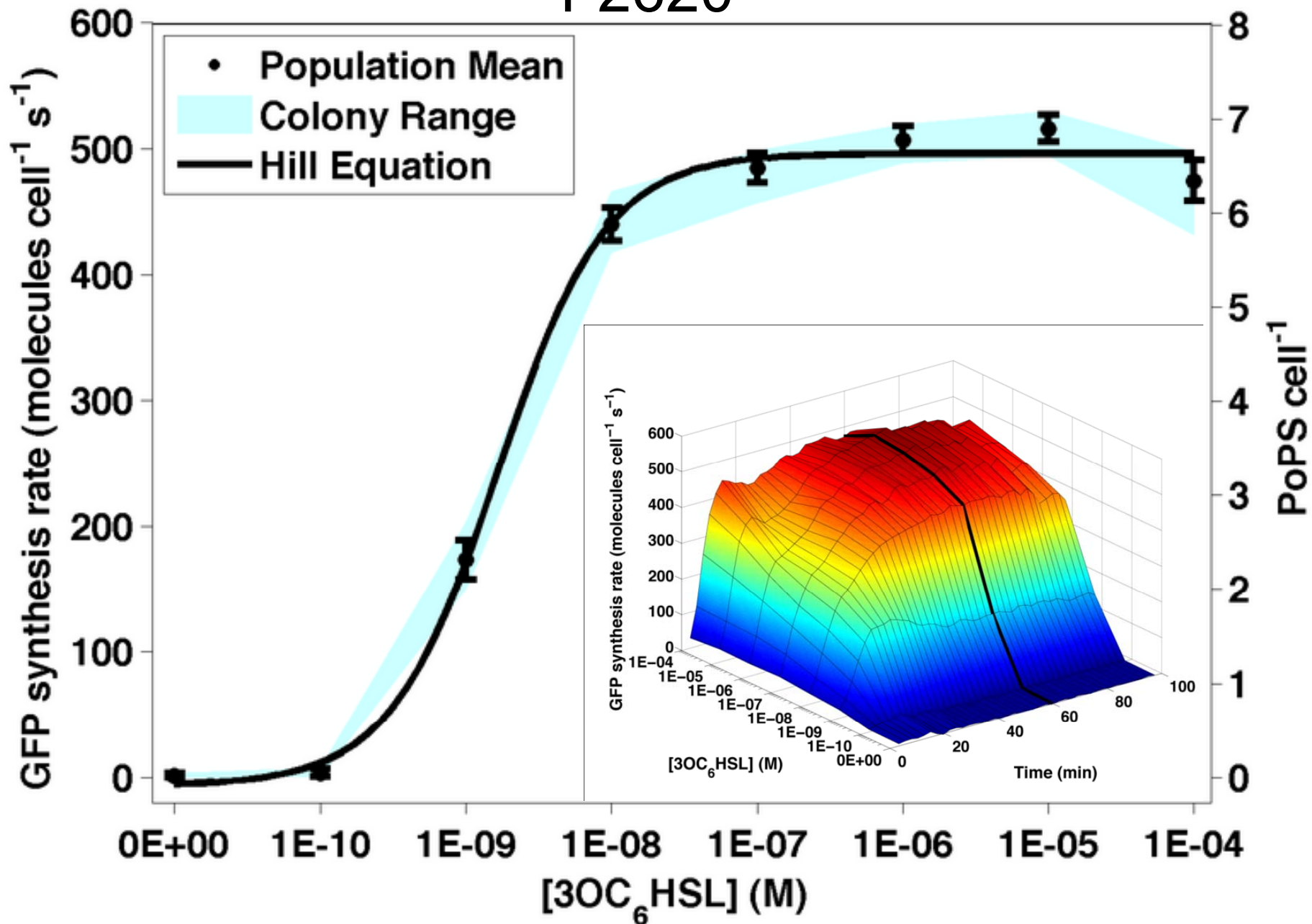

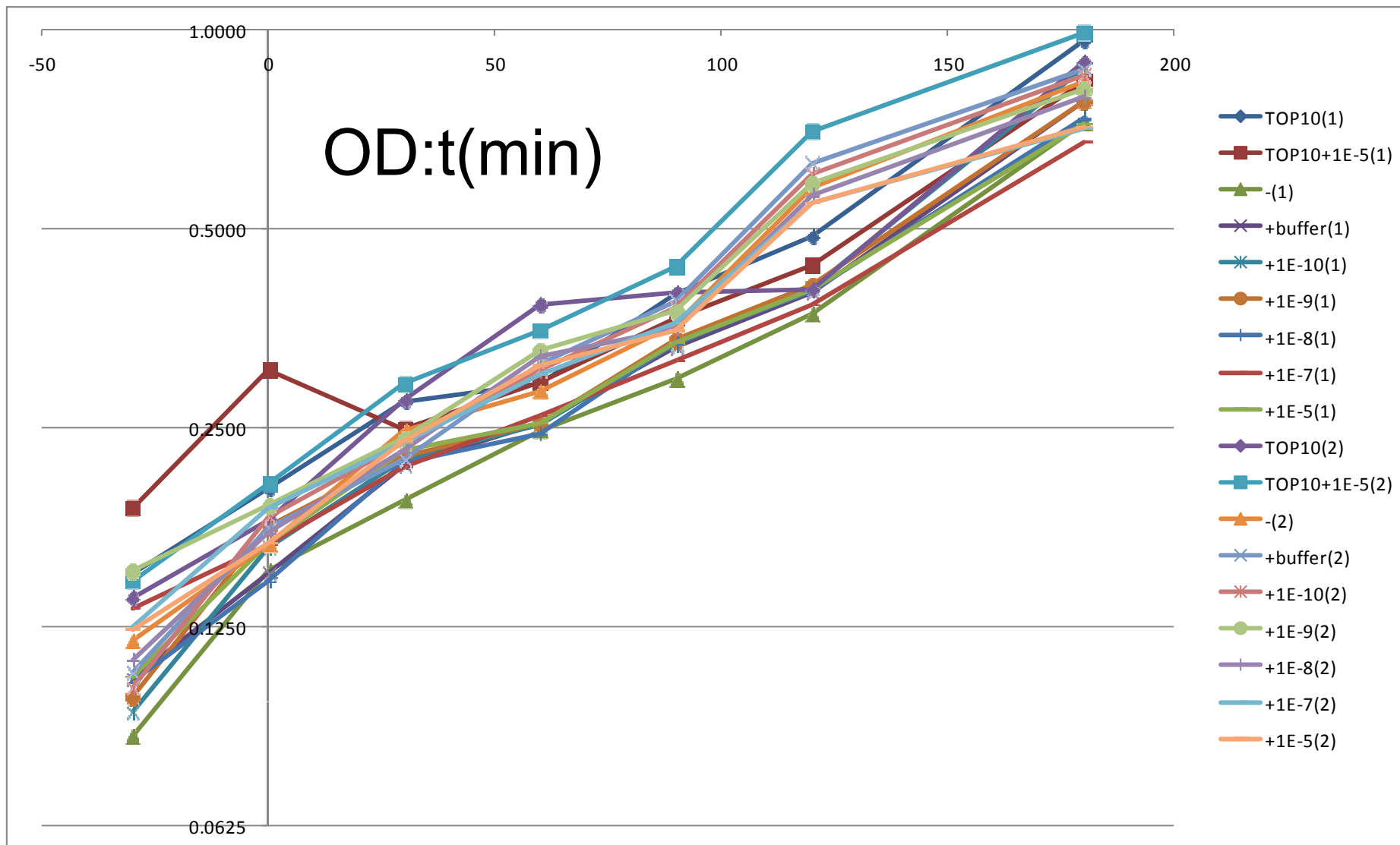



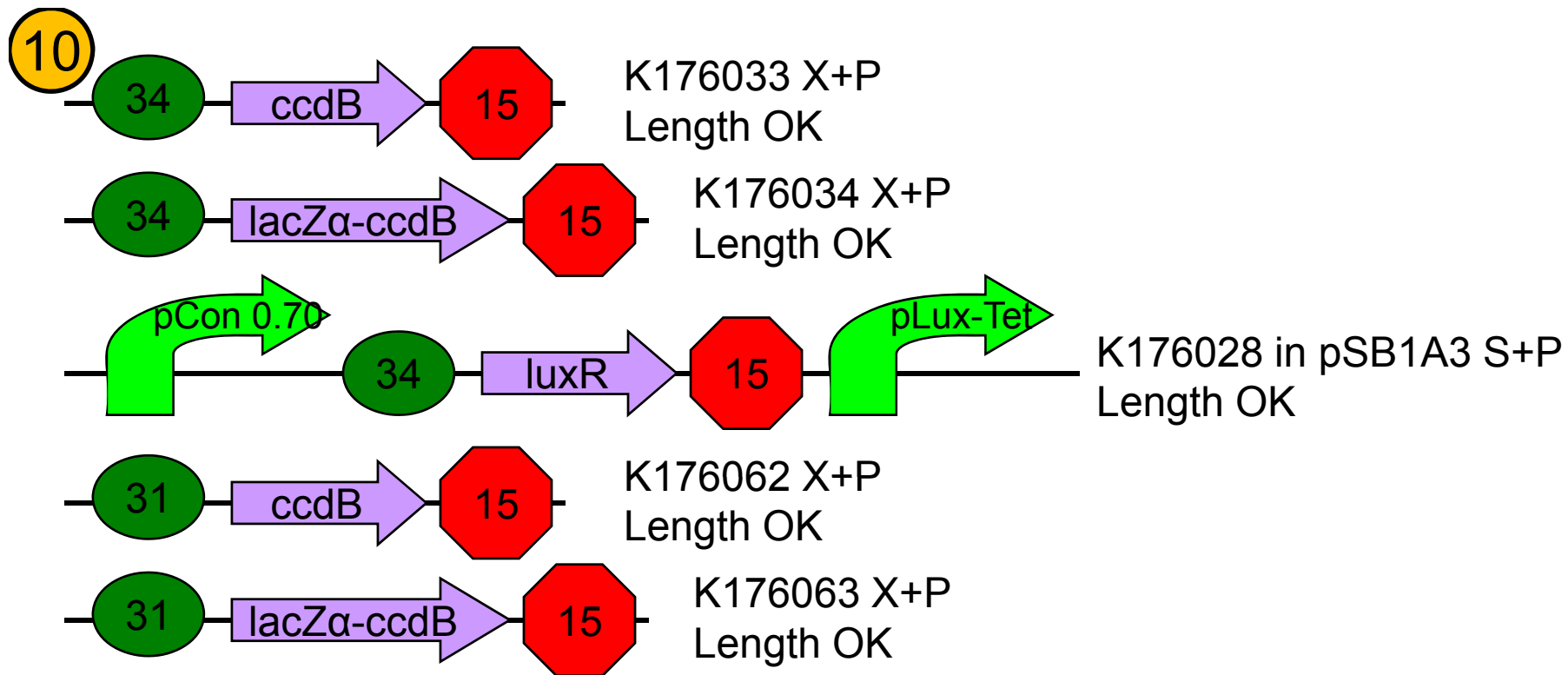

← VRccdB K176058  
Synthesis OK

← M13-47 K176059  
Synthesis OK

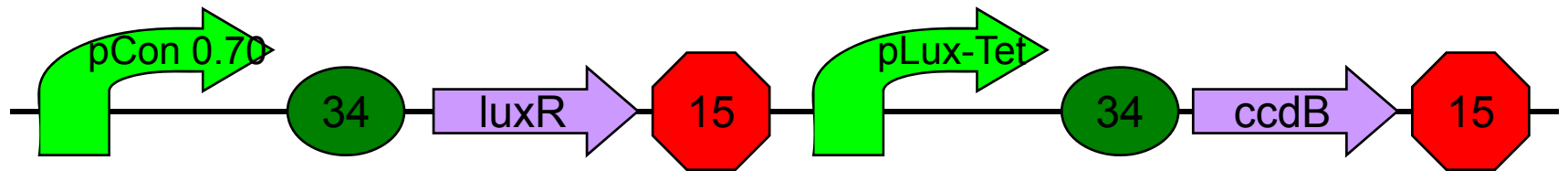

K176035 in pSB1A3 in DB3.1  
Sequence ?

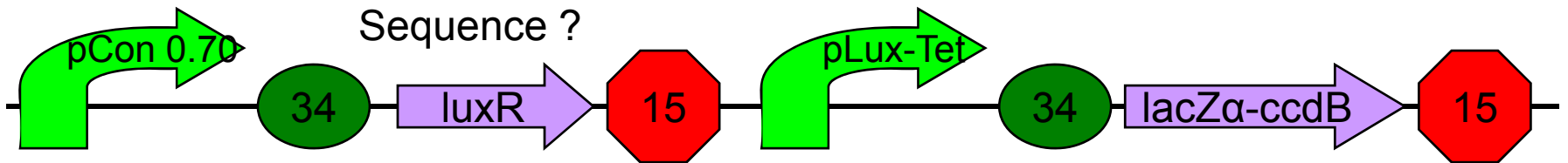

K176036 in pSB1A3 in DB3.1  
Sequence OK

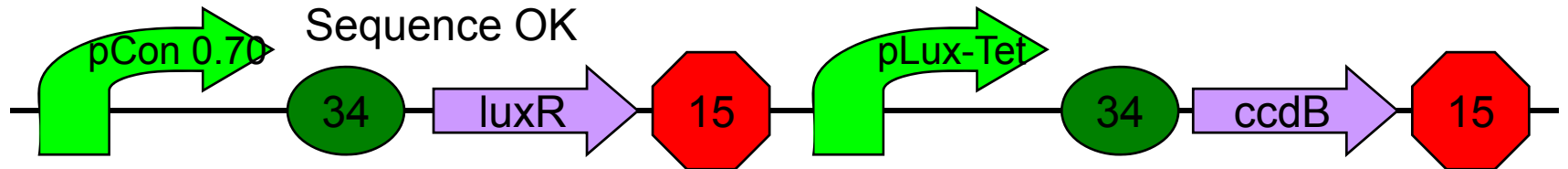

K176035 in pSB1A3 in TOP10  
Transformation Fail

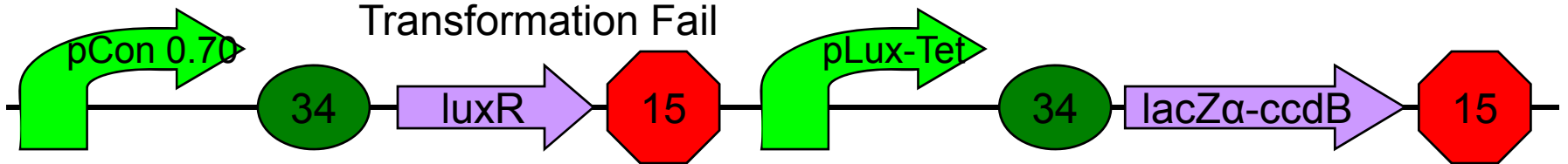

K176036 in pSB1A3 in TOP10  
Transformation Fail

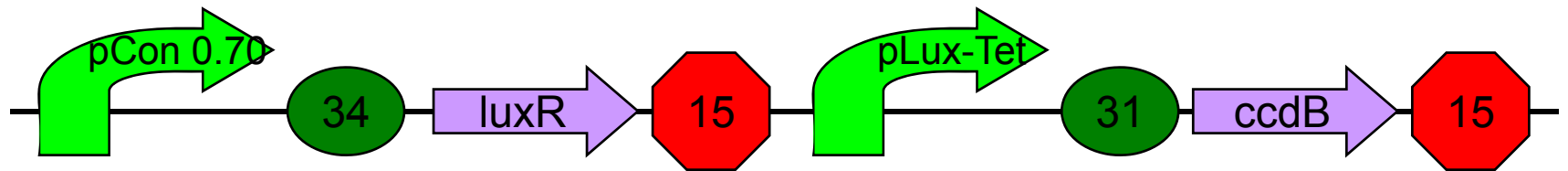

K176089 in pSB1A3 in DB3.1

Ligation

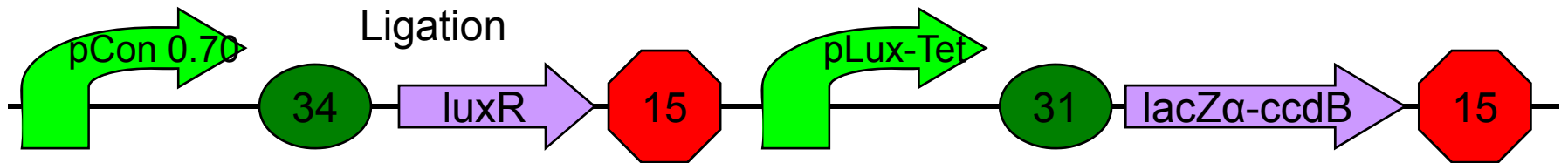

K176090 in pSB1A3 in DB3.1

Sequence ?

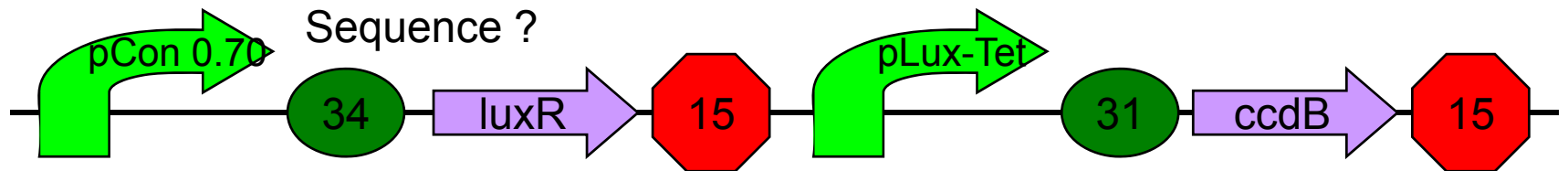

K176089 in pSB1A3 in TOP10

Waiting

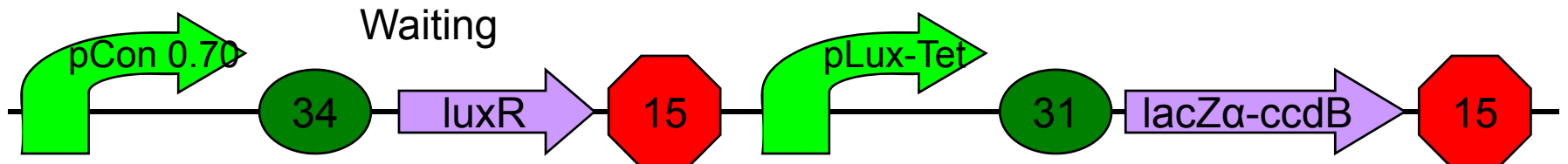

K176090 in pSB1A3 in TOP10

Transformation

11

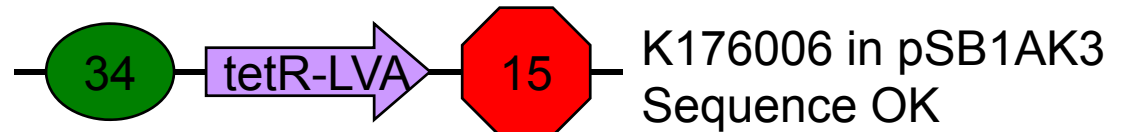
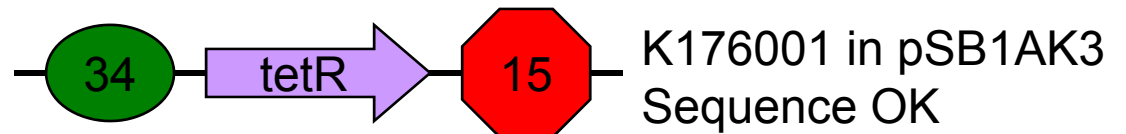
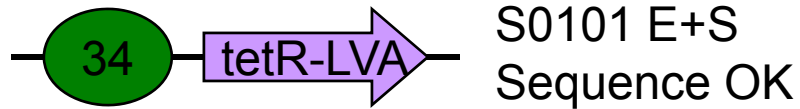
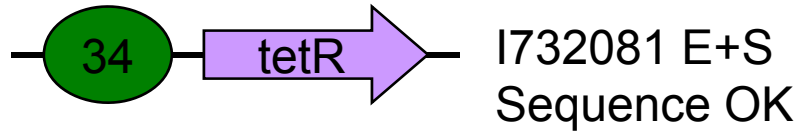
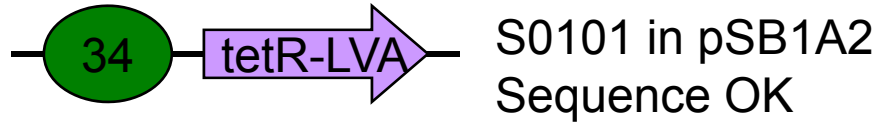
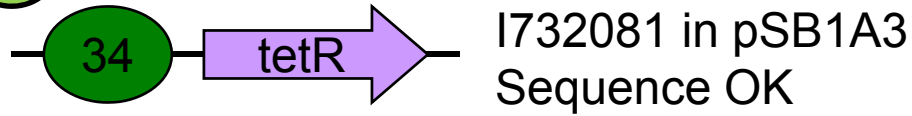

12

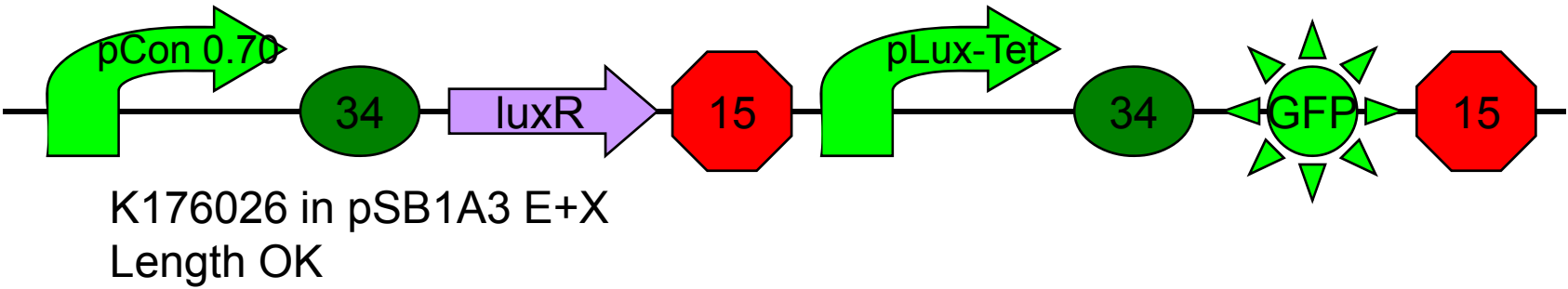
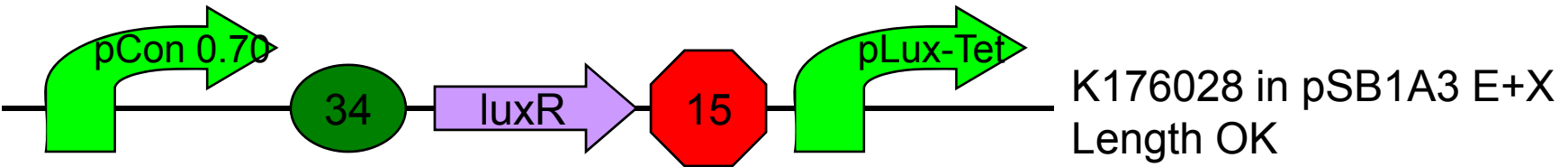
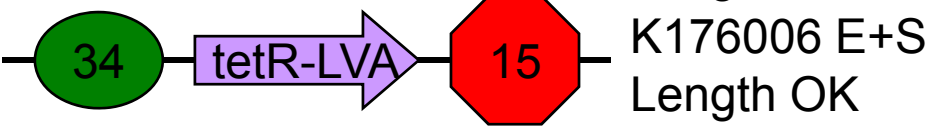
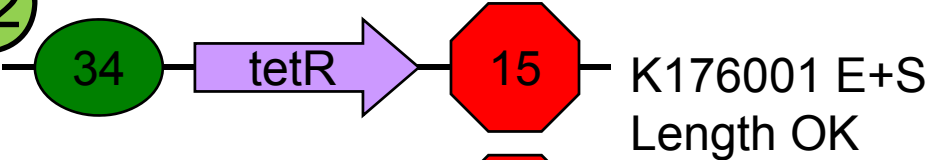



K176057  
Synthesis OK

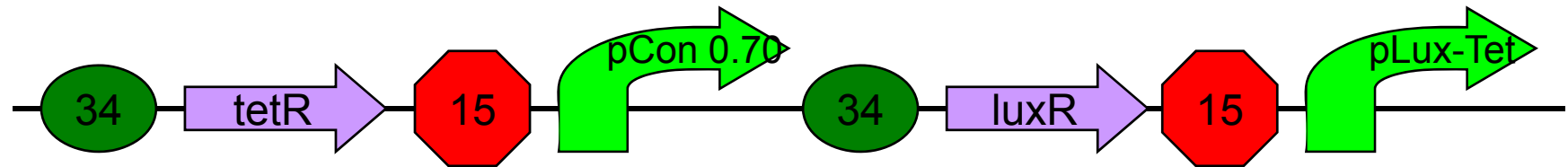

K176031 in pSB1A3  
Sequence OK

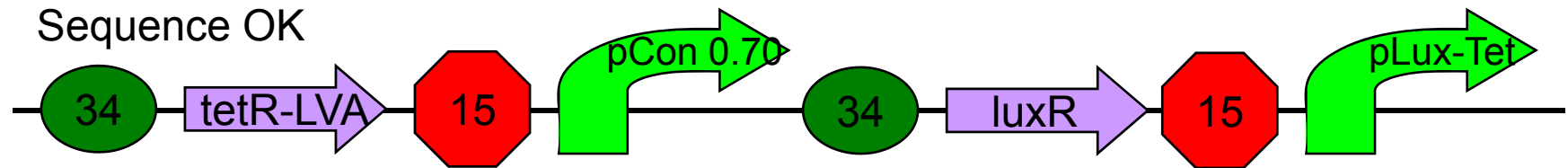

K176032 in pSB1A3  
Sequence OK

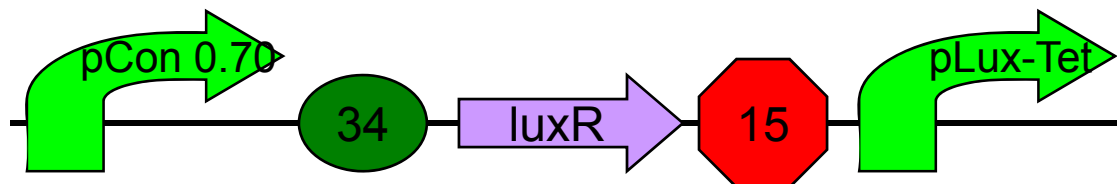
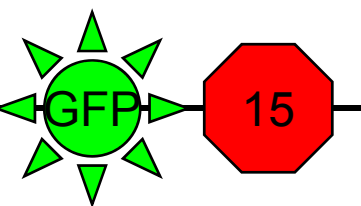
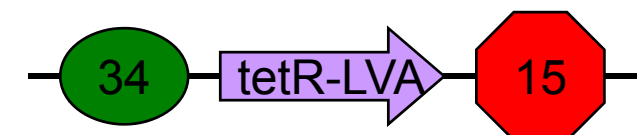
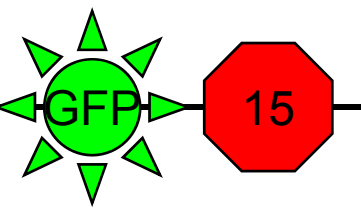
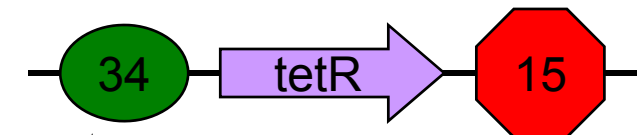

K176029 in pSB1A3  
Sequence ?

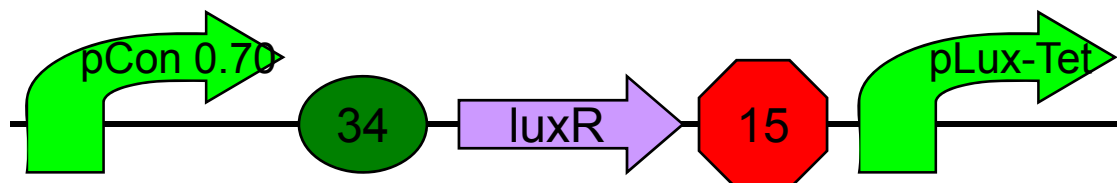

K176030 in pSB1A3  
Sequence ?

13

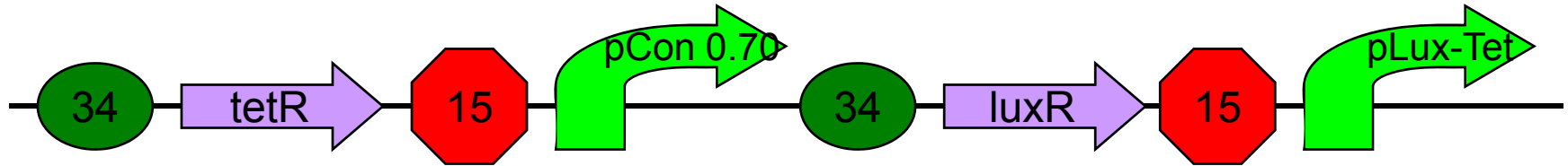

K176031 X+P

Waiting

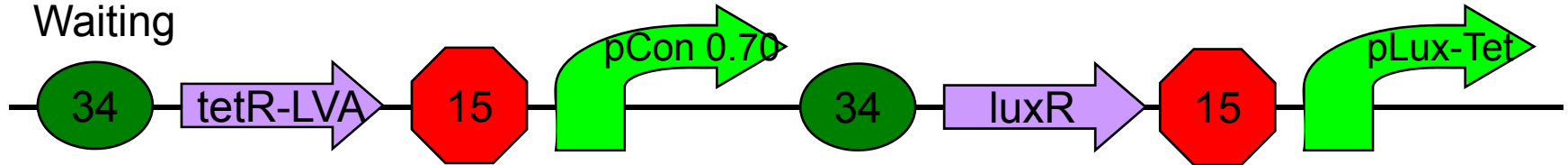

K176032 X+P

Length OK

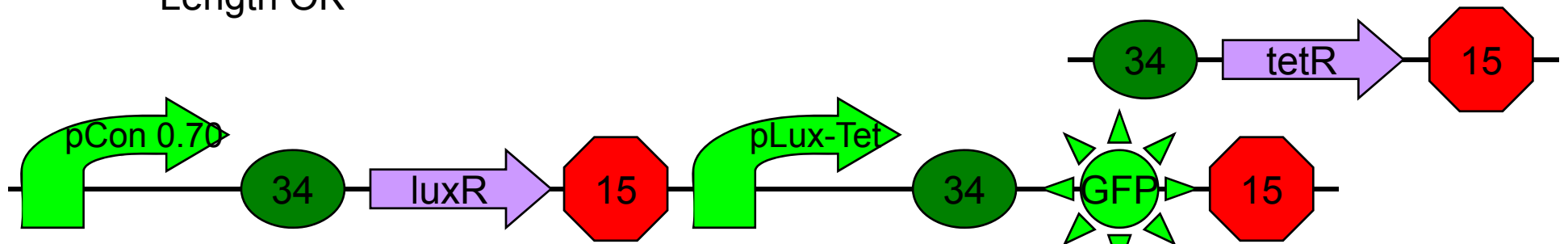

K176029 X+P

Length OK

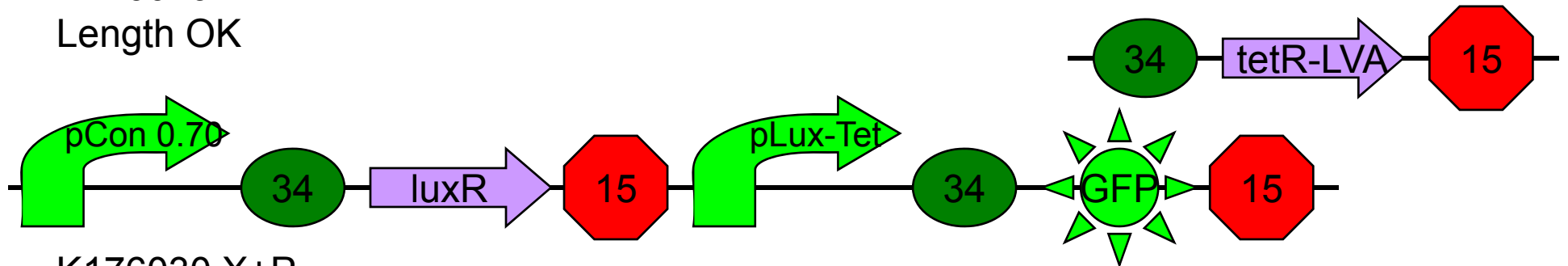

K176030 X+P

Length OK

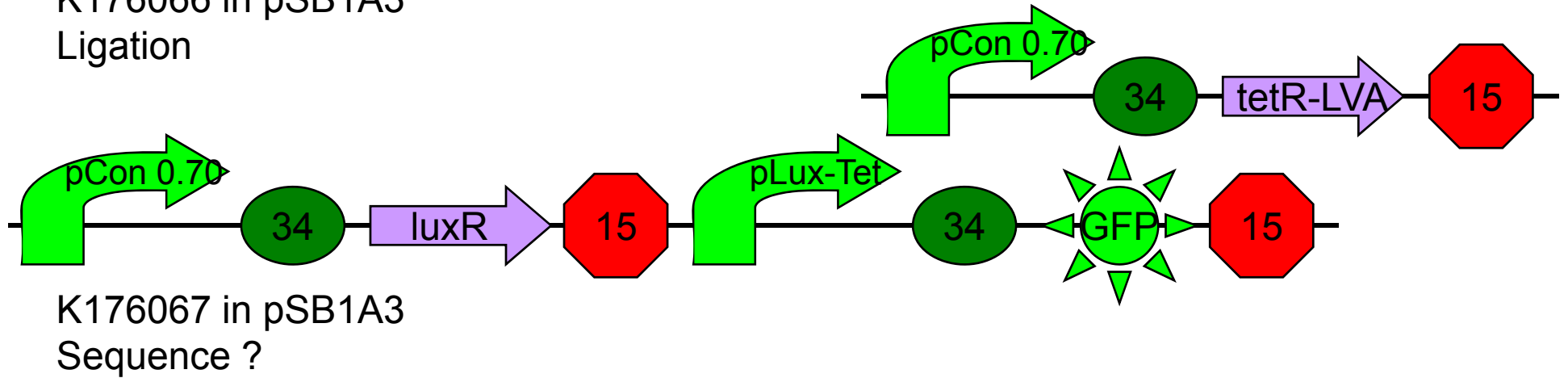
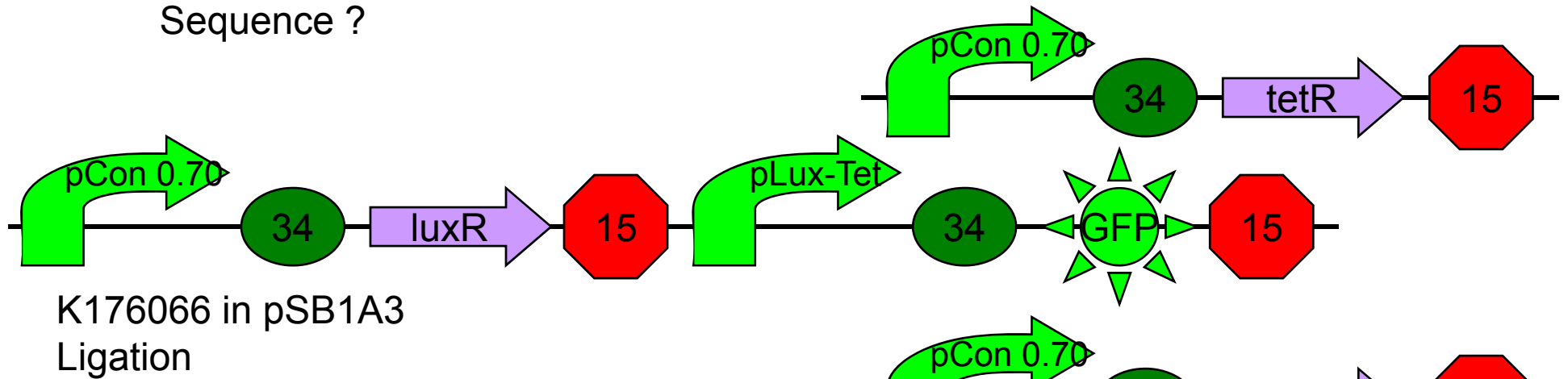
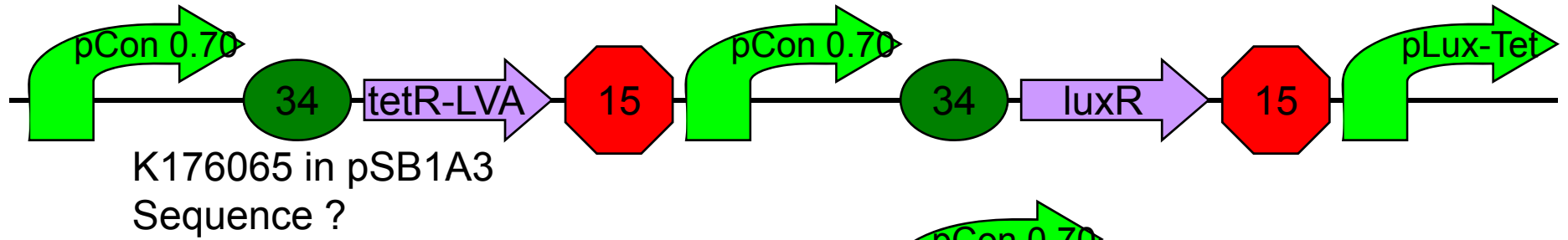
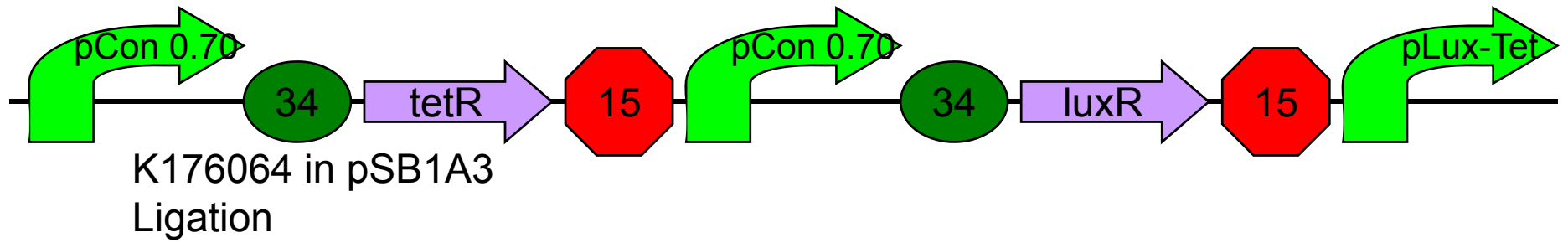



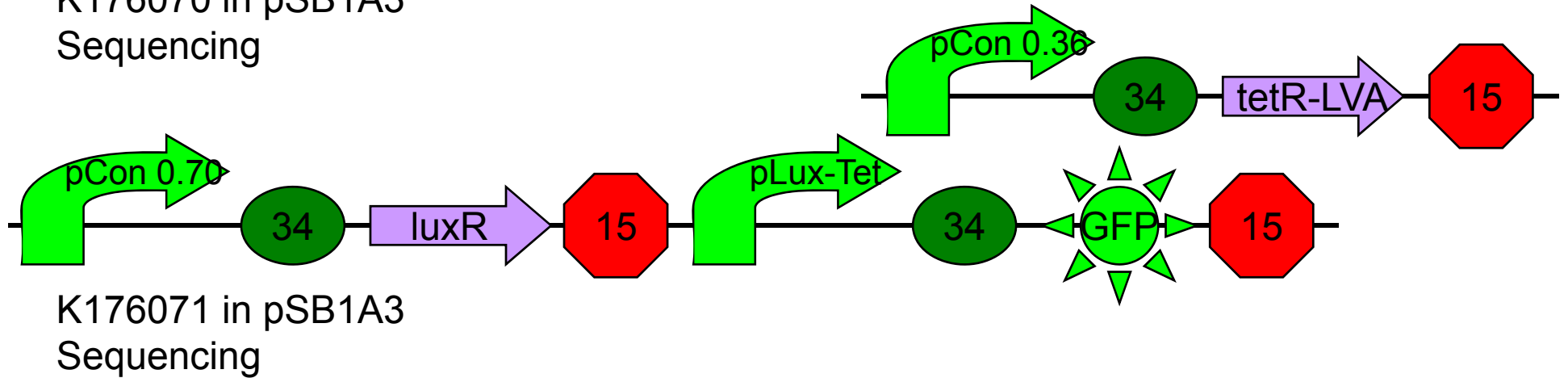
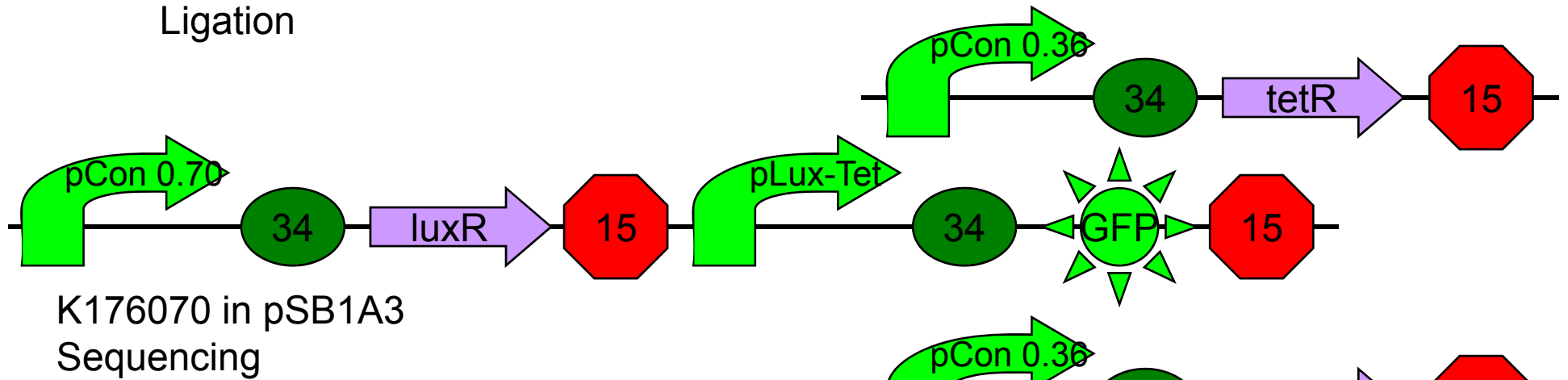
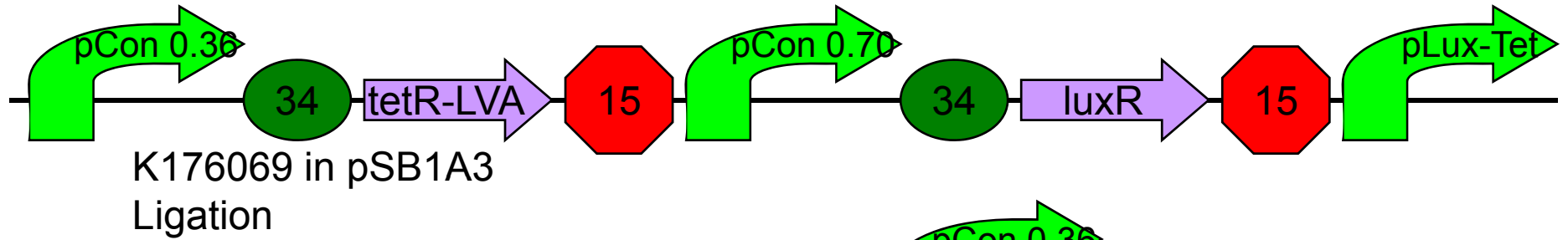
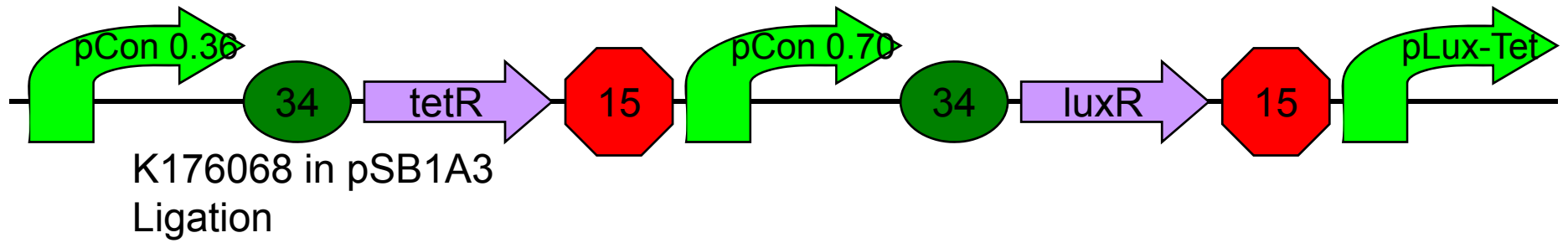

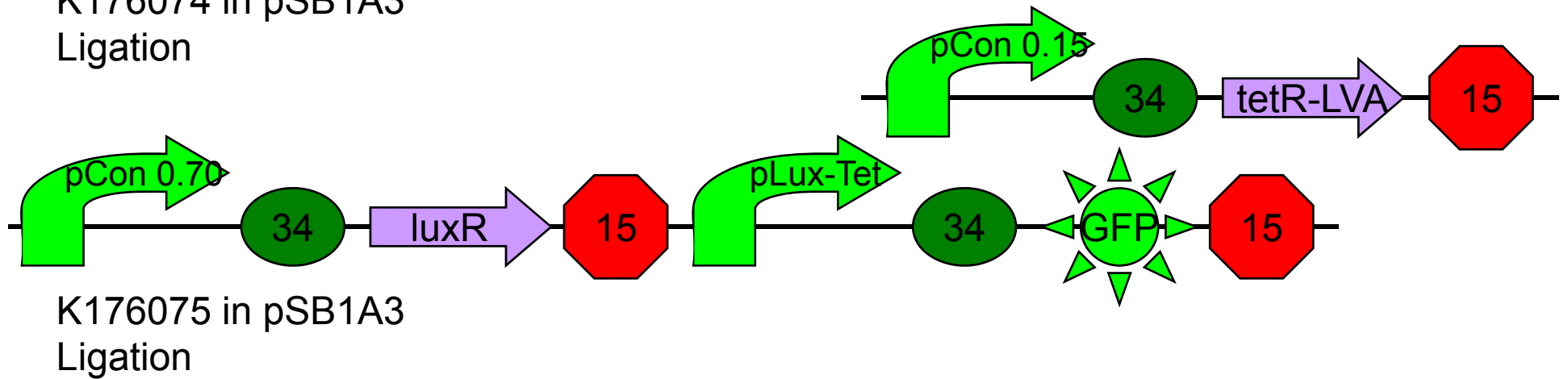
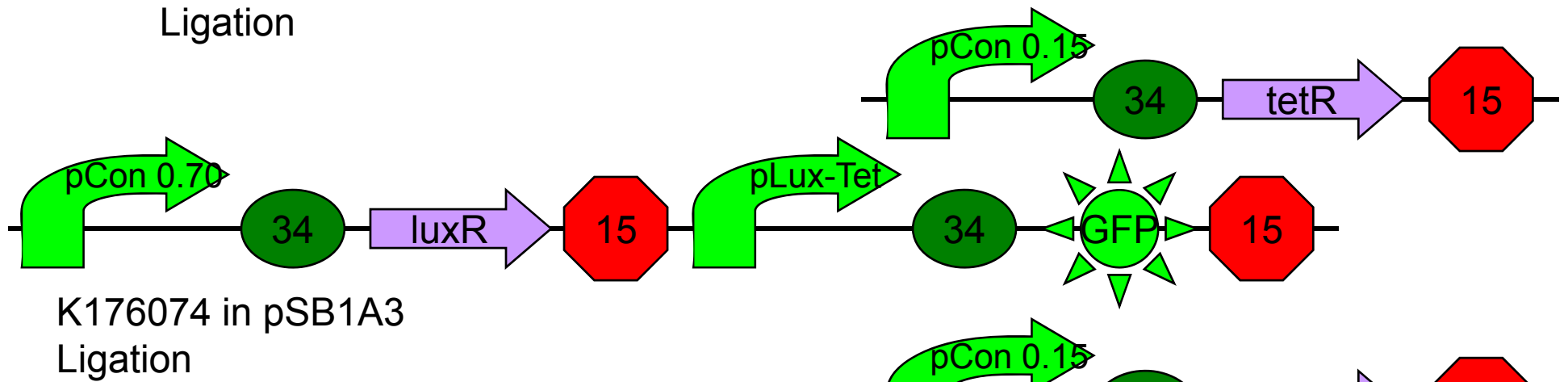
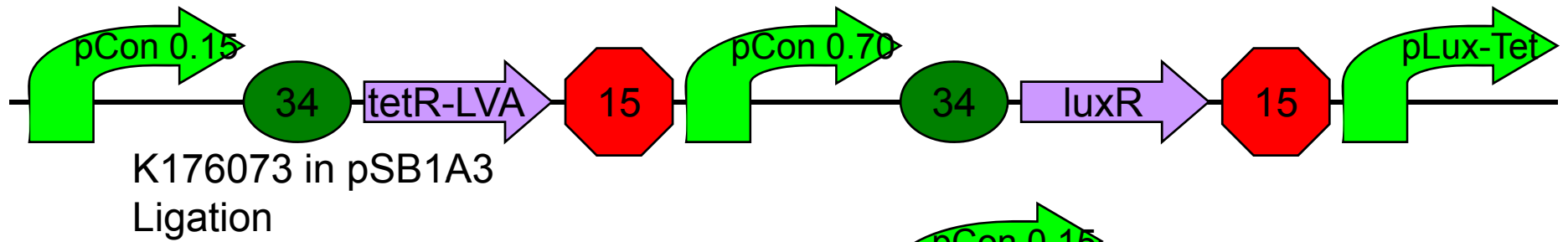
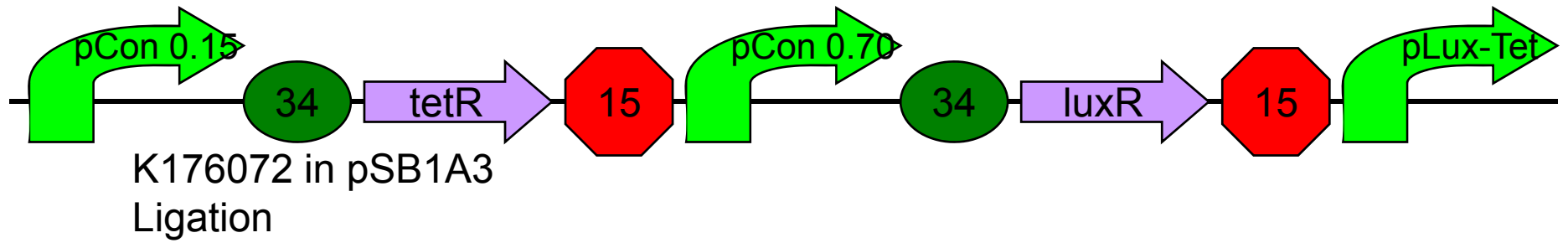

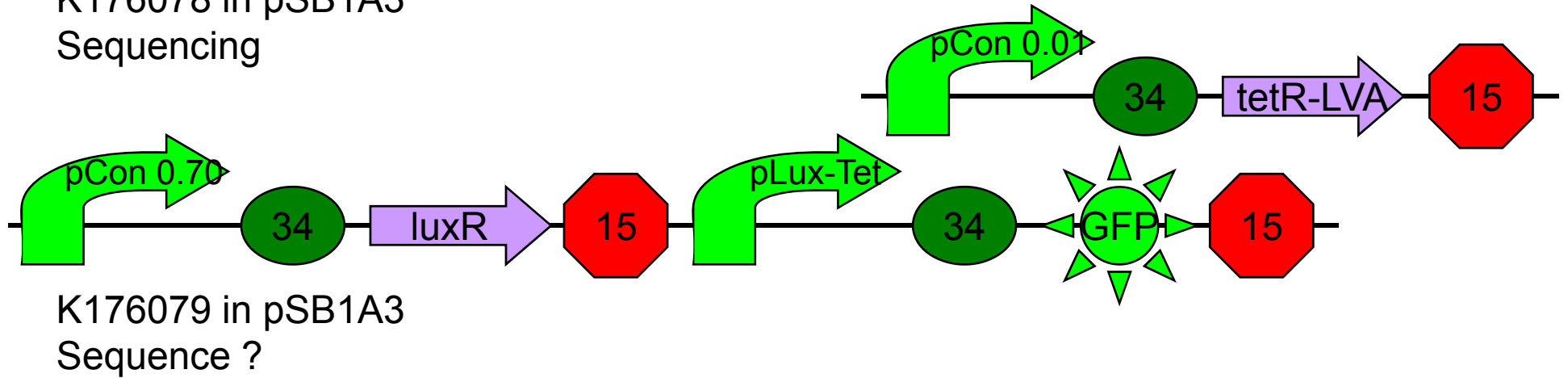
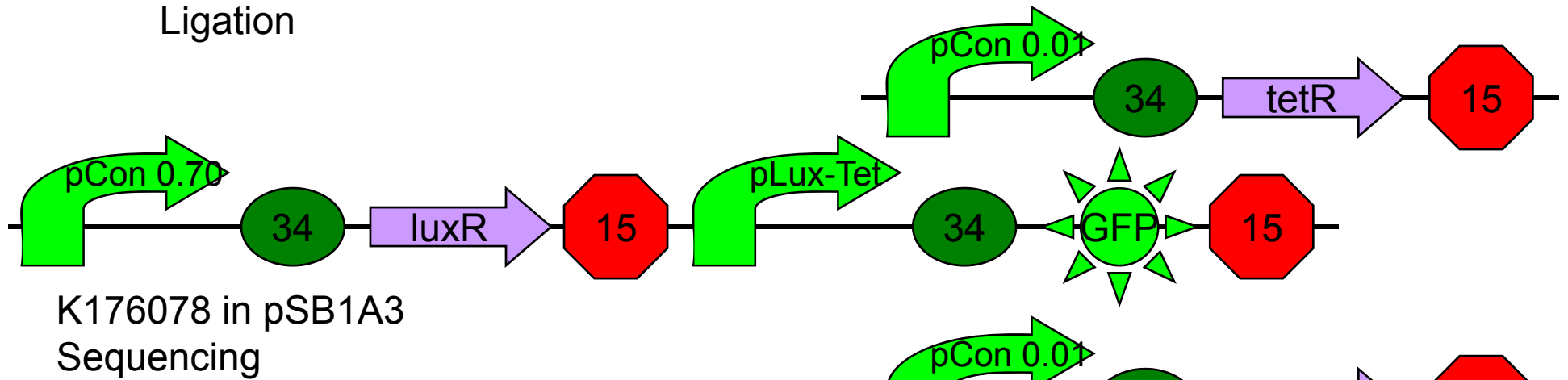
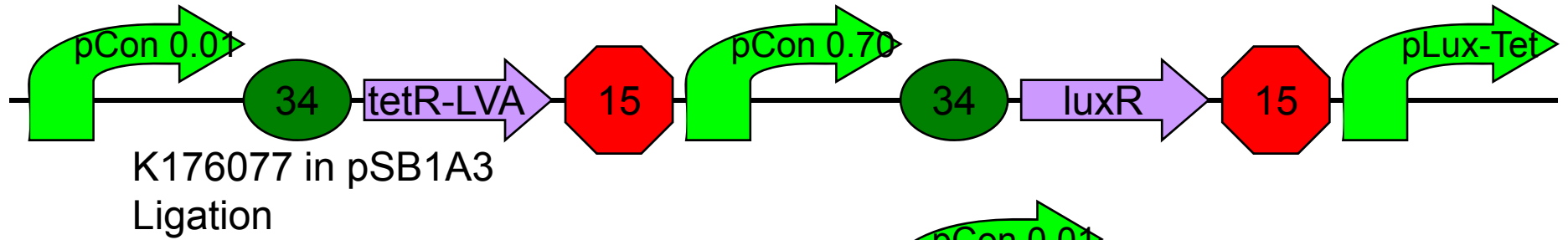
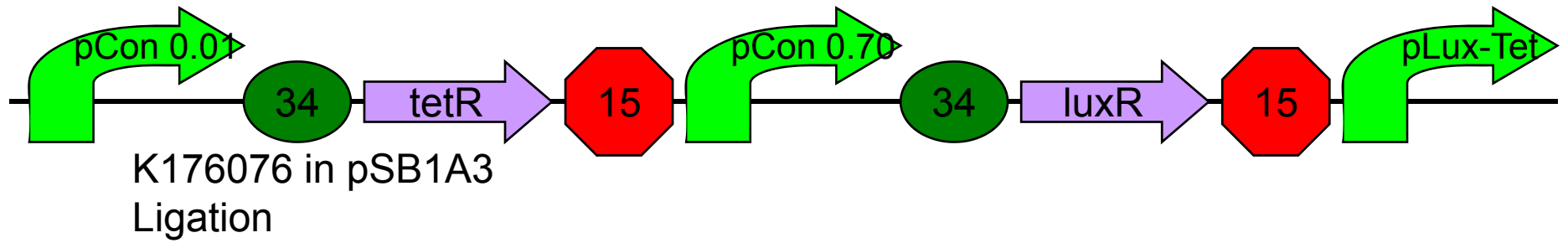



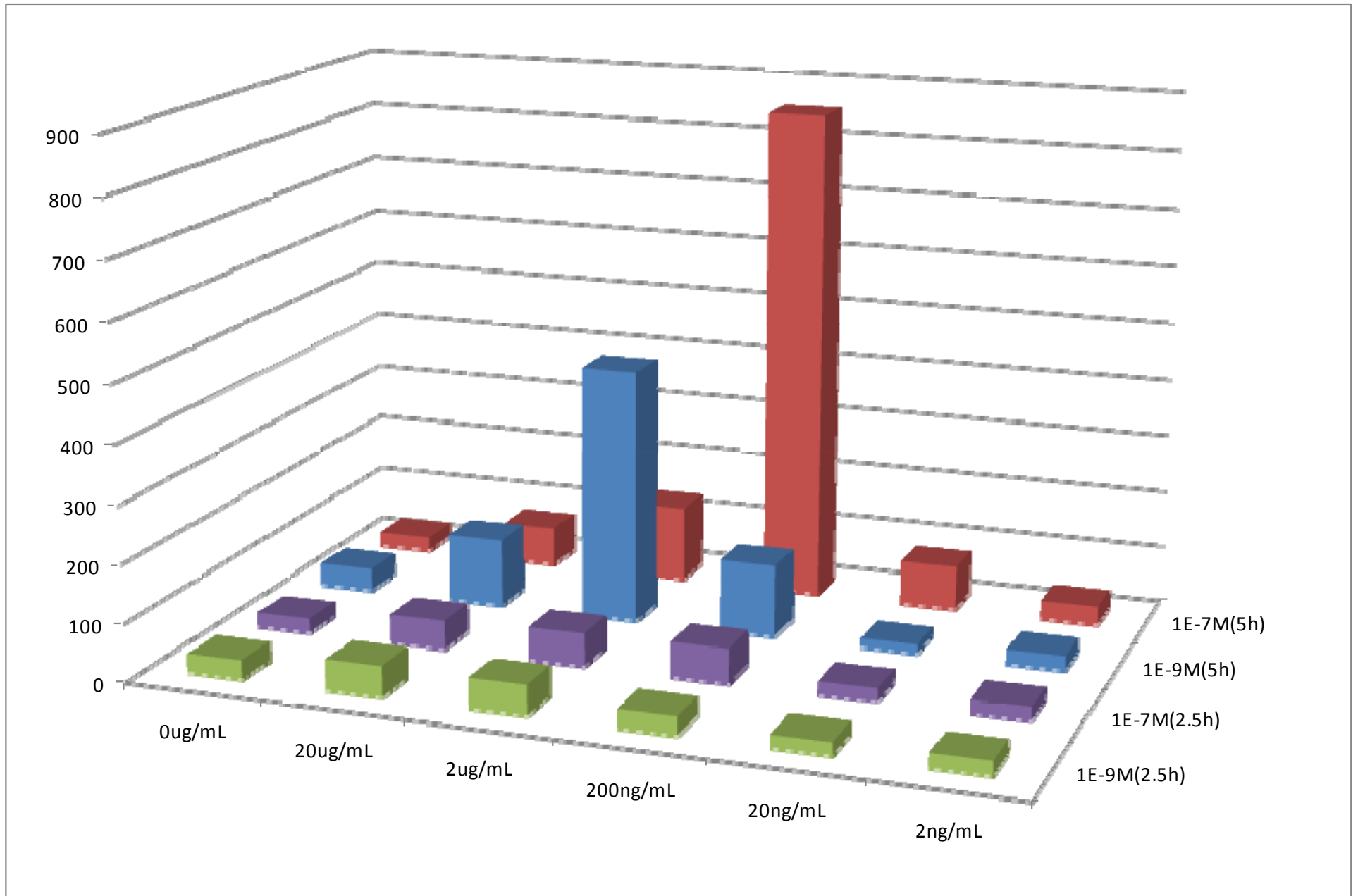

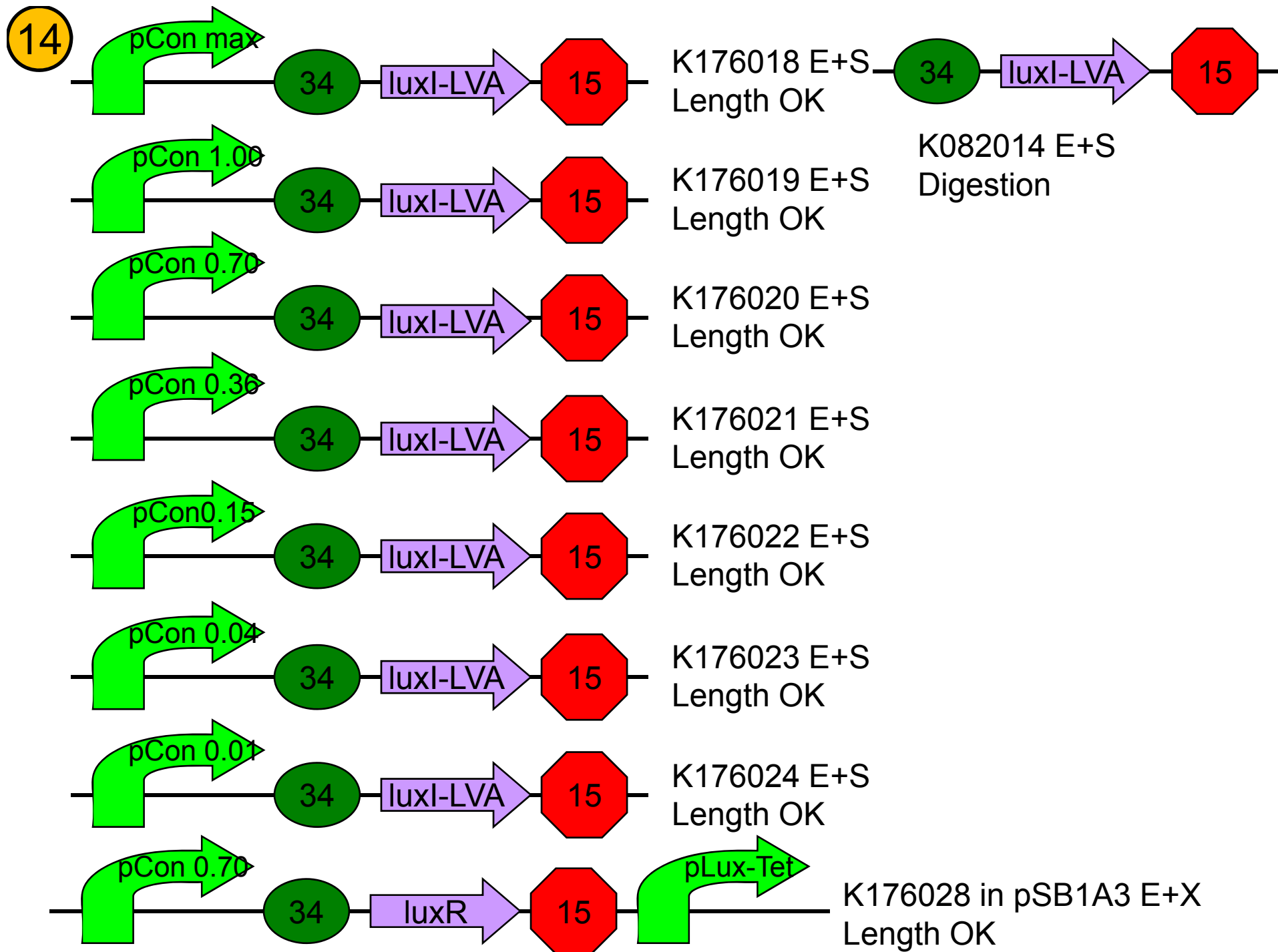

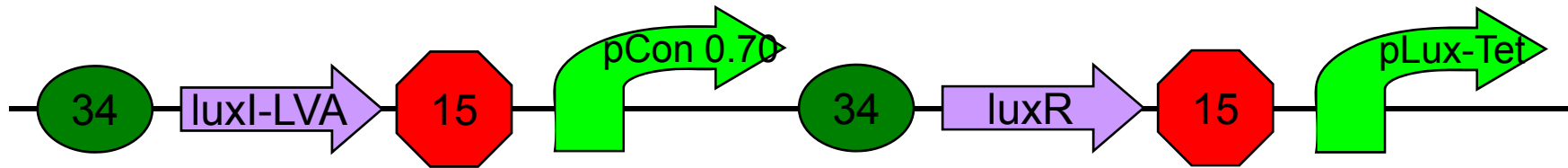

K176080 in pSB1A3  
Waiting

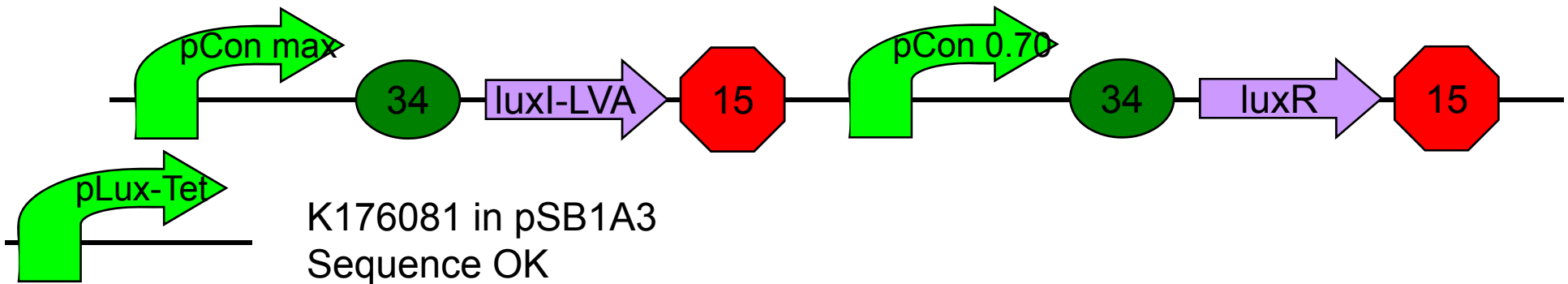

K176081 in pSB1A3  
Sequence OK

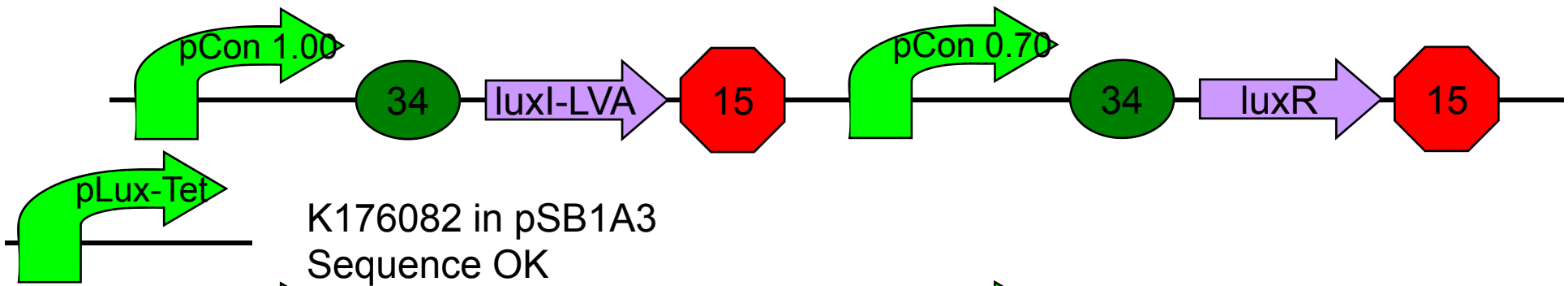

K176082 in pSB1A3  
Sequence OK

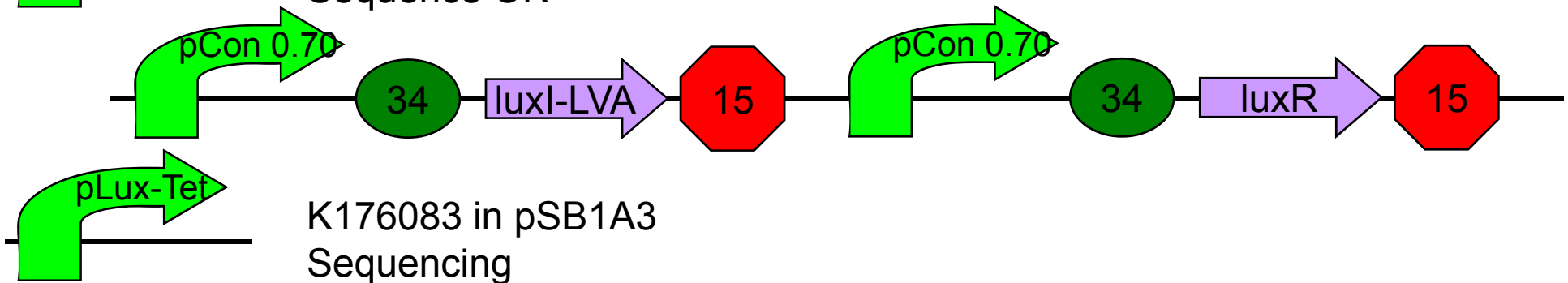

K176083 in pSB1A3  
Sequencing

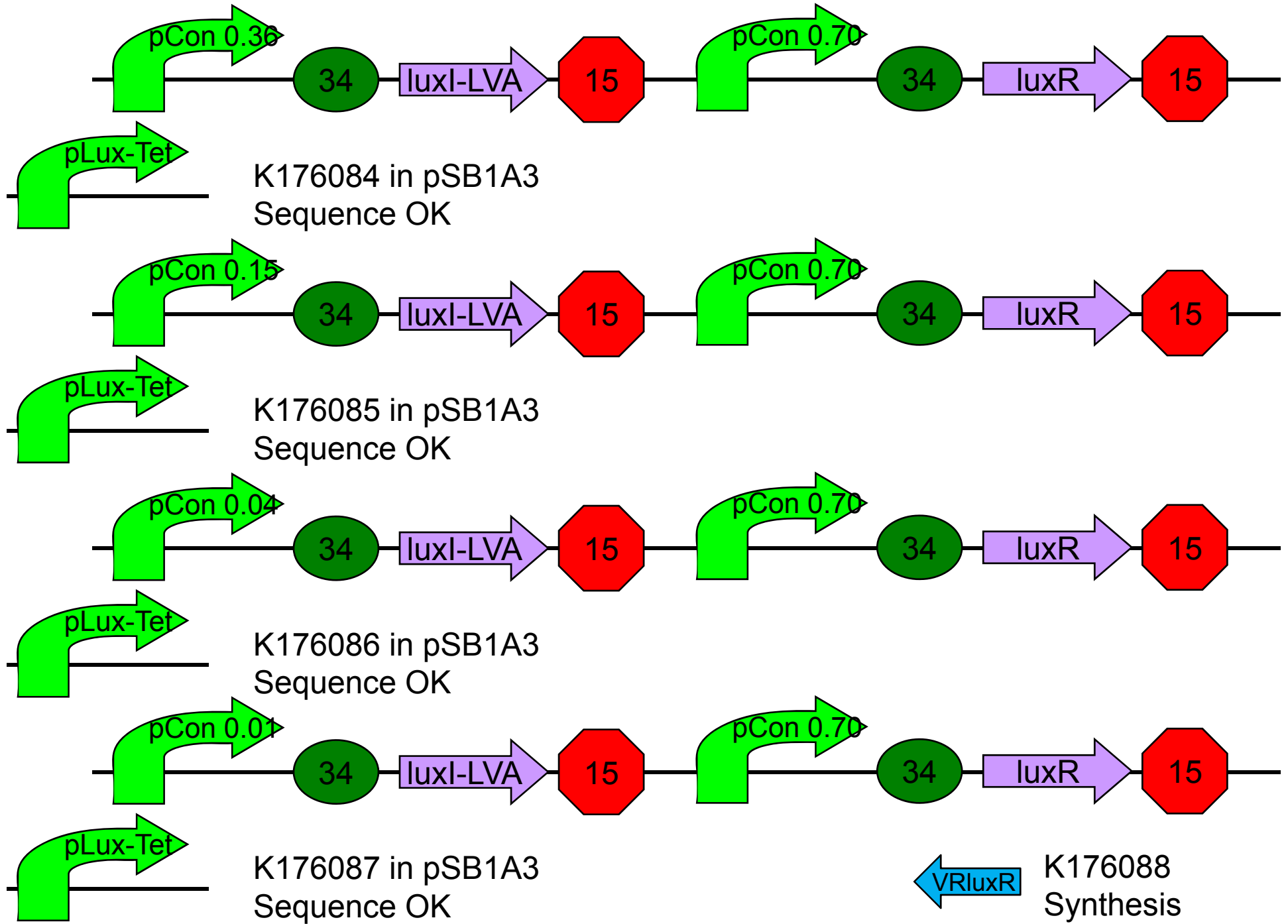



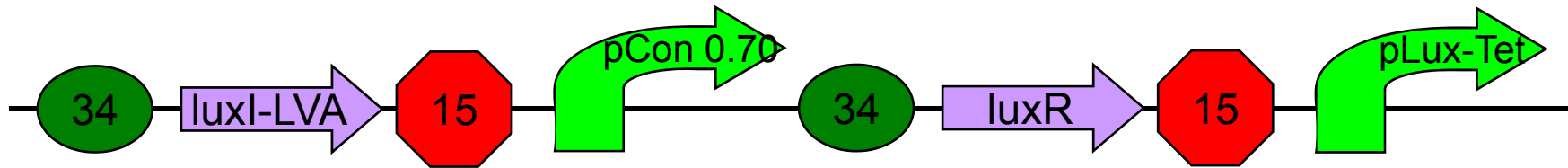

K176080 in pSB1A3 S+P  
Waiting

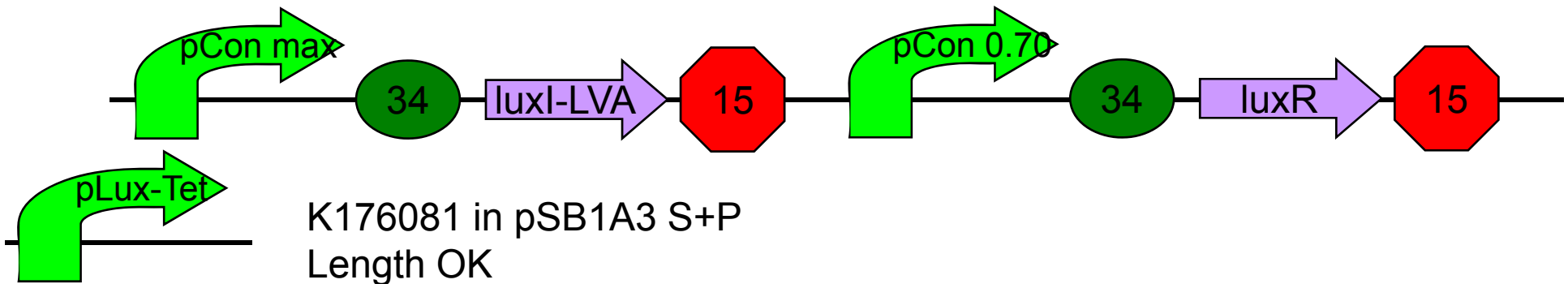

K176081 in pSB1A3 S+P  
Length OK

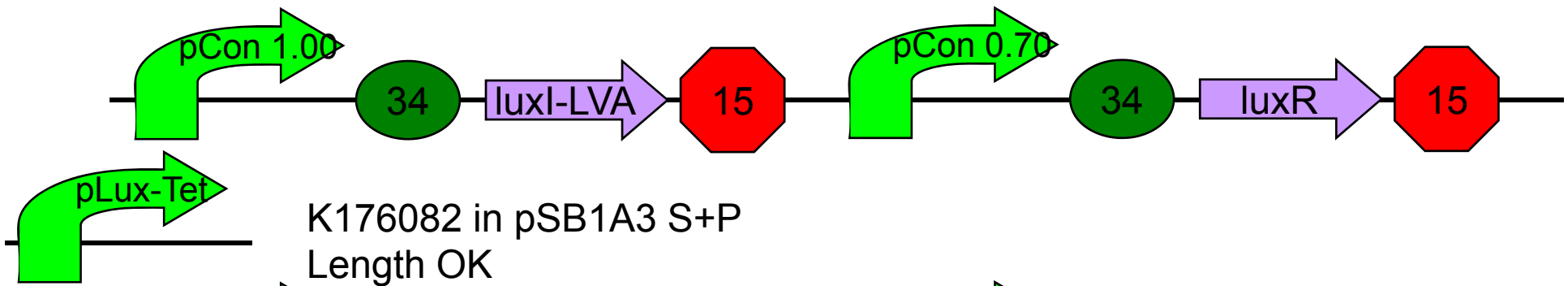

K176082 in pSB1A3 S+P  
Length OK

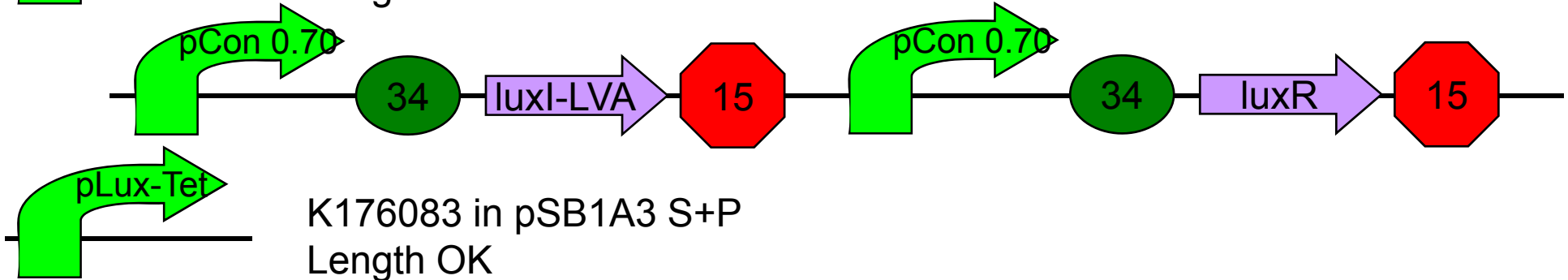

K176083 in pSB1A3 S+P  
Length OK

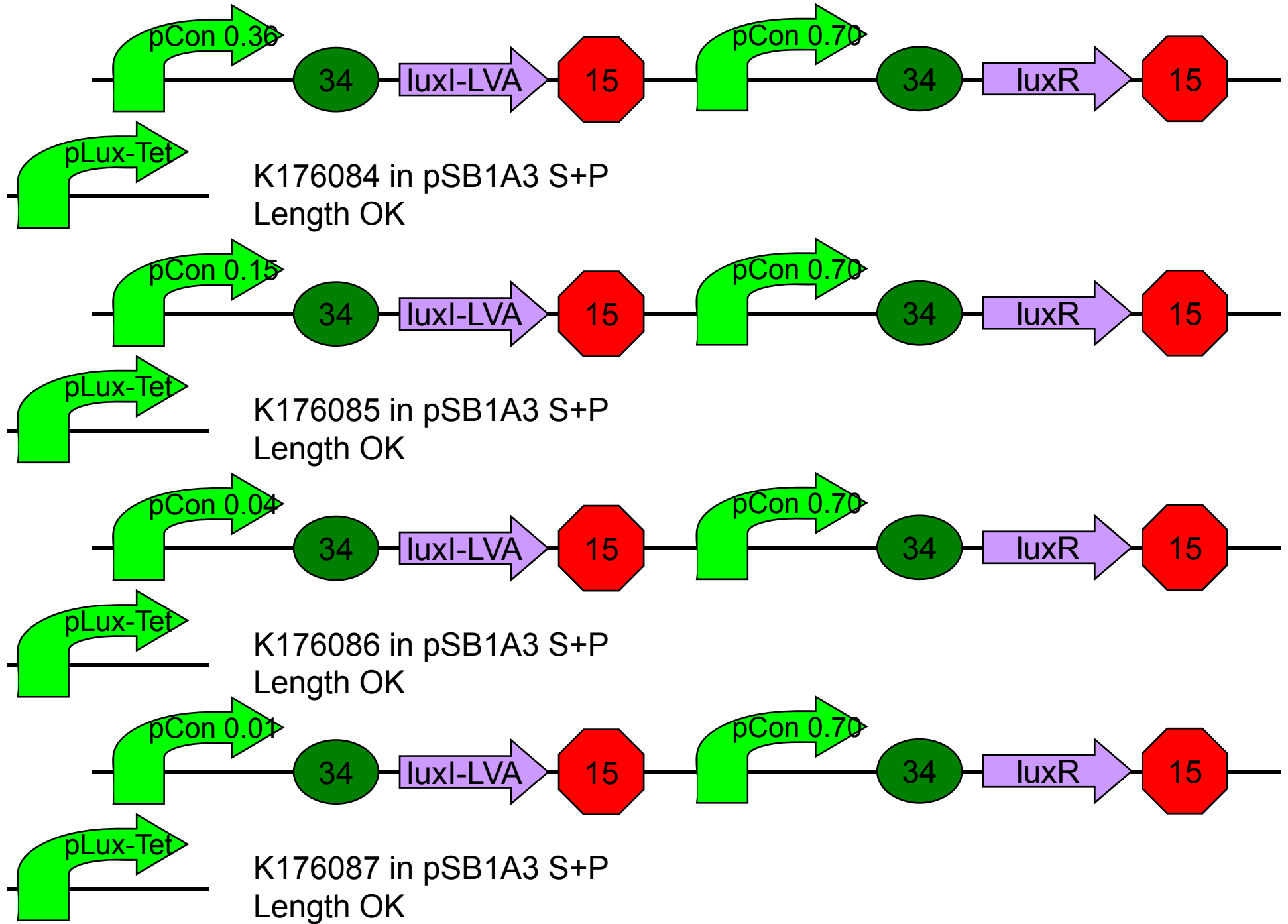

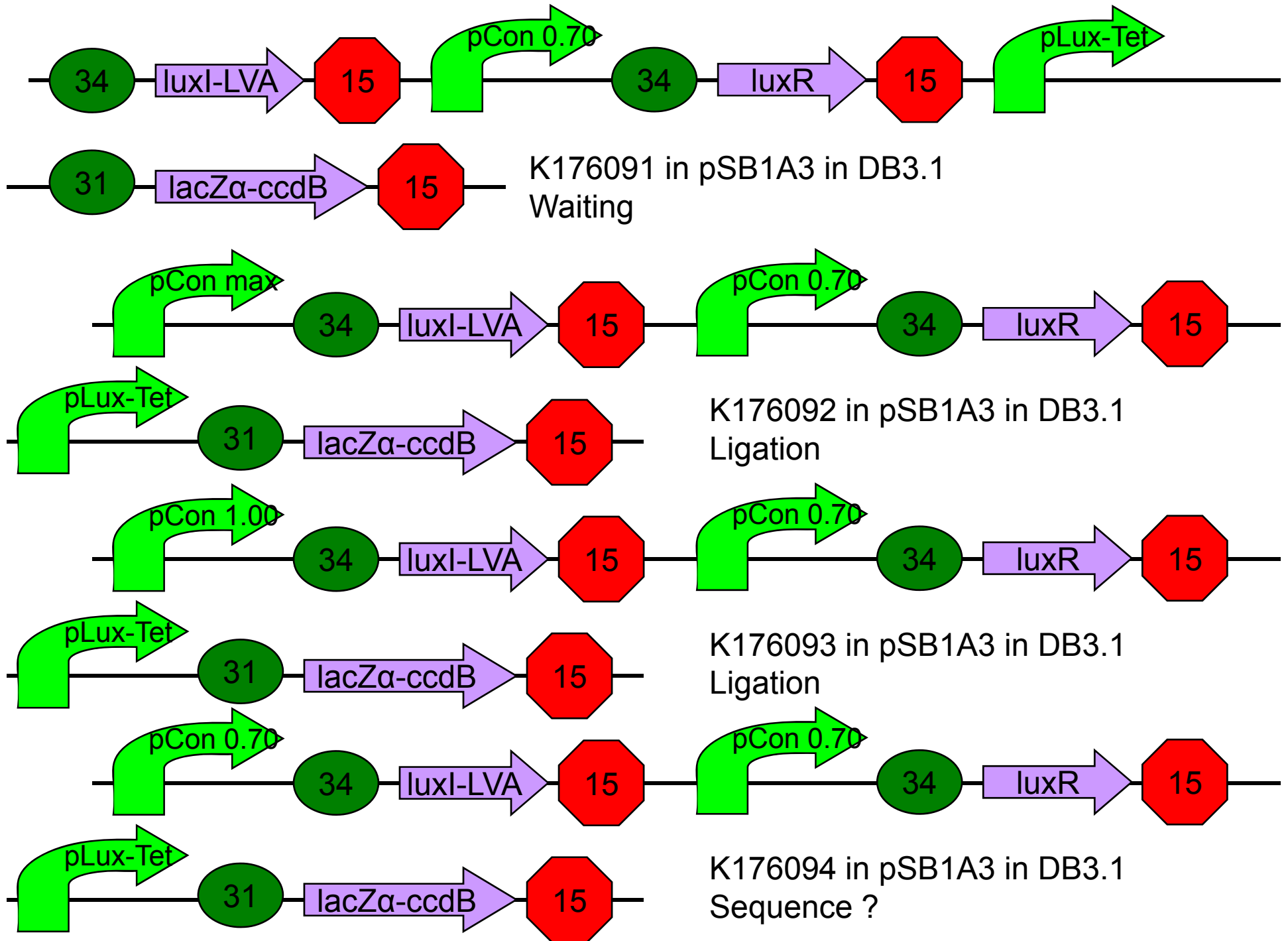

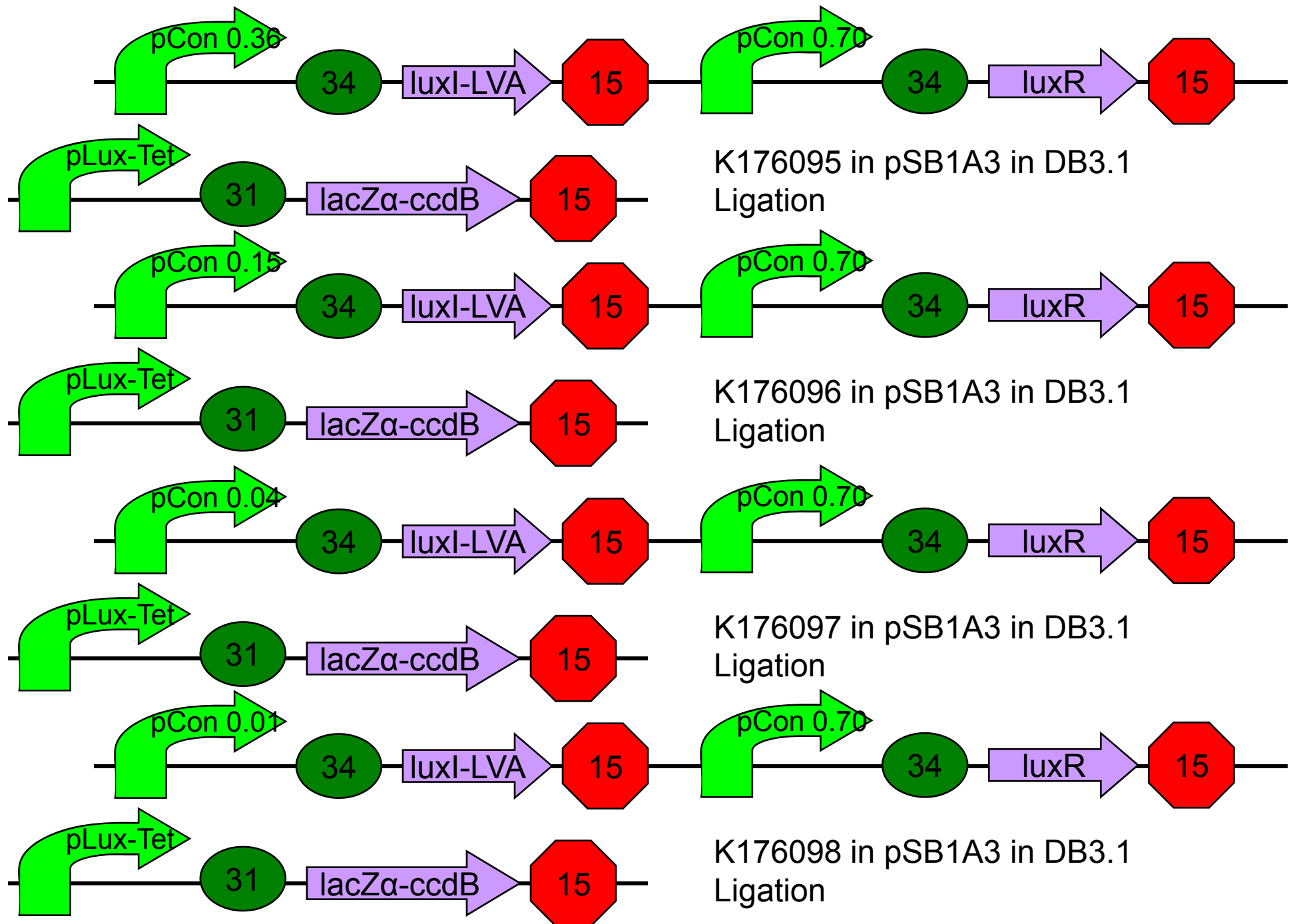

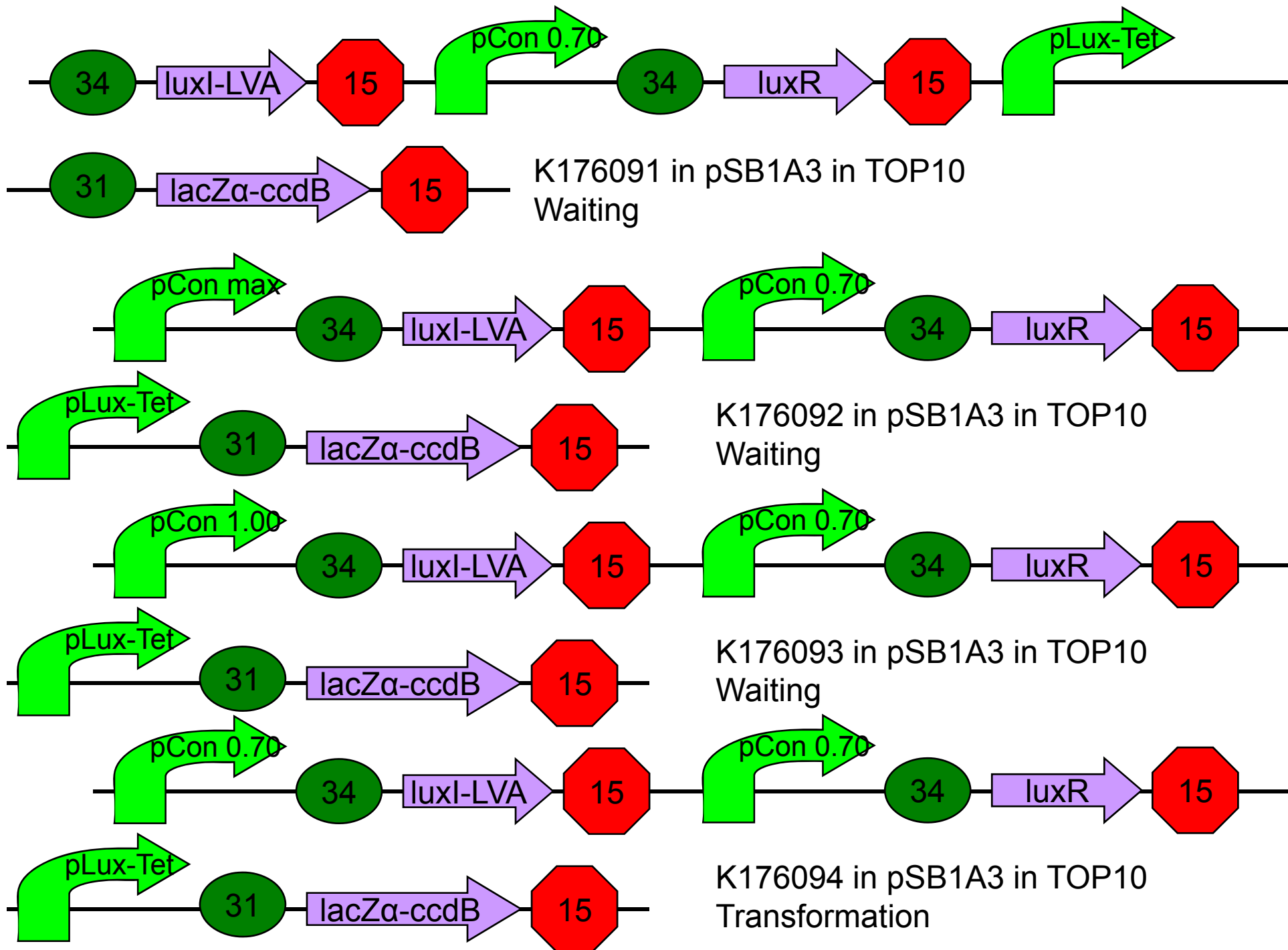

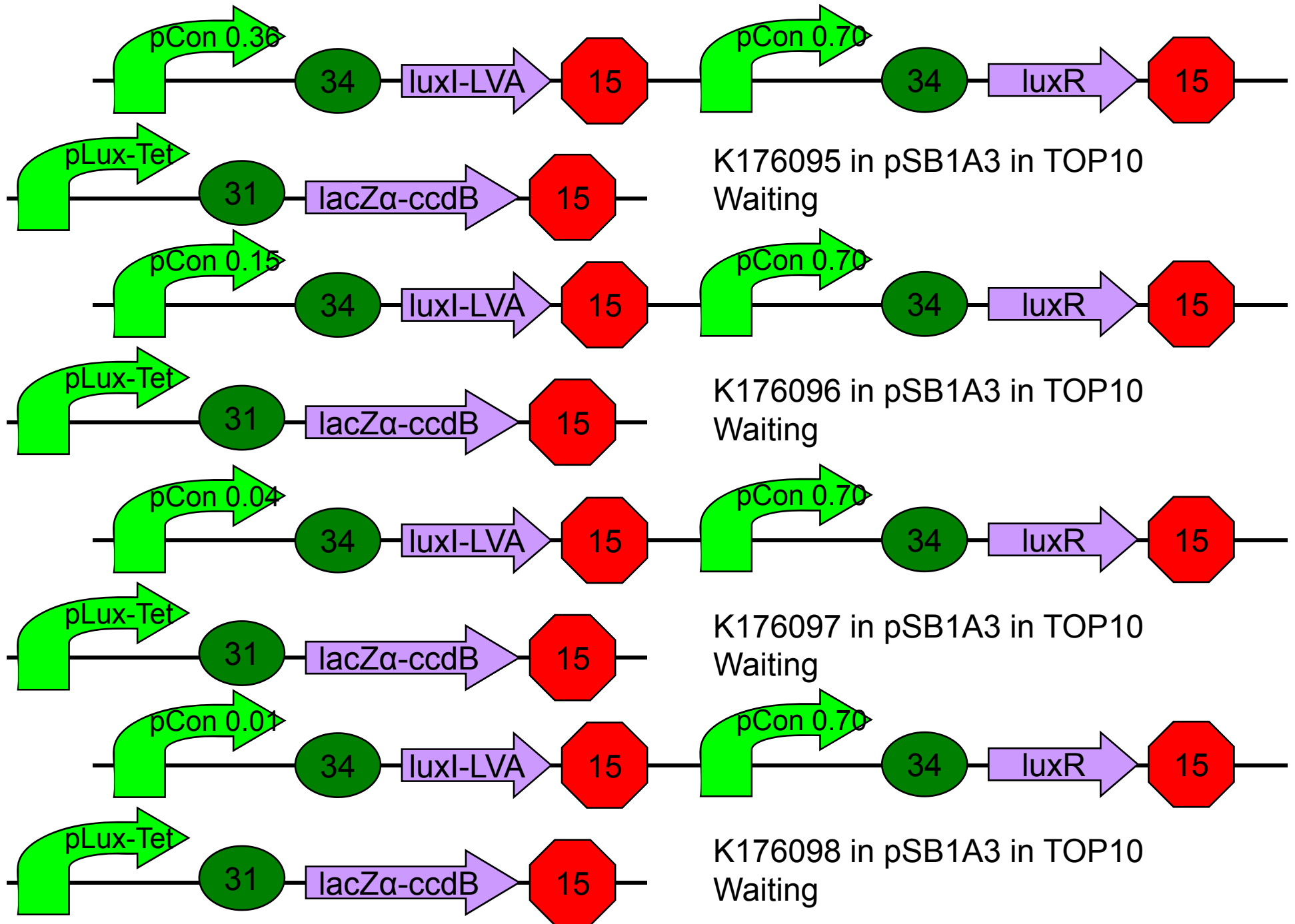

15

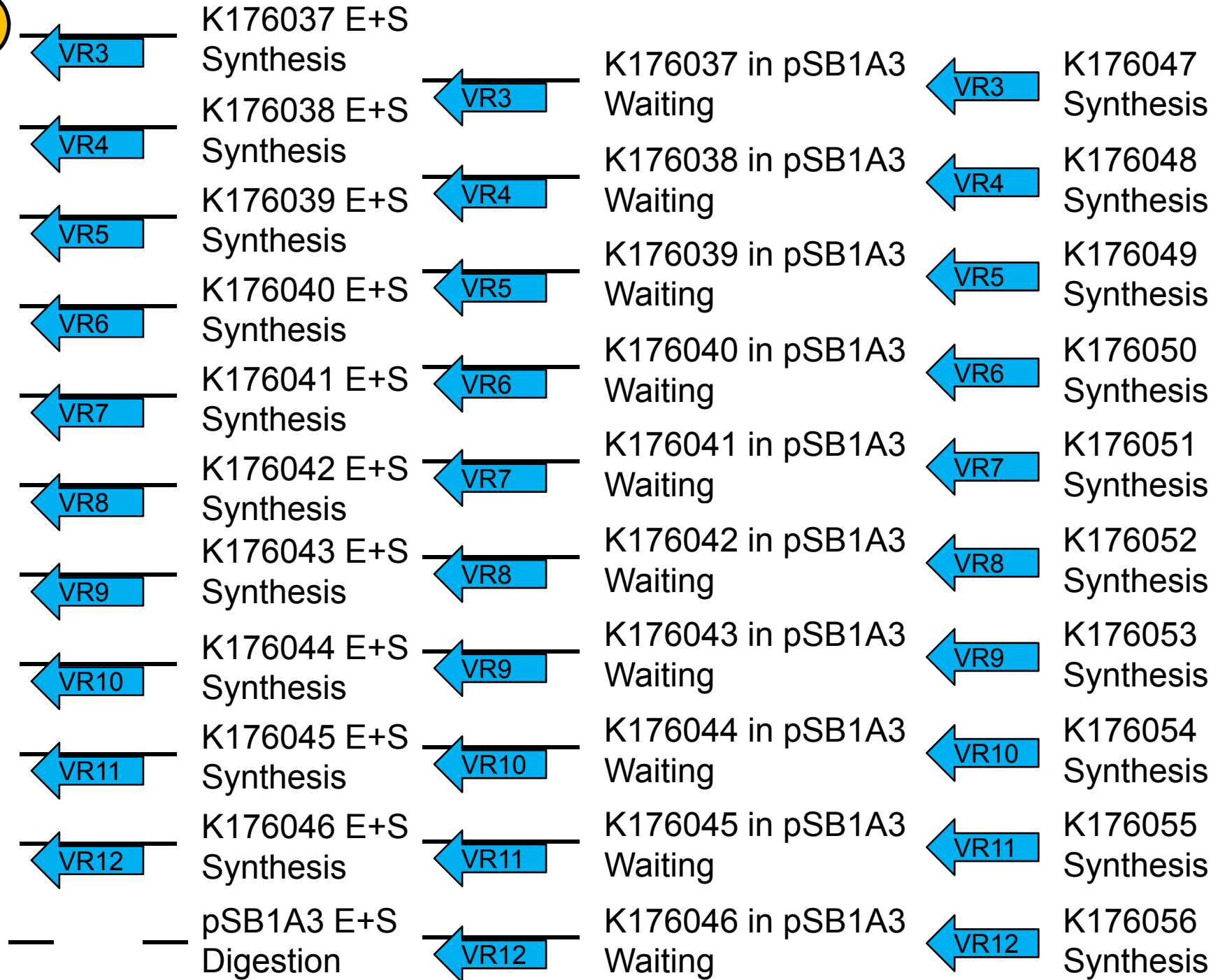

16

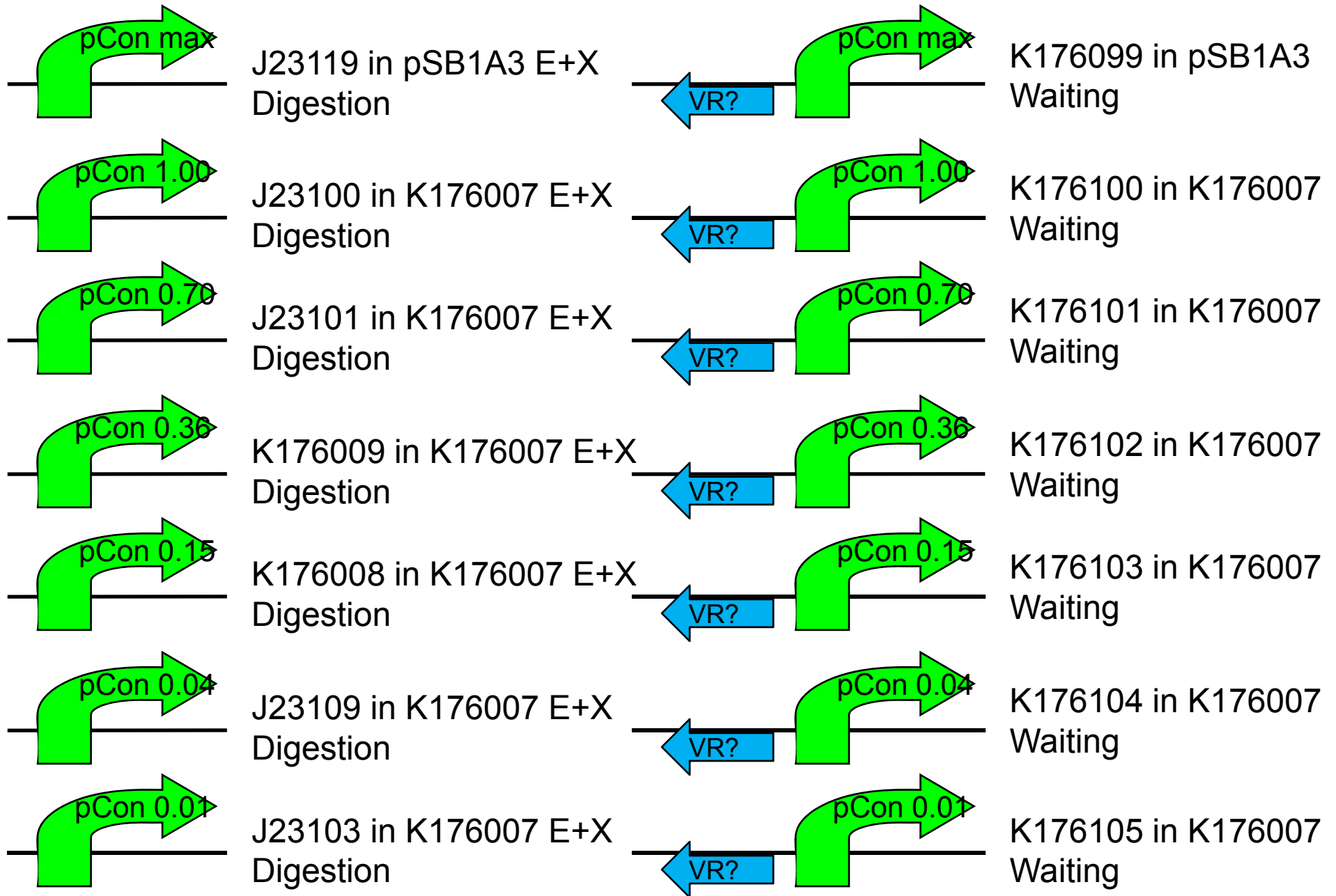



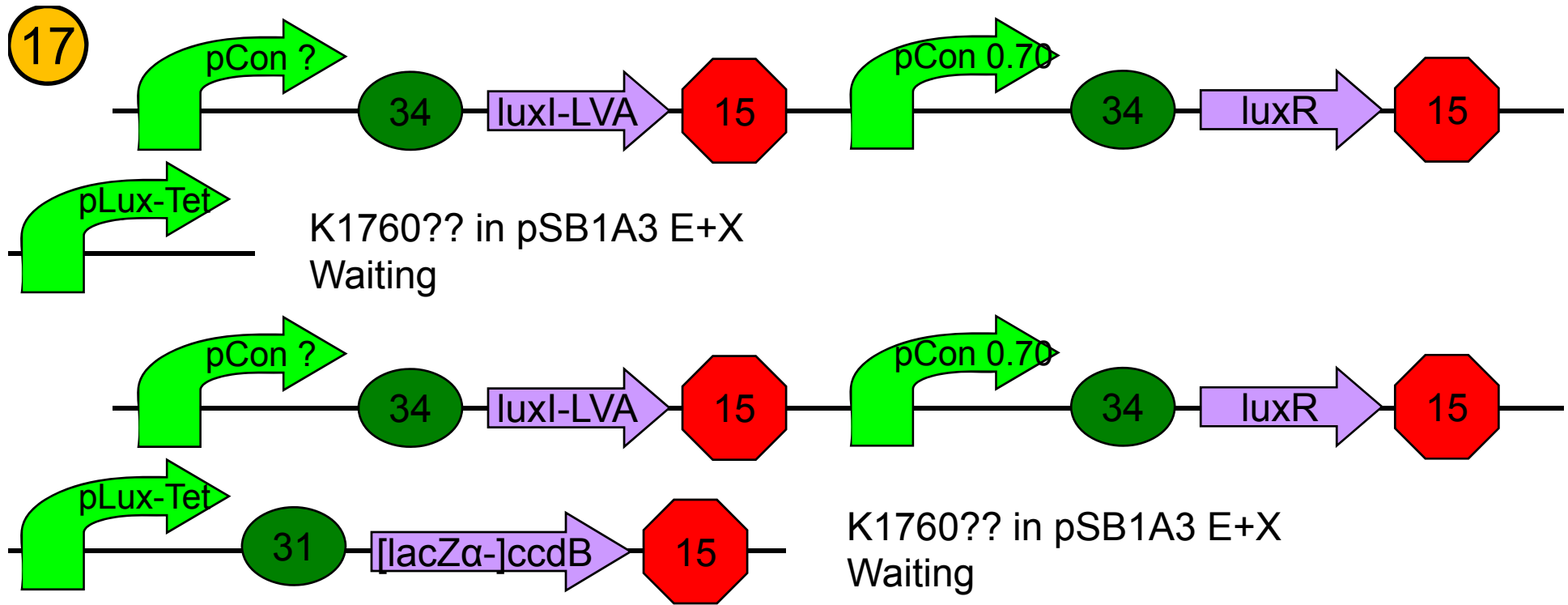

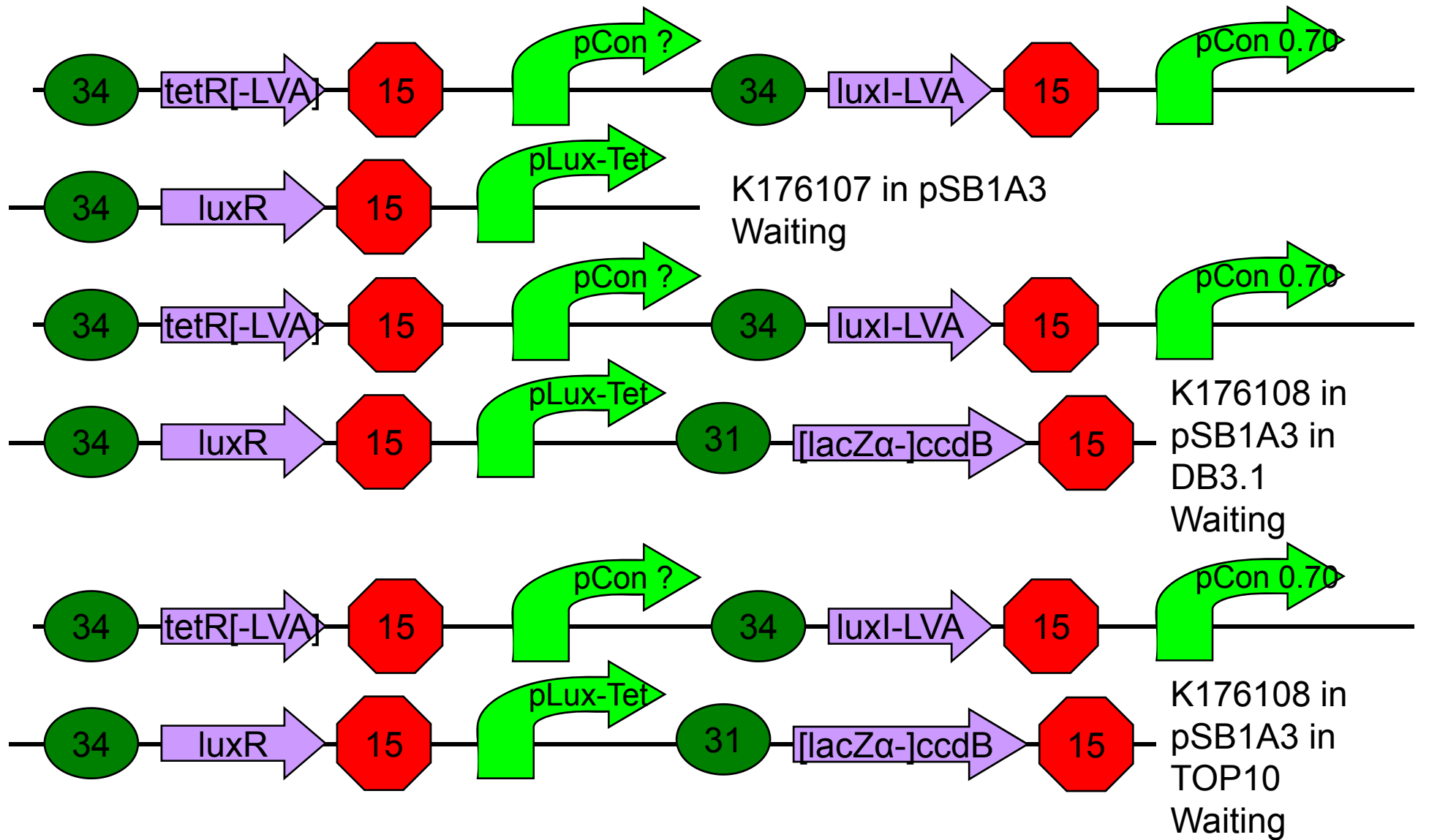

18

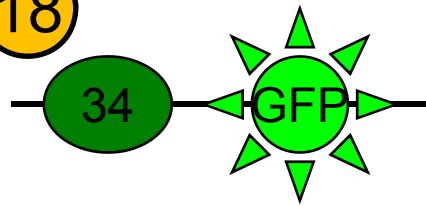

I13500 in pSB1A2  
Sequence OK

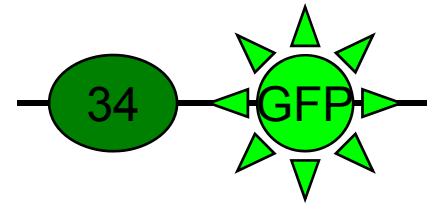

I13500 in pSB1A2 S+P  
Length OK

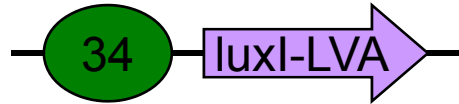

C0261 in pSB1A2  
Sequence OK

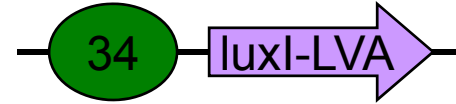

C0261 X+P  
Length OK

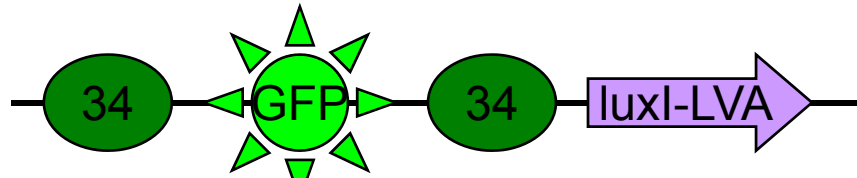

K176106 in pSB1A2  
Sequence OK

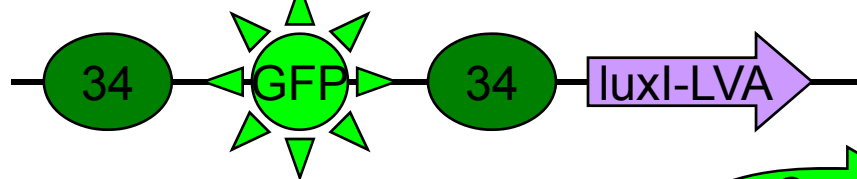

K176106 E+S  
Digestion

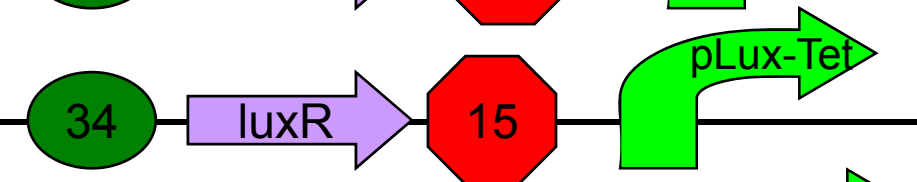
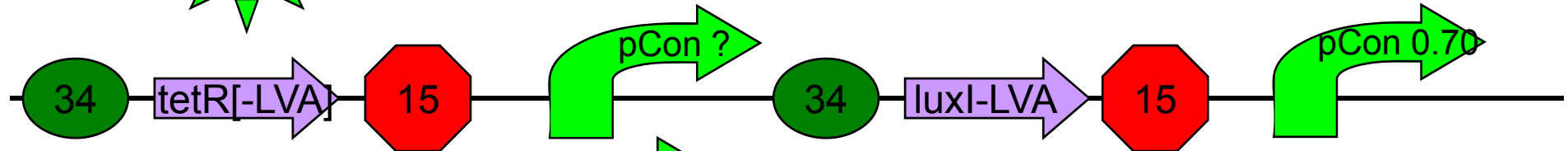

K176107 in pSB1A3 S+P  
Waiting

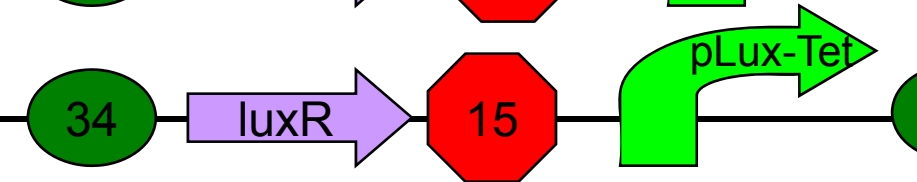
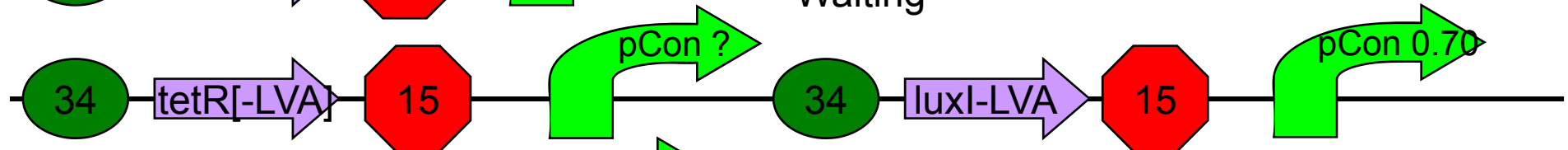

K176108 in  
pSB1A3 S+P  
Waiting

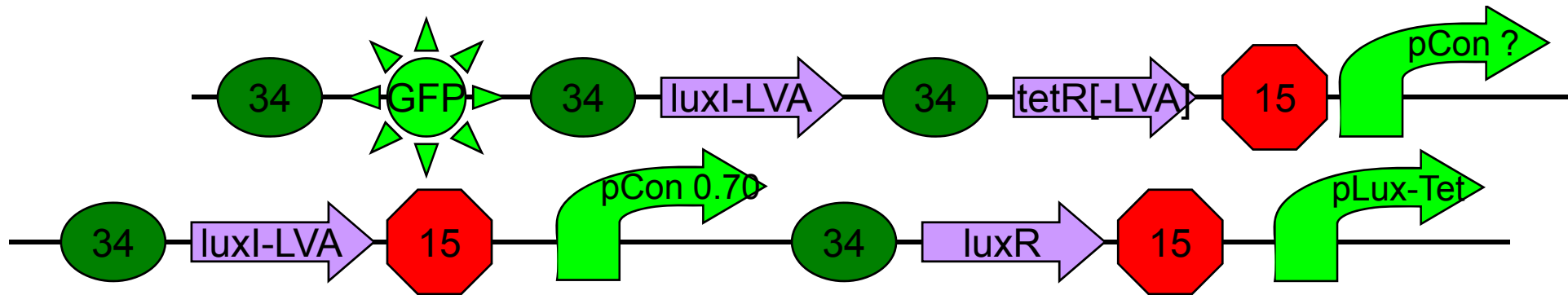

K176109 in pSB1A3  
Waiting

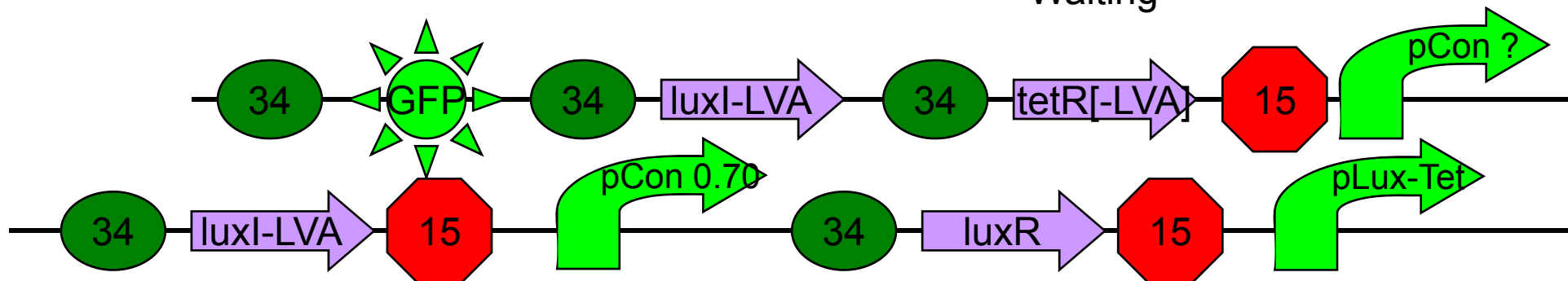

K176110 in pSB1A3 in DB3.1  
Waiting

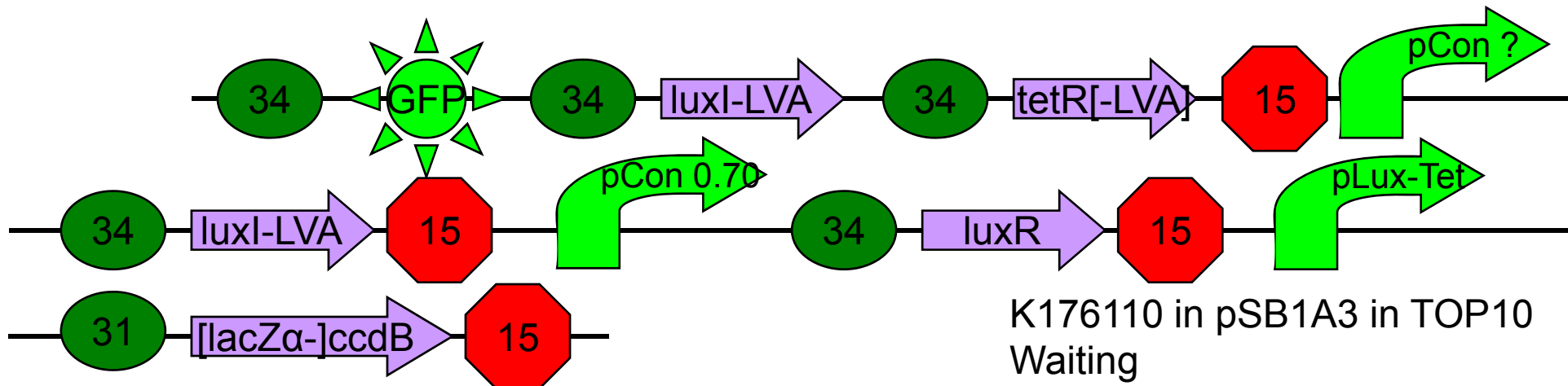

K176110 in pSB1A3 in TOP10  
Waiting





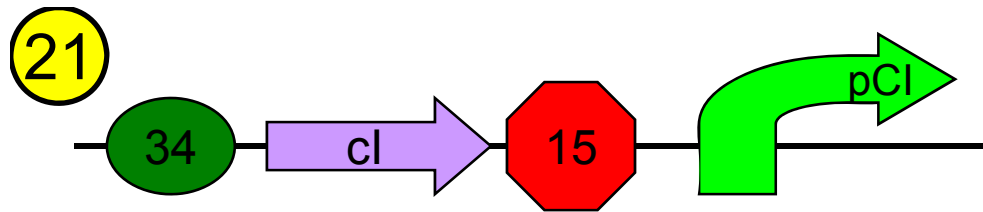

Q04510 in pSB2K3  
Sequencing

22

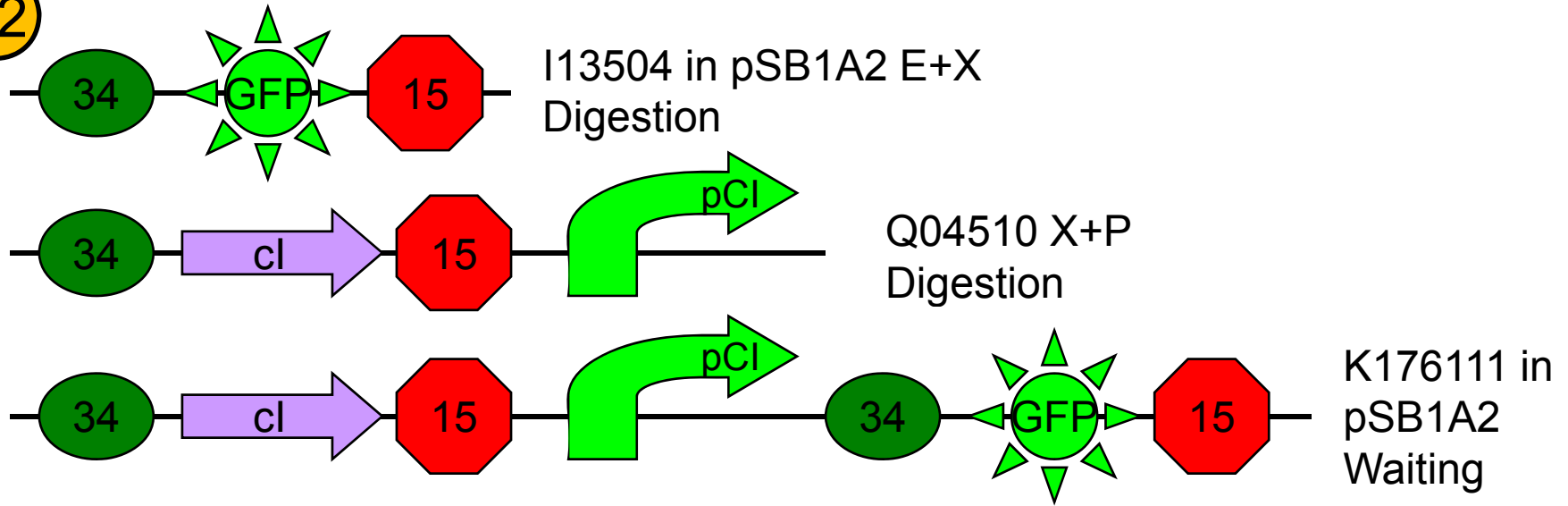



23

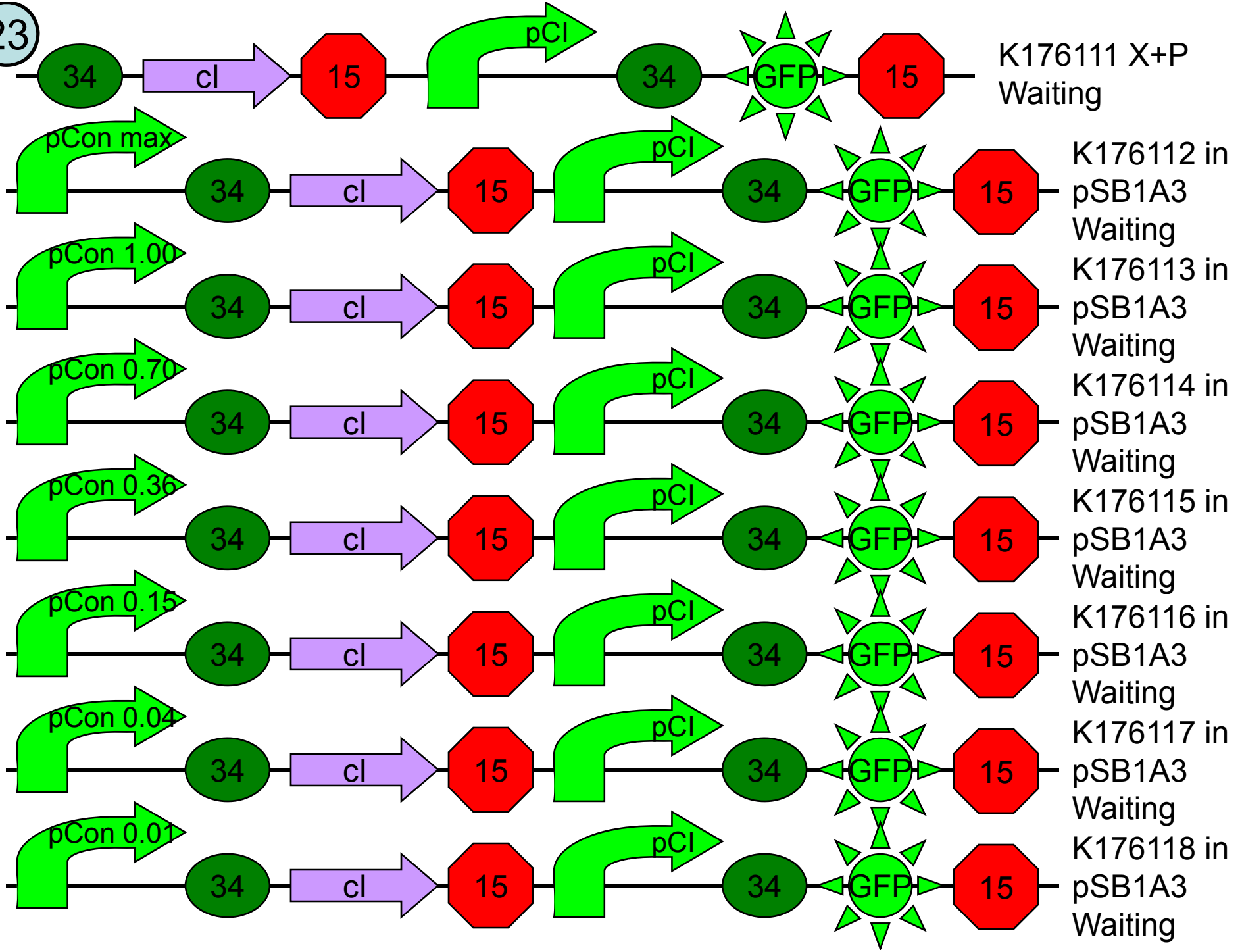

# USTC 2009 iGEM Team Parts

## Favorite USTC 2009 iGEM Team Parts

[Edit](#)

-?-	Name	Type	Description	Designer	Length
-----	------	------	-------------	----------	--------

## USTC 2009 iGEM Team Parts Sandbox

[Edit](#)

-?-	Name	Type	Description	Designer	Length
	BBa_K176000	Regulatory	pLux/Tet Hybrid Promoter: (LuxR+,TetR-)->PoPS	Danqian Liu, Chao Li, Hao Jiang	72
	BBa_K176001	Generator	PoPS->RBS+tetR(no LVA)+T	Chao Li,Danqian Liu,Hao Jiang	782
	BBa_K176002	Reporter	pLux/Tet(K176000)(LuxR+,TetR-)->RBS+GFP+T	Chao Li,Danqian Liu,Hao Jiang	955
	BBa_K176003	Coding	lacZalpha-ccdB coding sequence	Zongxiao He, Hao Jiang	480
	BBa_K176004	Generator	pCon max(J23119)->RBS+luxR+T	Chao Li,Danqian Liu,Hao Jiang	979
	DDa_K176005	Reporter	pCon max(J23119)->RBS+GFP+T	Chao Li,Danqian Liu,Hao Jiang	910
	BBa_K176006	Generator	PoPS->RBS+tetR-LVA+T	Chao Li,Danqian Liu,Hao Jiang	840
W	BBa_K176007	Plasmid_Backbone	pSB1A3 with the suffix of J61002 (mRFP)	Hao Jiang, Danqian Liu, Chao Li	3026
	BBa_K176008	Regulatory	constitutive promoter family member J23115 actual sequence	Hao Jiang, Danqian Liu, Chao Li	35
	BBa_K176009	Regulatory	constitutive promoter family member J23107 actual sequence	Hao Jiang, Danqian Liu, Chao Li	35
	BBa_K176010	Translational_Unit	PoPS->RBS+ccdB->PoPS	Zongxiao He, Hao Jiang	324
	BBa_K176011	Reporter	pCon 1.00(J23100)->RBS+GFP+T	Chao Li, Danqian Liu, Hao Jiang	918
	BBa_K176012	Reporter	pCon 0.70(J23101)->RBS+GFP+T	Chao Li, Danqian Liu, Hao Jiang	918
	BBa_K176013	Reporter	pCon 0.36(K176009)->RBS+GFP+T	Chao Li, Danqian Liu, Hao Jiang	918
	BBa_K176014	Reporter	pCon 0.15(K176008)->RBS+GFP+T	Chao Li, Danqian Liu, Hao Jiang	918
	BBa_K176015	Reporter	pCon 0.04(J23109)->RBS+GFP+T	Chao Li, Danqian Liu, Hao Jiang	918
	BBa_K176016	Reporter	pCon 0.01(J23103)->RBS+GFP+T	Chao Li, Danqian Liu, Hao Jiang	918
	BBa_K176017	Reporter	pCI(R0051)(lambda Cl-)->RBS+GFP+T	Chao Li, Danqian Liu, Hao Jiang	932
	BBa_K176018	Signalling	pCon max(J23119)->RBS+lux-LVA+T	Danqian Liu, Chao Li, Hao Jiang	841
	BBa_K176019	Signalling	pCon 1.00(J23100)->RBS+lux-LVA+T	Danqian Liu, Chao Li, Hao Jiang	841
	BBa_K176020	Signalling	pCon 0.70(J23101)->RBS+lux-LVA+T	Danqian Liu, Chao Li, Hao Jiang	841
	BBa_K176021	Signalling	pCon 0.36(K176009)->RBS+lux-LVA+T	Danqian Liu, Chao Li, Hao Jiang	841
	BBa_K176022	Signalling	pCon 0.15(K176008)->RBS+lux-LVA+T	Danqian Liu, Chao Li, Hao Jiang	841
	BBa_K176023	Signalling	pCon 0.04(J23109)->RBS+lux-LVA+T	Danqian Liu, Chao Li, Hao Jiang	841
	BBa_K176024	Signalling	pCon 0.01(J23103)->RBS+lux-LVA+T	Danqian Liu, Chao Li, Hao Jiang	841

# Measurement

- Strain
  - TOP10
  - DH5 $\alpha$
  - MG1655
  - MDS 42 recA Blue
- Plasmid
- Medium
  - LB
  - M9
    - Minimal
    - Supplemented
  - EZ Rich Define
  - pH-buffered TBK
  - pH-buffered LBK
- pH
- Temperature
  - 37°C
  - 30°C
  - 34°C
- Pre-warm
- Shake
- Dilution
- Wash

[http://openwetware.org/wiki/M9\\_medium](http://openwetware.org/wiki/M9_medium)

[http://openwetware.org/wiki/M9\\_medium/minimal](http://openwetware.org/wiki/M9_medium/minimal)

[http://openwetware.org/wiki/M9\\_medium/supplemented](http://openwetware.org/wiki/M9_medium/supplemented)

[http://openwetware.org/wiki/Neidhardt\\_EZ\\_Rich\\_Defined](http://openwetware.org/wiki/Neidhardt_EZ_Rich_Defined)

<http://www.genome.wisc.edu/resources/protocols/ezmedium.htm>

# Emergent Properties of Reduced-Genome *Escherichia coli*

György Pósfai,<sup>1,2\*</sup> Guy Plunkett III,<sup>2,3,4</sup> Tamás Fehér,<sup>1</sup> David Frisch,<sup>2,4</sup> Günther M. Keil,<sup>5</sup> Kinga Umenhoffer,<sup>1</sup> Vitaliy Kolisnychenko,<sup>1</sup>† Buffy Stahl,<sup>2</sup> Shamik S. Sharma,<sup>6</sup>‡ Monika de Arruda,<sup>2</sup> Valerie Burland,<sup>2,3</sup> Sarah W. Harcum,<sup>7</sup> Frederick R. Blattner<sup>2,3,4\*</sup>

With the use of synthetic biology, we reduced the *Escherichia coli* K-12 genome by making planned, precise deletions. The multiple-deletion series (MDS) strains, with genome reductions up to 15%, were designed by identifying nonessential genes and sequences for elimination, including recombinogenic or mobile DNA and cryptic virulence genes, while preserving good growth profiles and protein production. Genome reduction also led to unanticipated beneficial properties: high electroporation efficiency and accurate propagation of recombinant genes and plasmids that were unstable in other strains. Eradication of stress-induced transposition evidently stabilized the MDS genomes and provided some of the new properties.

*Escherichia coli* K-12 is one of the best understood and most thoroughly analyzed organisms and is the platform of choice for genetic, biochemical, and metabolic simulation research. Commercially, it is used for production of metabolites such as amino acids and proteins of therapeutic or commercial interest. K-12 is also gaining ground for production of DNA for gene therapy, DNA vaccines, and interference RNA. The genomes of two closely related K-12 strains, MG1655 and W3110, have been sequenced (1–3), and 87% of their genes have functional assignments (4).

mobile DNA elements that mediate recombination events such as transposition and horizontal gene transfer, including insertion sequence (IS) elements, transposases, defective phages, integrases, and site-specific recombinases (5). Multiple elements also provide DNA sequence repeats that mediate inversions, duplications, and deletions by homologous recombination even without transposase. To stabilize the genome and streamline metabolism, these elements must be deleted and unwanted functions removed, such as those specific for human hosts or particular envi-

ated by the phage lambda Red system. Beginning with prototype strain MDS12 (9), “scarless” deletions were made by removing the targeted segment and resealing the genome so that markers used in the construction were eliminated. Resulting strains were tested for robust growth on minimal medium, and deletions were serially accumulated into a single strain by P1 transduction. Deletion endpoints were verified by sequencing and by DNA microarray hybridization (Fig. 1) (8). Physical characteristics of the MDS strains are summarized in Table 1; deletion endpoints are in table S1, deleted genes in table S3, and strain request information in (8). Generation of double-strand breaks (DSBs) in each deletion process might have induced error-prone repair, but experiments designed to detect this showed that a single transient break would have no detectable effect on the accumulation of point mutations.

MDS39, the first in the series designed to be IS-free, was examined by genomic DNA hybridization to NimbleGen genome scanning microarrays, which included IS elements, phages, and plasmids absent from K-12 (8) as well as the K-12 genomic sequence in the form of 24-base oligonucleotides tiled about every 50 bases on both strands. Alarming, we found five unexpected copies of IS that had transposed to new locations (8) since the project began

# GFP (PoPS)

- Fluorospectrophotometer
- Plate Reader
- Flow Cytometer (FACS)
- Blotting
  - Northern
  - Western
- Realtime RT-PCR

- <http://partsregistry.org/Measurement>
- [http://openwetware.org/wiki/The\\_BioBricks\\_Foundation:Standards/Technical/Measurement](http://openwetware.org/wiki/The_BioBricks_Foundation:Standards/Technical/Measurement)
- [http://openwetware.org/wiki/Standardized\\_GFP\\_quantification](http://openwetware.org/wiki/Standardized_GFP_quantification)
- Engineering the interface between cellular chassis (Barry Canton PhD thesis)
- Applying engineering principles to the design and construction of transcriptional devices (Reshma P. Shetty PhD thesis)

**STEP 1:** Streak 3 plates



A: TOP10  
 B: BBa\_I20260  
 C: Your promoter!

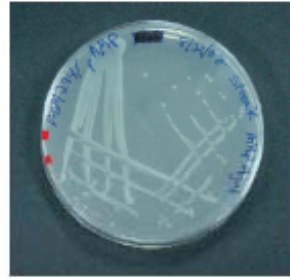

**STEP 2:** Pick 3 colonies from each plate to start overnight cultures in Supplemented M9 Media at 37 C (9 tubes)



TOP10  
 BBa\_I20260  
 Your Promoter



37C



16 hours

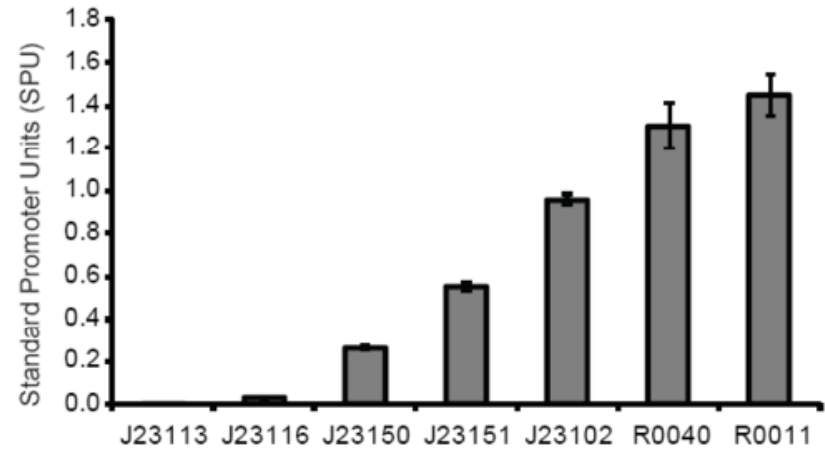

**Standard Promoter Units**

**STEP 3:** Dilute 1/100 into fresh, pre-warmed media incubate at 37C (9 tubes)

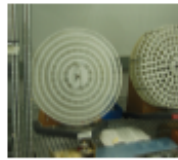
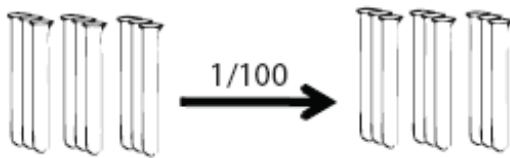

37C

**STEP 4:** After 3 hours measure GFP and OD



3 hours



GFP

OD

**STEP 5:** After another half hour measure GFP and OD again



1/2 hour



GFP

OD

2006 Berkeley **J23100~J23119**  
 Reported activities of the promoters are given as the relative fluorescence of these plasmids in strain TG1 grown in LB media to **saturation**. See part J61002 for details on their use.



# AHL

- Rapid Screening of Quorum-Sensing Signal N-Acyl Homoserine Lactones by an In Vitro Cell-Free Assay
- Detection of N-acylhomoserine lactones in lung tissues of mice infected with *Pseudomonas aeruginosa*
- Detecting and characterizing N-acyl-homoserine lactone signal molecules by thin-layer chromatography
- Detection of N-acyl homoserine lactones using a *traI-luxCDABE*-based biosensor as a high-throughput screening tool
- On-line high-performance liquid chromatography-mass spectrometric detection and quantification of N-acylhomoserine lactones, quorum sensing signal molecules, in the presence of biological matrices
- Detection of quorum-sensing N-acyl homoserine lactone signal molecules by bacterial biosensors

# CcdB & LacZ $\alpha$

- Programmed population control by cell–cell communication and regulated killing
- A synthetic *Escherichia coli* predator–prey ecosystem
- LacZ $\alpha$ 
  - X-gal
  - ONPG
    - <http://parts.mit.edu/igem07/index.php/USTC/BetaGalactosidaseAssay>

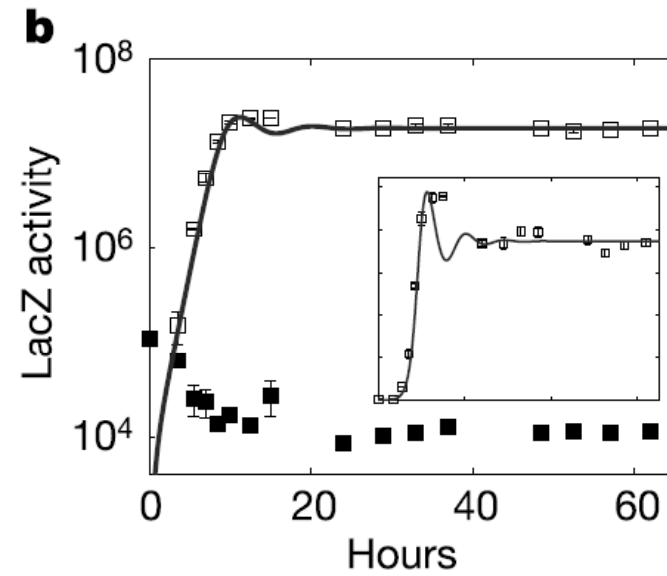
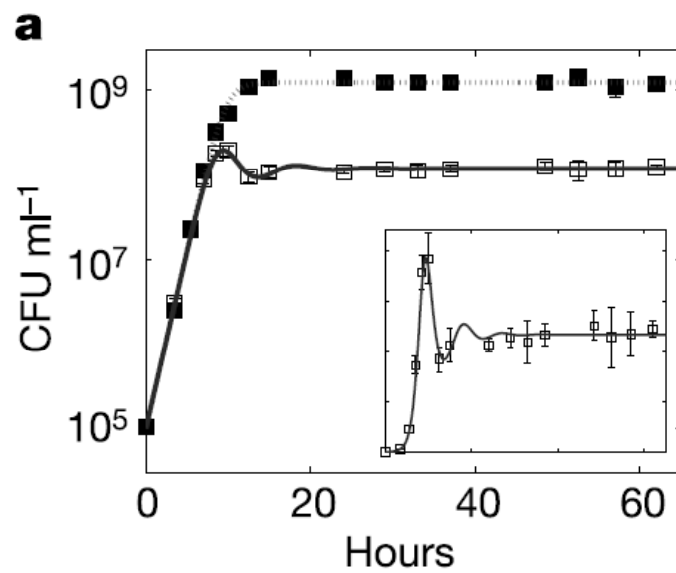
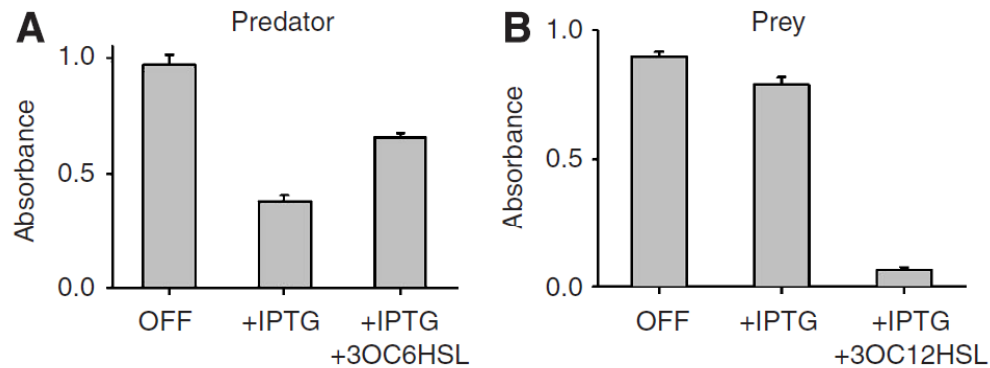
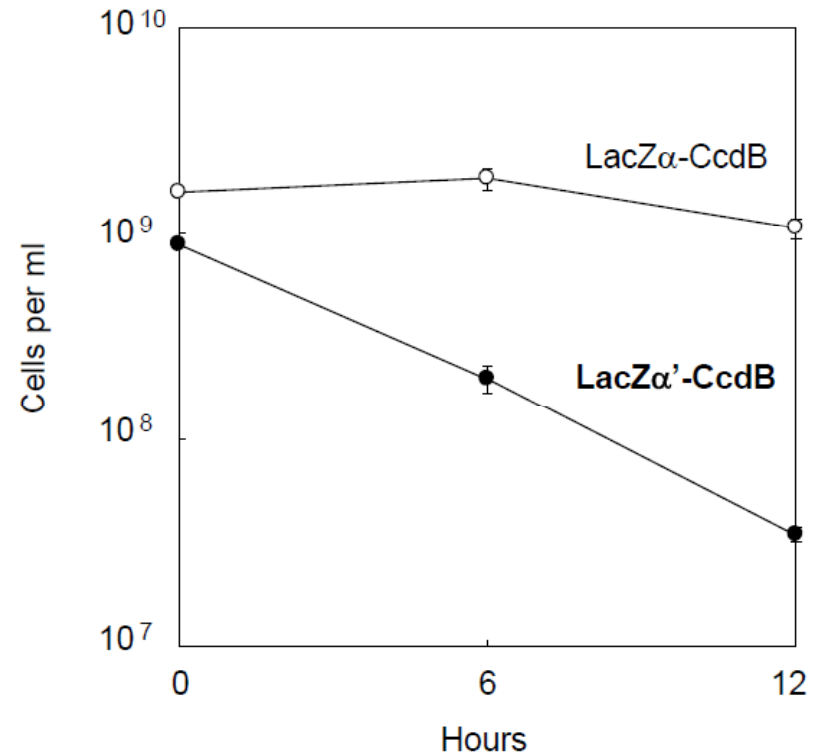

Figure S2:



**Figure 1** Individual growth behaviors (without interactions) of **(A)** predator and **(B)** prey cells in liquid media. For each condition, 6 ml LBK medium containing chloramphenicol and kanamycin was inoculated with a single bacterial colony and was divided into three 2 ml cultures: 'OFF' cultures contained no inducers, '+ IPTG' cultures contained 1 mM IPTG and '+ IPTG + AHL' contained 1 mM IPTG and 100 nM AHL, respectively. After 20h of incubation (light gray bars), optical densities (ODs) of these cultures were measured with a microplate reader (see Supplementary information). Error bars represent standard deviation of triplicate cultures.



# Wiki

- Team project description
- Notebook
  - Meetings
  - Lab Work
  - Sample Naming Sheets
- Logo
- Team
- Other pages



# Calendar of Events

## IGEM 2009 Calendar of Events

[\[edit\]](#)

**Note:** Dates in grey have not been finalized yet. Make sure to check the calendar periodically for any changes!

- 19 February IGEN 2009 registration opens
- 31 March IGEN 2008 registration closes; Team registration fee due
- 13 May DNA Distribution sent to teams (**target deadline; subject to change**)
- 16/17 May [iGEM Workshop, MIT, USA](#)
- 1 June [Visa invitation letter](#) requests due
- 20/21 June [iGEM Workshop, Europe](#)
- 27/28 June [iGEM Workshop, Asia](#)
- 15 June Preliminary team rosters due
- 1 August Team project descriptions due
- 18 September [Jamboree attendance fee due](#)
- TBD [Request for variance](#) due (notice and description of any use of non-standard parts or devices schemes due)
- [Track](#) selection due
- [Project abstracts](#) due
- 18 September [Team rosters](#) due
- TBD Project and part documentation due, including documentation for all medal criteria
- BioBrick Part DNA needs to be received by the Registry
- 30 Oct - 2 Nov iGEM Competition Jamboree, MIT, USA



Thank You