

*E. coli* Automatic Directed  
Evolution Machine (E.ADEM)

v0.0.5.6

2009.9.19

2009.5.3

138 days

2009.9.19

40 days

2009.10.30

## Calendar of Events

### IGEM 2009 Calendar of Events

**Note:** Dates in grey have not been finalized yet. Make sure to check the calendar periodically for any changes!

- 19 February** IGEM 2009 registration opens
- 31 March** IGEM 2008 registration closes; Team registration fee due
- 13 May** DNA Distribution sent to teams (**target deadline; subject to change**)
- 16/17 May** [iGEM Workshop, MIT, USA](#)
- 1 June** [Visa invitation letter requests due](#)
- 20/21 June** [iGEM Workshop, Europe](#)
- 27/28 June** [iGEM Workshop, Asia](#)
- 15 June** Preliminary team rosters due
- 1 August** Team project descriptions due
- 18 September** [Jamboree attendance fee due](#)
- 18 September** [Request for variance](#) due (notice and description of any use of non-standard parts or devices schemes due)
  - [Track selection due](#)
  - [Project abstracts due](#)
  - [Team rosters due](#)
- 21 October** Project and part documentation due, including documentation for all medal criteria
  - BioBrick Part DNA needs to be received by the Registry
  - [Judging form](#) due
  - Wiki FREEZE at 11:59pm, EST
- 30 Oct - 2 Nov** iGEM Competition Jamboree, MIT, USA

**Team Name:**

USTC

**Final Track Selection:**

1. Foundational Advance
2. Information Processing
3. New Application

**Project Name:**

*E. coli* Automatic Directed Evolution Machine: a Universal Framework for Evolutionary Approaches in Synthetic Biology

**Project Abstract:**

Evolution is powerful enough to create everything, from biomolecules to ecosystems. The ultimate goal of *E. coli* Automatic Directed Evolution Machine (E.ADEM) project is to manage the power of evolution, by engineering a robust system framework that can automatically create anything we want in synthetic biology, from various types of parts to complex systems. Each demand can be converted into designing a scoring function to give the evolution process a direction. E.ADEM is designed by implementing evolutionary algorithm back into biology. The core of E.ADEM is a self-adaptive controller that can adjust variation rate and selection pressure, based on fitness score, population size and average fitness score calculated by a quorum sensing device. After comprehensive measurement using constitutive promoter family stimulus signals and modeling of the components, a prototype machine is built. Modular design and PoPS device boundary standard will ensure the extensibility and universality of the machine.

## IGEM 2009 Team Information

Team Name:	<b>USTC</b>
Primary Contact:	Zhaofeng Luo
Schools:	University of Science and Technology of China Hefei, Anhui, P.R. China <a href="http://www.ustc.edu.cn">www.ustc.edu.cn</a>
Description:	University of Science and Technology of China iGEM 2009 wetlab team

### Registration Status

- ✓ Your iGEM 2009 team registration has been accepted by iGEM Headquarters. Welcome to iGEM 2009.
- ✓ DNA Kit of Parts shipping information has been entered, thanks. [View shipping information](#)
- ✓ Resource description has been submitted, thanks. [View resource description](#)
- ✓ Your registration fee has been received. Thank you. [More...](#)

### Team Roster

#### Instructors

<a href="#">smilesun</a>	Zhaofeng Luo	<a href="mailto:lzf@ustc.edu.cn">lzf@ustc.edu.cn</a>
<a href="#">ZhanJian</a>	Zhan Jian	<a href="mailto:zhanjian@ustc.edu">zhanjian@ustc.edu</a>
<a href="#">JiongHong</a>	Jiong Hong	<a href="mailto:hjiong@ustc.edu.cn">hjiong@ustc.edu.cn</a>
<a href="#">XiaoxiaoMa</a>	Xiaoxiao Ma	<a href="mailto:mx0208@mail.ustc.edu.cn">mx0208@mail.ustc.edu.cn</a>

#### Student Members

<a href="#">horigen</a>	Hao Jiang	<a href="mailto:haojiang@mail.ustc.edu.cn">haojiang@mail.ustc.edu.cn</a>
<a href="#">Cherrytree</a>	Jiayi Dou	<a href="mailto:cherrytrees_dot@hotmail.com">cherrytrees_dot@hotmail.com</a>
<a href="#">xingli</a>	Li Xing	<a href="mailto:xingli1@mail.ustc.edu.cn">xingli1@mail.ustc.edu.cn</a>
<a href="#">Horton</a>	Hanyu Lu	<a href="mailto:henrylu@mail.ustc.edu.cn">henrylu@mail.ustc.edu.cn</a>
<a href="#">Emma</a>	Hao Wu	<a href="mailto:wuhao86@mail.ustc.edu.cn">wuhao86@mail.ustc.edu.cn</a>
<a href="#">Ich2009</a>	Chao Li	<a href="mailto:randylch@mail.ustc.edu.cn">randylch@mail.ustc.edu.cn</a>
<a href="#">dianazhou</a>	Hao Zhou	<a href="mailto:dianazh@mail.ustc.edu.cn">dianazh@mail.ustc.edu.cn</a>
<a href="#">dqliu</a>	Danqian Liu	<a href="mailto:dqliu93@mail.ustc.edu.cn">dqliu93@mail.ustc.edu.cn</a>
<a href="#">wub</a>	Bing Wu	<a href="mailto:wub@mail.ustc.edu.cn">wub@mail.ustc.edu.cn</a>
<a href="#">zxhe</a>	Zongxiao He	<a href="mailto:zxhe@mail.ustc.edu.cn">zxhe@mail.ustc.edu.cn</a>

#### Advisors

<a href="#">JiaruiWu</a>	Jiarui Wu	<a href="mailto:wujr@sibs.ac.cn">wujr@sibs.ac.cn</a>
<a href="#">HaiyanLiu</a>	Haiyan Liu	<a href="mailto:hyliu@ustc.edu.cn">hyliu@ustc.edu.cn</a>

This range of part numbers has been assigned to your team for use during the summer: BBa\_K176000 to BBa\_K176999

# iGEM 2009

International Genetically Engineered Machine Competition

## Receipt

Print

Email

Registration ID: 20108107

**Registration Date:** September 18, 2009

**Receipt Date:** September 18, 2009

**Issued By:** MIT Conference Services

**Event:** iGEM 2009 - Jamboree Registration

**Date/Time:** Friday, October 30, 2009 - Monday, November 02, 2009

The following are registered for the event:

Registration ID	Name	Type
<a href="#">20108107</a>	<a href="#">Hao Jiang</a>	Team Member
<a href="#">20108162</a>	<a href="#">Jiayi Dou</a>	Team Member
<a href="#">20108175</a>	<a href="#">Hanyu Lu</a>	Team Member
<a href="#">20108183</a>	<a href="#">Chao Li</a>	Team Member
<a href="#">20108206</a>	<a href="#">Dangqian Liu</a>	Team Member
<a href="#">20108223</a>	<a href="#">Zongxiao He</a>	Team Member
<a href="#">20108245</a>	<a href="#">Bo Ding</a>	Team Member
<a href="#">20108309</a>	<a href="#">Wei Pan</a>	Team Member
<a href="#">20108316</a>	<a href="#">Yuwei Cui</a>	Team Member
<a href="#">20108333</a>	<a href="#">Jiahao Li</a>	Team Member
<a href="#">20108342</a>	<a href="#">Yu He</a>	Team Member

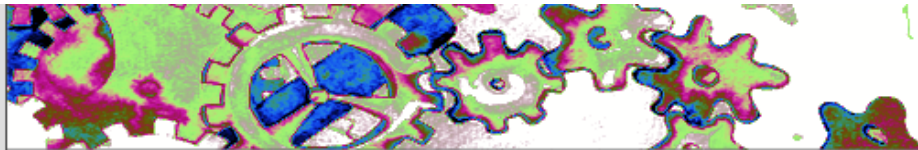

## DNA Submission Instructions

Click [here](#) to access the Online DNA Submission form.

### Contents [\[hide\]](#)

- [1 New DNA Submission](#)
- [2 Sample Information](#)
- [3 Shipment information](#)
- [4 Shipping Instructions](#)
- [5 Notes](#)

## New DNA Submission [\[edit\]](#)

When you come to the DNA Submission main page, you will be able to "start a new DNA submission" or "see your DNA submissions." To begin the submission process click on "start a new DNA submission."

### DNA Submissions

[-> DNA Submissions](#) [-> My Batches](#)



You have designed some new parts, entered them in the Registry and are ready to send the DNA. These pages will help you prepare a batch of parts to send to the registry. They will allow you to track their progress as we receive them and run them through our quality control process.

[Detailed instructions](#)

[Start a New DNA Submission Now](#)

[See Your DNA Submissions Now](#)

On this page that you must enter information about yourself as the user submitting the DNA. Please make sure that the username and full name that we have listed for you is correct. You then need to choose which team you are on (also called a group). Correct your email if necessary and do not forget to enter your phone number.

We have this user name for you: 'meaganl' and this full name: 'Meagan Lizarazo'

Which of your groups is sending the DNA?

We have this email address for you. Please correct it if necessary:

Please enter your phone number:

You must tell us in what format you are sending your DNA. Choose a format from the menu and indicate how many samples you are sending. Click [here](#) for more information about the accepted formats. You should also let us know if there are any special instructions that we must know about.



outbreaks recently, so don't label your DNA E.coli.) Second, plasmid DNA is more stable than stab. Finally, we want to have the parts in our standard strains as part of our input quality control process.

The Plasmid DNA may be sent in:

- Labeled Single PCR Tubes
- 8-Tube Strips
- 96-Well Plates
- Spots on Filter Paper Grids

### Single PCR Tubes



20ng DNA in 10ul TE minimum

Wrap tube in lab tape and label with tube number

Cap tube tightly

Ship in a 50ml Falcon tube labeled with your team name and Order #

Note: The largest problem with single PCR Tubes is trouble reading the label. You can write on the tube in smaller print than we can read reliably. Furthermore, the markings on tubes are often smeared. So, please use a long piece of lab tape all the way around the tube. Fill out the on-line DNA Submission form and write the tube number on the tab of the tape. Use a ball point pen or a permanent marker.

### 8-Tube Strip



20ng DNA in 10ul TE minimum

Wrap first tube in lab tape and label with tube number(e.g. #1, #9, #17, etc)

Cap tightly

Ship 8-tube strips inside a 50ml Falcon tube (two 8-tube strips per tube) labeled with your team name and Order #

### 96-Well Plate

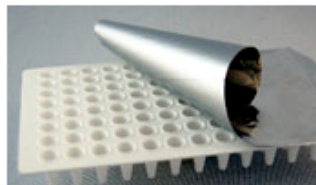

20ng in 10ul TE minimum

Fill in the online DNA Submission form first

Add DNA to the wells in the order 1A, 1B, 1C, ... that is down first then across

Cover tightly with aluminum foil adhesive cover (e.g. Axygen PCR-AS-200)

### Paper Grid



The Registry sent out paper grids that can be used to send dry DNA. Please follow the [instructions on that paper](#).

Fill out the online DNA Submission form first.

Be sure to fill out the form on the paper. Be particularly careful to print the Submission Number from the online form on the paper form.



	1	2	3	4	5	6	7	8	9	10	11	12
A												
B												
C												
D												
E												
F												
G												
H												



Fold #1 Here

Please avoid touching the grid with your hand or arm as you fill out this page.

**Directions**

- Mix 0.4  $\mu\text{L}$  1% Cresol Red with 1.6  $\mu\text{L}$  DNA (your sample should be at a concentration of at least 100 ng/ $\mu\text{L}$ ).
- Place the grid on top of a clean piece of paper. Spot 2  $\mu\text{L}$  in the center of each box. Start at 1A and work your way down each column as you add additional parts.
- Leave spots to dry at room temperature for 1 hour. Make sure the spots are protected from contamination by dust, dirt and aerosols.
- Fill out the form below.
- In order to protect the DNA grid, fold the top third of this page down, the bottom third up, put in an envelope, and mail to Meagan Lizarazo at:  
M.I.T.  
32 Vassar Street, Room 32-314  
Cambridge, MA, 02139  
meaganl@mit.edu  
+1.617.258.5244
- Fill out the online submission form (Instructions at [parts.mit.edu/igem07](http://parts.mit.edu/igem07)).



Fold #2 Here

Please fill in the following fields prior to sending the DNA to the Registry

Submission Number: \_\_\_\_\_

iGEM Team or Lab: \_\_\_\_\_

Prepared By: \_\_\_\_\_ Email: \_\_\_\_\_

Number of Spots: \_\_\_\_\_

Average amount of DNA (ng) per spot: \_\_\_\_\_

Date: \_\_\_\_\_

What format will you be sending?

Single Tubes
  8-Tube Strip
  96-Well Plate
  Paper Grid

Keep in mind that there are specific DNA amount requirements that you must follow.

For single PCR tube:

- 20ng in 10ul volume (2ng/ul) minimum needed
- Wrap tube in lab tape and label with tube number
- Cap tightly and ship in 50ml Falcon tube

For 8-tube strips:

- 20ng in 10ul volume (2ng/ul) minimum needed
- Cap tightly
- Wrap 1st tube on each 8-tube strip with lab tape and write the correct tube number (e.g. # 1, 9, 17 etc.) with a permanent marker on the tape
- Ship 8-tube strips inside a 50ml Falcon tube (2 8-tube strips per 50ml Falcon tube)

For 96-well plate:

- 20ng in 10ul volume (2ng/ul) minimum needed
- Add DNA to wells in the order of down row 1, down row 2, etc. (i.e. #1 = 1A, #2 = 1B, #3 = 1C, #4 = 1D, #5 = 1E, #6 = 1F, #7 = 1G, #8 = 1H, #9 = 2A, #10 = 2B, etc.)
- Cover tightly and carefully with aluminum foil adhesive cover (e.g. Axygen PCR-AS-200).

For filter paper grid:

- Spot at least 160ng DNA onto middle of each square, going down each row in order from left to right (follow the instructions printed on the grid).
- Fill out the online submission form as well as the paper submission form (with the grid and instructions on how to send the DNA in using this format)
- Remember to carefully fold the filter paper grid according to the instructions provided on the filter paper.

Proceed to entering sample information by clicking on the button at the bottom of the page.

[Proceed to create the new DNA submission and enter sample information](#)

## Sample Information

[\[edit\]](#)

At the top of the sample information page you will see your Shipment #. You will need to remember this number, in particular if you are sending your DNA in filter paper grid format. In this case the shipment # needs to be written clearly on the filter paper grid form.

<b>Shipment: 00029</b> User: Meagan Lizarazo For Group: iGEM_Registry	Format:  Paper Grid 1 Samples
---	--

Samples:

1 Samples

Samples:

Loc	Part	Plasmid	Resistance	Notes
1A	<input type="text"/>	<input type="text"/>	<input type="text"/>	<input type="checkbox"/> Toxic to Top-10 Cells <input type="checkbox"/> Sending plasmid not part <input type="checkbox"/> No part or plasmid (explain in comments) <input type="checkbox"/> Sequenced
Comments: <input type="text"/>				<a href="#">Cancel</a> <a href="#">Save</a>

Begin to enter the information for your first part, beginning with the part number. You must enter the plasmid that the part is in. Note that the software will only recognize plasmids that are documented in the Registry so if you haven't added your plasmid to the Registry you must do so before submitting your parts. See the "Notes" section below for more details on plasmid information.

Once you have entered the part number and plasmid for your part, you can tab over to the antibiotic resistance field. The software will automatically fill in the antibiotic resistance based on the plasmid that you have entered. Please check to make sure that the resistance is correct. You may change it manually if it is not correct. The antibiotic abbreviation is the first letter of the antibiotic.

Please check any of the boxes that apply to your part if:

1. It is toxic to Top10 cells,
2. You are only sending a plasmid,
3. It is not a part or plasmid
4. Your team has sequenced this part

We need to know specifically whether your part is toxic to Top10 cell strain because it is our standard strain. We will be transforming all parts into Top10 and we need to know in advance whether this will be a problem with any of your parts. If you are sending us a plasmid, you need to check the appropriate box (see below for more plasmid information).

Please let us know by checking the box if you or your team has sequenced this part. This is **not** a box to have your part sequenced. At the moment we will not be collecting any sequence data or trace files but at some point in the future we will enable this feature. Please save all of your sequencing data in the event that you would like to add that information at a later date.

At this point you may add any notes that you may want to communicate with the Registry regarding your part in the comments field.

Tube	Part	Plasmid	Resistance	Notes
1	<input type="text"/>	<input type="text"/>	<input type="text"/>	<input type="checkbox"/> Toxic to Top-10 Cells <input type="checkbox"/> Sending plasmid not part <input type="checkbox"/> No part or plasmid (explain in comments) <input type="checkbox"/> Sequenced
Comments: <input type="text"/>				<a href="#">Cancel</a> <a href="#">Save</a>

→

Once you have finished adding all of the information for your part, **click on the "save" link** and then "add another sample" button and proceed to filling out all the information as above for each part that you are sending to the Registry. The information for each sample is automatically saved to this shipment number once you click on the "save" link.

## Shipment information

[\[edit\]](#)

When you are done filling in the information for all of your samples, click on the "I am finished specifying the samples" button.

Be aware that your shipment has not yet been finalized (even though it has been saved). To do so, you must fill in all of your shipping information. Please provide ALL information.

in all of your shipping information. Please provide ALL information.

Shipping details	
Date Sent:	<input type="text" value="yyyy-mm-dd"/>
Tracking #:	<input type="text" value="None provided"/>
Carrier:	<input type="text" value=""/>
Comments:	<input type="text" value=""/>

If you need to obtain a tracking number for your package before finalizing your shipment, you may do so at anytime and come back to finalize your shipment once you have a tracking number. You must provide the shipping details before your information gets sent to the Registry so make sure to come back and complete the shipping details portion of the form.

When you are finished providing shipping details, click on the "I am finished filling in this information" button to send your information to the Registry.

I am finished filling in the information, Send this batch to the Registry

This finalizes your shipment information. You will see a confirmation page that congratulates you on submitting your information. It will also show all parts that are part of that shipment number. We recommend printing out this page for your records.

At this point you can go back to the DNA Submission Registry page and click on "see your DNA submissions" to check on the status of your shipment. You will be able to see when we have received your shipment and once we have finished testing your parts, you will be able to see the results from our quality control tests.

If for any reason we reject your part we will notify you by email (see below for possible reasons your part might be rejected). The email will be sent to the user who filled out the online submission form. The rest of the parts in your shipment that passed the quality control tests will be marked as Accepted but you will have to resubmit the parts that did not pass successfully. These parts must be resubmitted as a new shipment using the online DNA submission form once again.

Reasons for failing quality control:

- Failed to transform
- Did not grow in culture
- Growth in wrong antibiotic broth in antibiotic test
- Wrong fragment size when cut with double restriction enzymes

## Shipping Instructions

[\[edit\]](#)

Please send your samples via a shipping company that will let you track the shipment. It is important to include your shipment tracking number in your submission information details. Physical DNA for parts is due before the Jamboree (see the [iGEM requirements](#)) and if we do not receive your shipment, we will track your package and give that information to the judges. If your shipment does not have tracking information and has not arrived at the Registry we will count your physical DNA as **not available**. You will not be able to receive a medal, as per the [iGEM requirements](#).

**\*Important\***: When shipping your samples, make sure to include a detailed description of the package so that it gets through customs. Write the following:

**Dry/liquid DNA, non-hazardous, non-infectious, non-regulated. For research use only.**

# Assembly

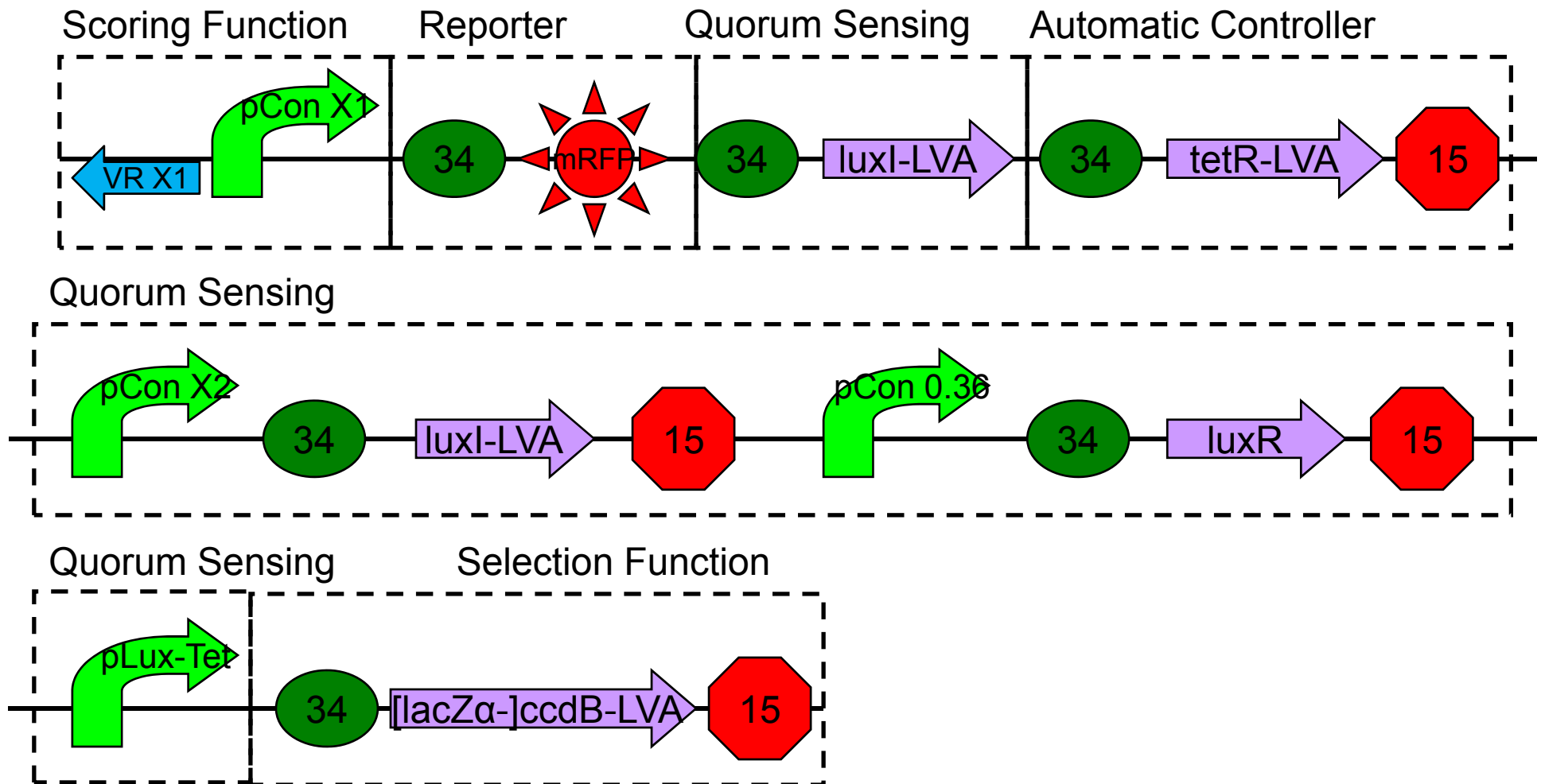

1. pLux-Tet
2. pLux-Tet + GFP
3. pCon  $\times$  4 + luxR + pLux-Tet
4. ccdB  $\times$  8
5. pCon  $\times$  8
6. pCon  $\times$  8 + GFP
7. pCon + luxR
8. pCon  $\times$  7 + luxI (AHL detection by 9)
9. pCon + luxR  $\times$  4 + pLux-Tet + GFP (AHL)
10. pCon + luxR  $\times$  4 + pLux-Tet + ccdB  $\times$  8 (AHL)
11. tetR  $\times$  2
12. tetR  $\times$  2 + pCon  $\times$  2 + luxR + pLux-Tet [+ GFP]
13. pCon  $\times$  4 + tetR  $\times$  2 + pCon  $\times$  2 + luxR + pLux-Tet [+ GFP] (AHL/aTc)
14. [pCon  $\times$  7 +] luxI + pCon  $\times$  2 + luxR + pLux-Tet [+ ccdB  $\times$  8 | + GFP]
15. VR  $\times$  10
16. (VR + pCon)  $\times$  7
17. tetR + pCon + luxI + pCon + luxR + pLux-Tet [+ ccdB]
18. [mRFP +] luxI + tetR + pCon + luxI + pCon + luxR + pLux-Tet [+ ccdB]
19. (VR + pCon)  $\times$  6 + tetR + pCon + luxI + pCon + luxR + pLux-Tet [+ ccdB]
20. (VR + pCon)  $\times$  6 + mRFP + luxI + tetR + pCon + luxI + pCon + luxR + pLux-Tet [+ ccdB]

Delayed  
Waiting  
Working  
Done  
Sequenced

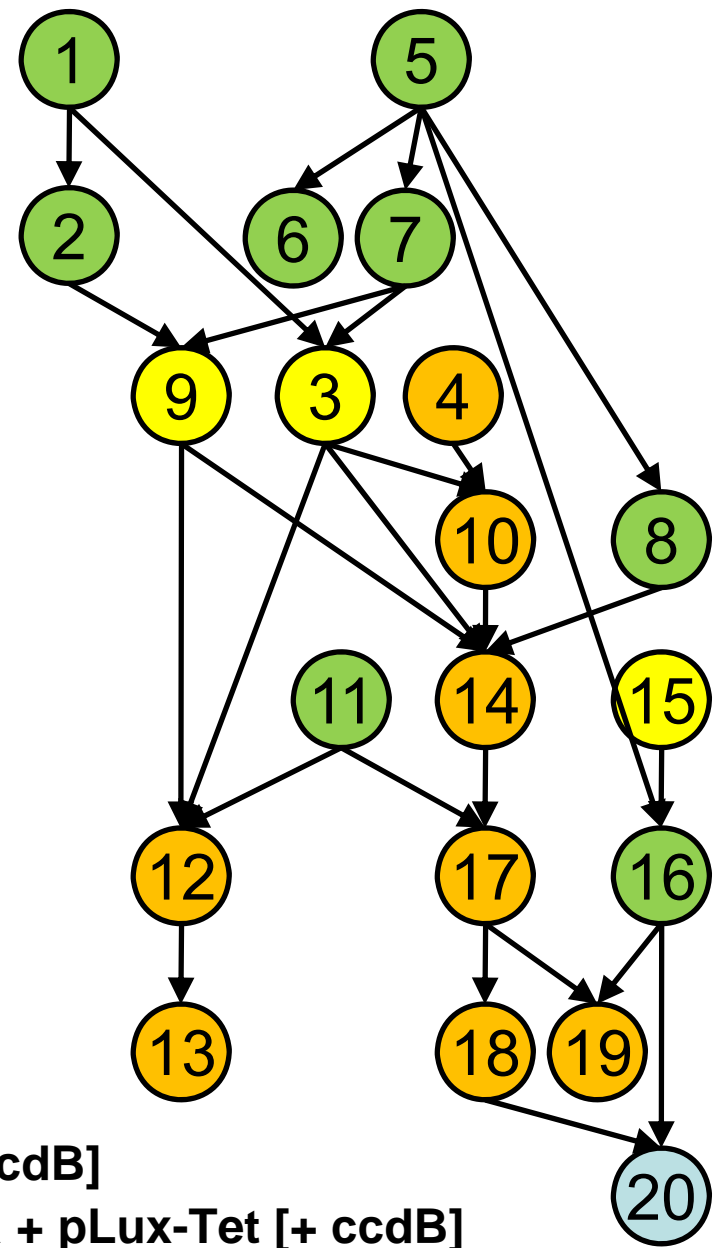

### Evolution Object

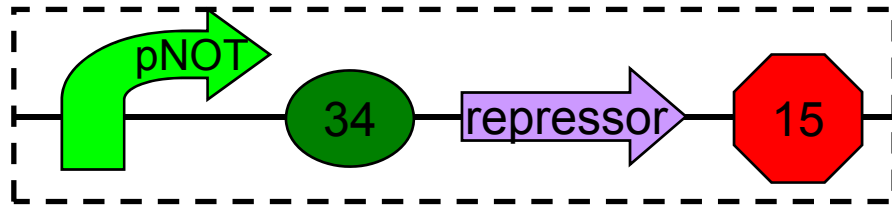

### Scoring Function

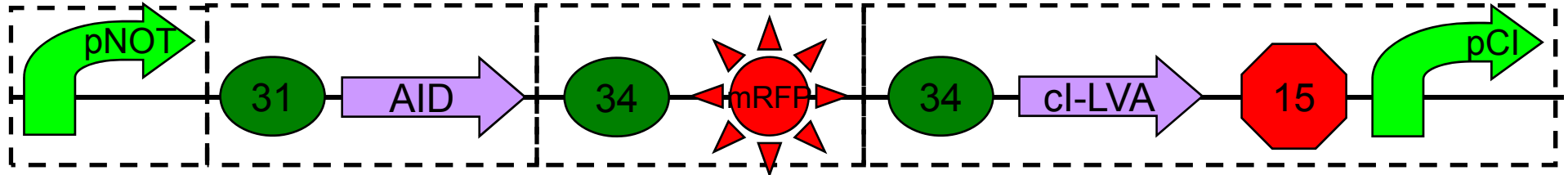

### Quorum Sensing

### Automatic Controller

### Quorum Sensing

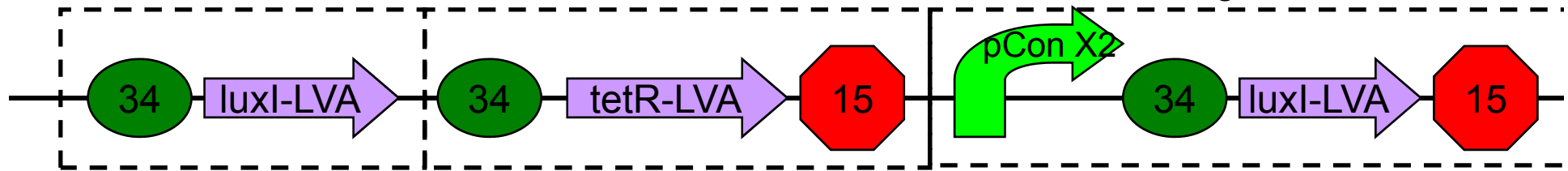

### Quorum Sensing

### Selection Function

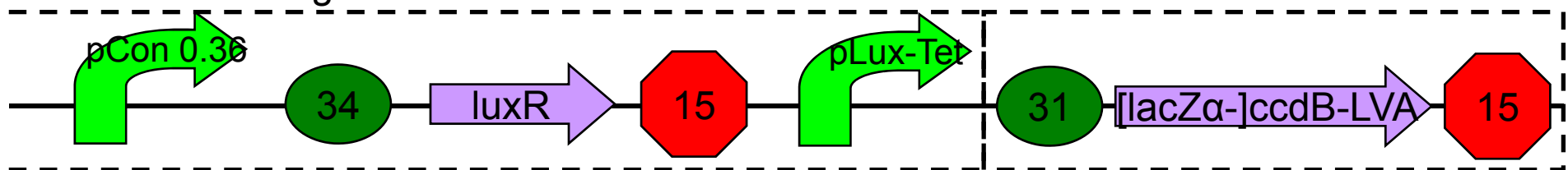

- 21. cl + pCl
- 22. cl + pCl + GFP
- 23. (VR + pCon) × 7 + cl + pCl + GFP
- 24. cl + pCl + luxI
- 25. AID
- 26. [AID +] mRFP + cl + pCl + luxI
- 27. [AID +] mRFP + cl + pCl + luxI + tetR + pCon + luxI + pCon + luxR + pLux-Tet [+ ccdB]
- 28. (VR + pCon) × 7 + mRFP + cl + pCl + luxI + tetR + pCon + luxI + pCon + luxR + pLux-Tet [+ ccdB]
- 29. pNOT
- 30. pNOT + GFP
- 31. pNOT + [AID +] mRFP + cl + pCl + luxI
- 32. pNOT + [AID +] mRFP + cl + pCl + luxI + tetR + pCon + luxI + pCon + luxR + pLux-Tet [+ ccdB]
- 33. repressor
- 34. pNOT + repressor

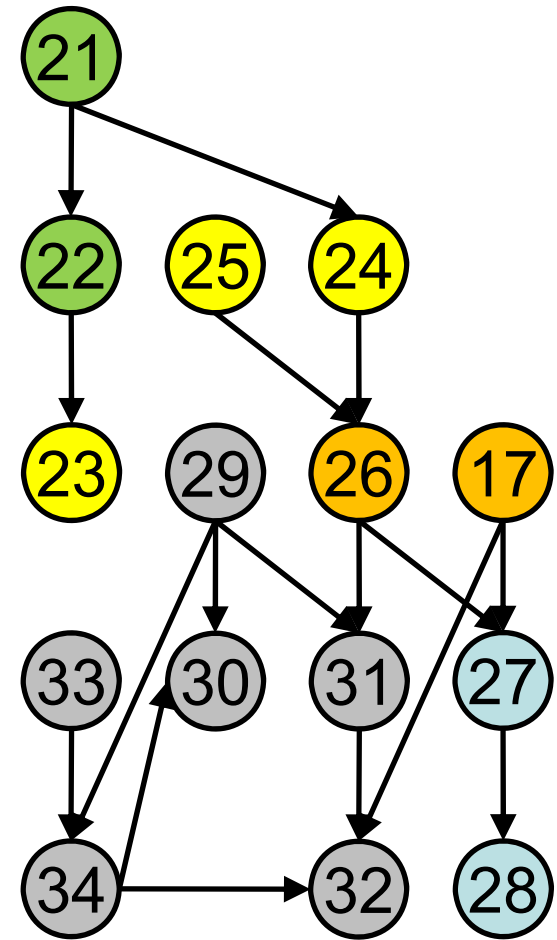



1

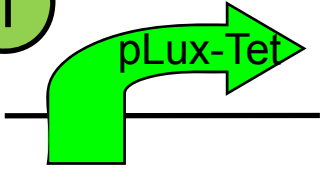

K176000 X+P with nicks  
Sequence OK



G00100  
Synthesis OK



G00101  
Synthesis OK

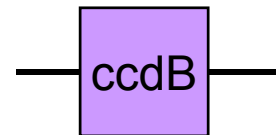

P1010 in pSB1A3 in DB 3.1  
Length OK



pSB1A3 X+P  
Length OK

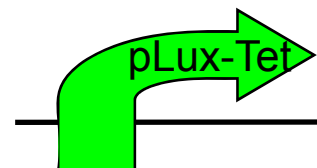

K176000 in pSB1A3  
Sequence OK

2

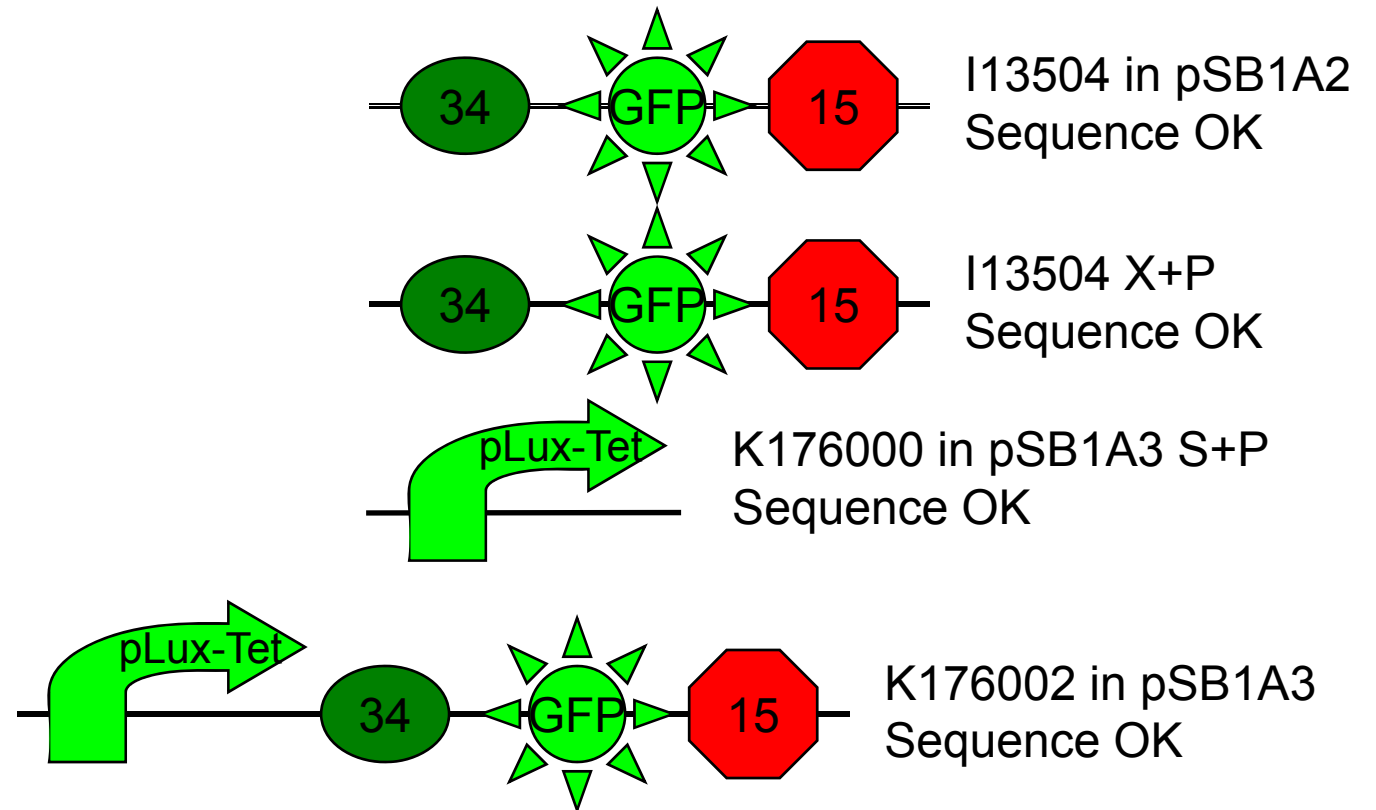

4



K145151 in pSB1A2 in DB3.1

Sequence OK

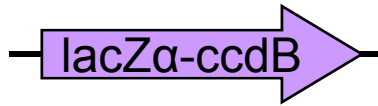

K176003 fragment  
Length OK



B0034 in pSB1A2  
Sequence OK



B0034 in pSB1A2 S+P  
Length OK

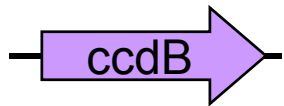

K145151 X+P  
Length OK

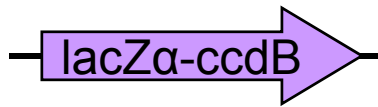

K176003 X+P  
Length OK

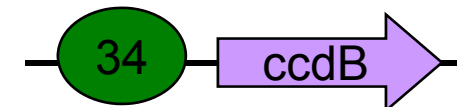

K176010 in pSB1A2 in DB3.1  
Ligation

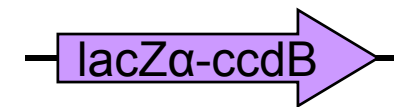

K176003 in pSB1A3 in DB3.1  
Sequence OK

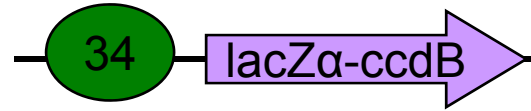

K176027 in pSB1A2 in DB3.1  
Sequence OK

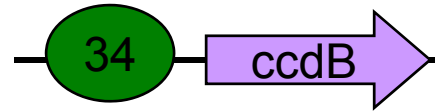

K176010 E+S  
Length OK

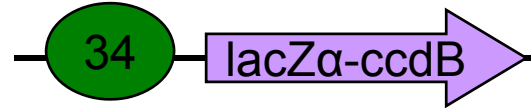

K176027 E+S  
Length OK

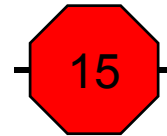

B0015 in pSB1AK3  
Sequence OK



B0031 in pSB1A2  
Length OK



B0031 S+P  
Length OK

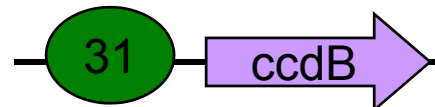

K176060 in pSB1A2 in DB3.1  
Sequence OK

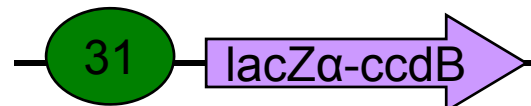

K176061 in pSB1A2 in DB3.1  
Sequence OK

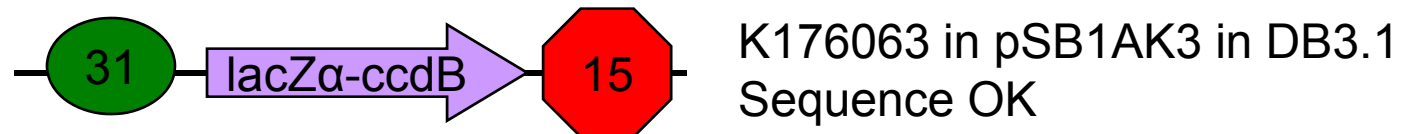
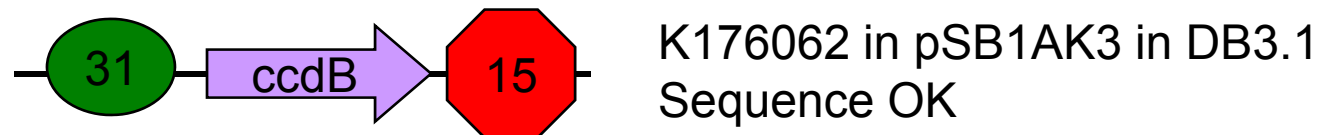
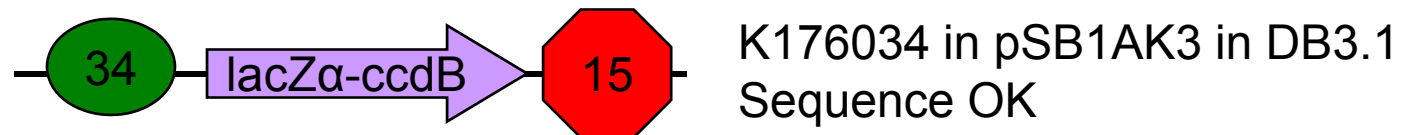
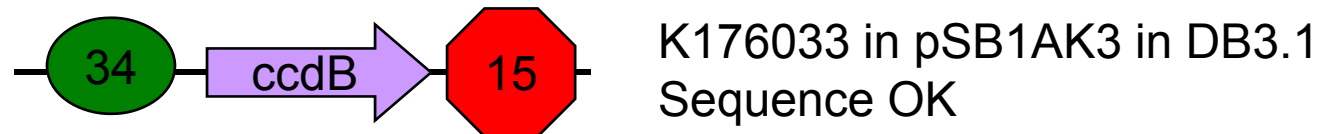
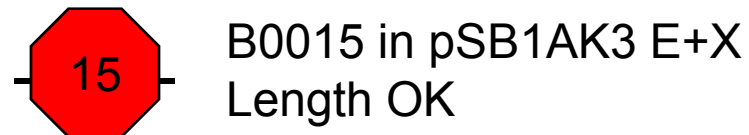
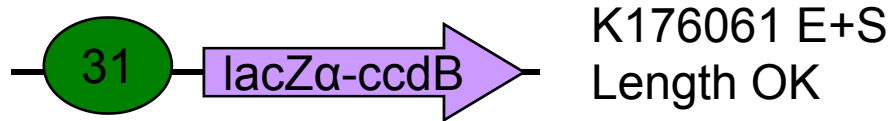
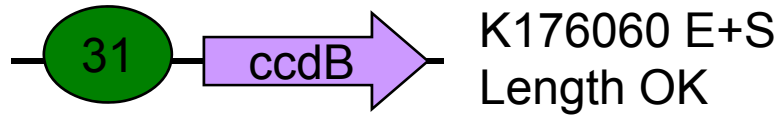

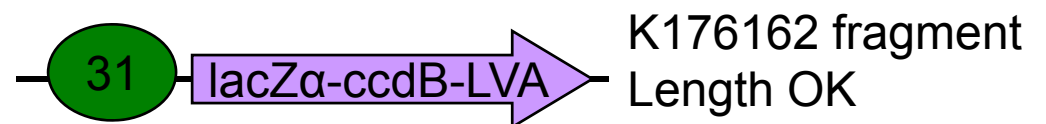
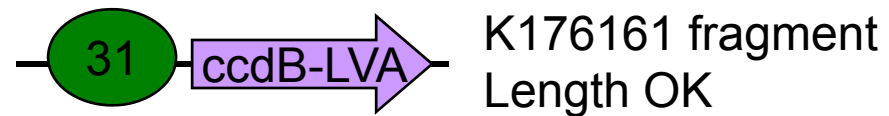
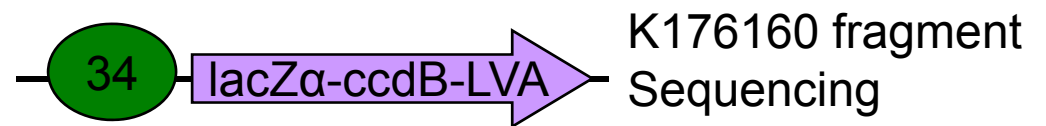
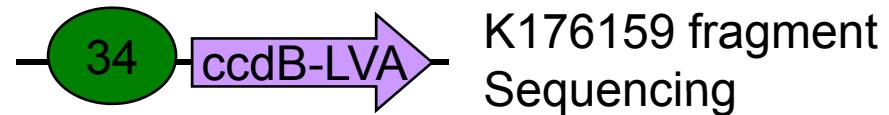
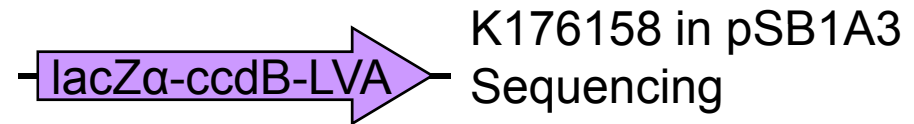
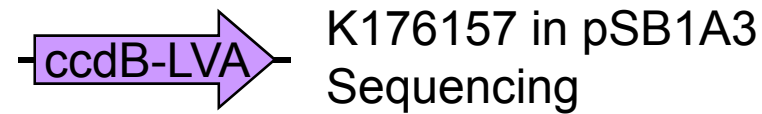
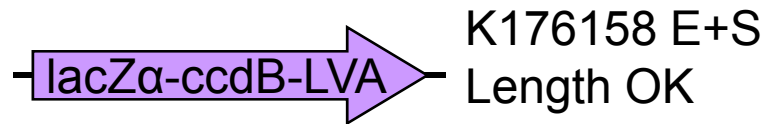
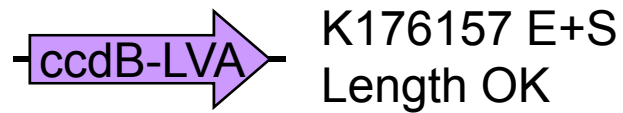
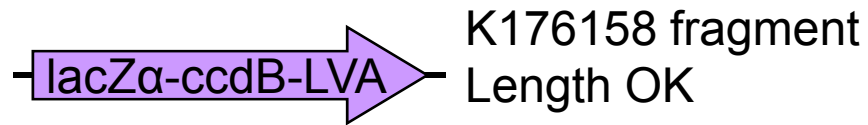

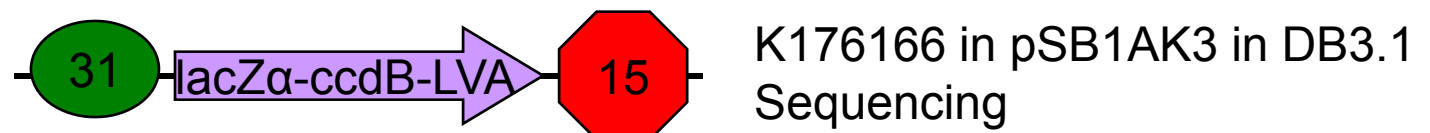
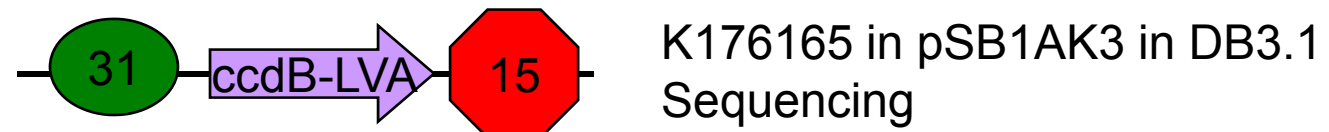
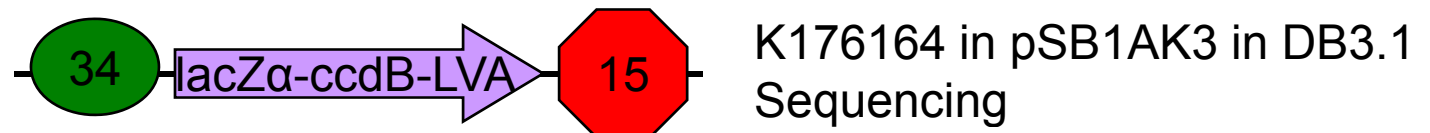
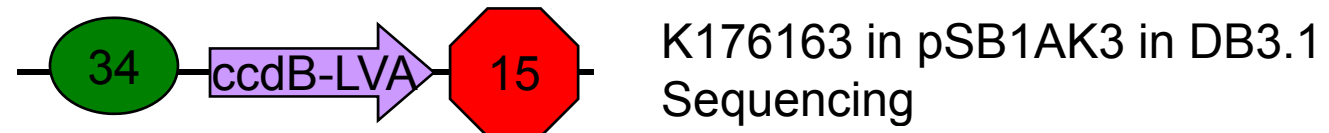
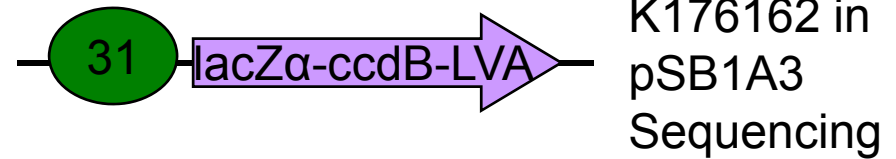
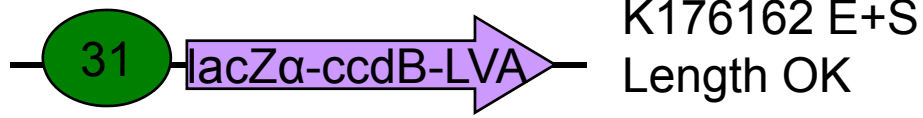
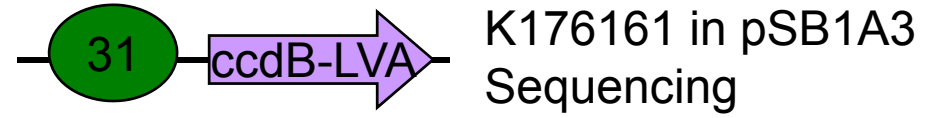
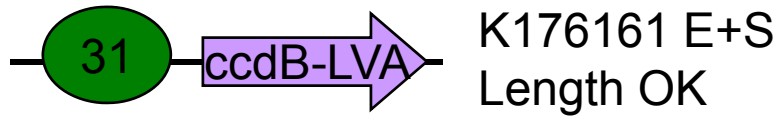
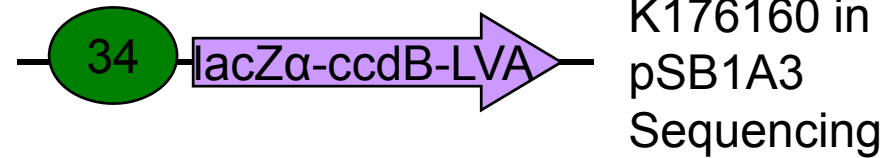
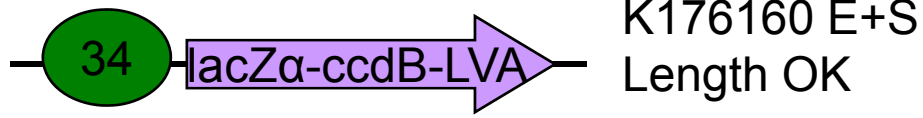
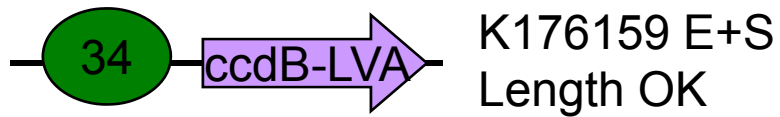

5

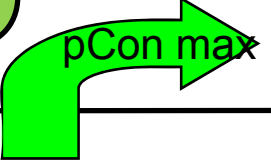
 pCon max J23119 in pSB1A2  
Sequence OK

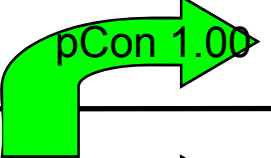
 pCon 1.00 J23100 in J61002  
Sequence ?

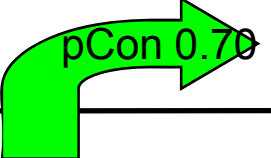
 pCon 0.70 J23101 in J61002  
Sequence OK

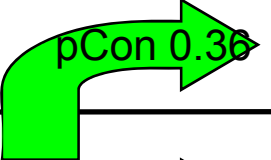
 pCon 0.36 K176009 in J61002  
Sequence OK

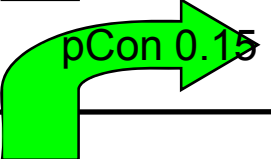
 pCon 0.15 K176008 in J61002  
Sequence OK

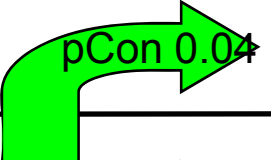
 pCon 0.04 J23109 in J61002  
Sequence OK

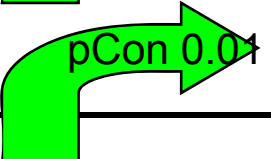
 pCon 0.04 J23103 in J61002  
Sequence OK

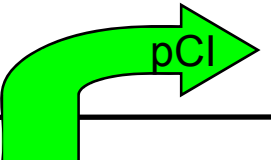
 pCl R0051 in pSB1A2  
Sequence OK

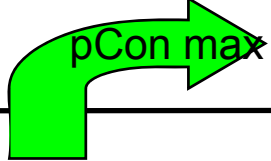
 pCon max J23119 X+P  
Sequence OK

 pCon 1.00 J23100-J61002SF X+P  
Sequence ?

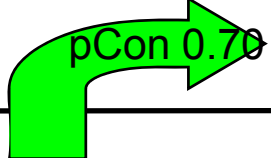
 pCon 0.70 J23101-J61002SF X+P  
Sequence OK

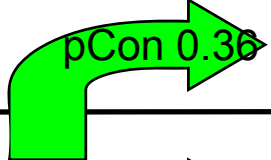
 pCon 0.36 K176009-J61002SF X+P  
Sequence OK

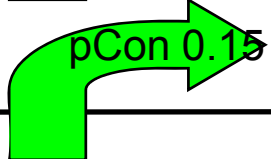
 pCon 0.15 K176008-J61002SF X+P  
Sequence OK

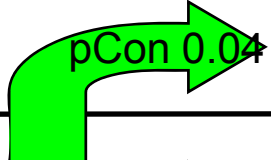
 pCon 0.04 J23109-J61002SF X+P  
Sequence OK

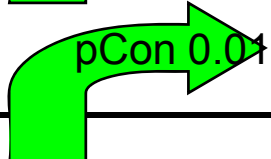
 pCon 0.04 J23103-J61002SF X+P  
Sequence OK

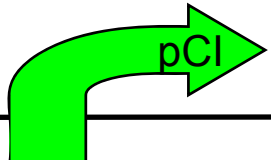
 pCl R0051 X+P  
Length OK

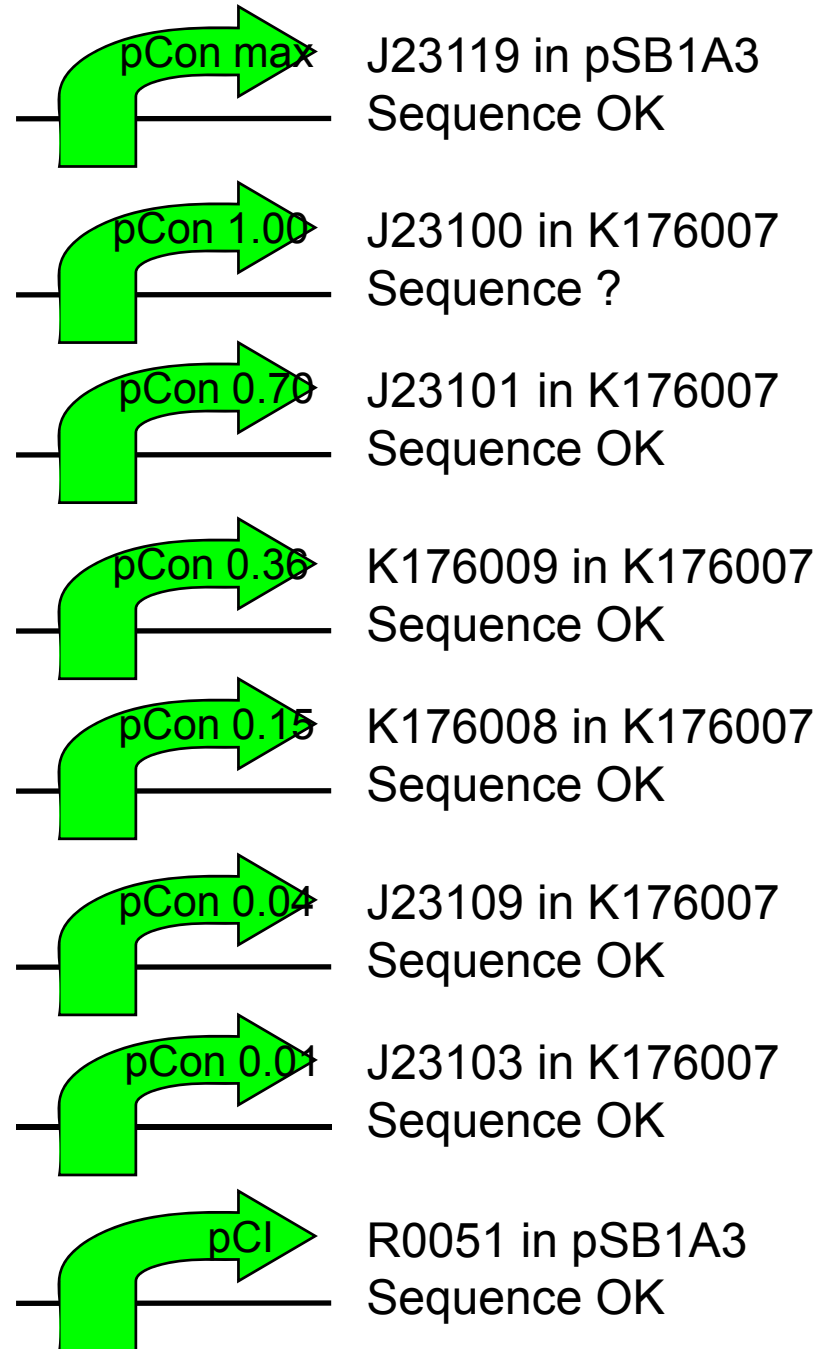



6

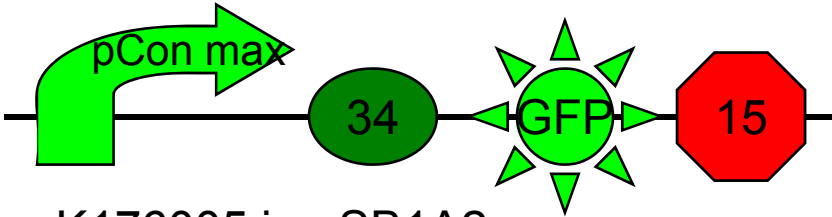
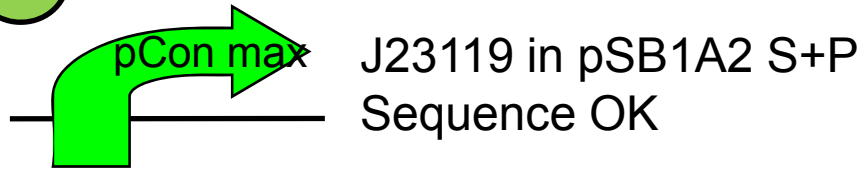

K176005 in pSB1A2  
Sequence OK

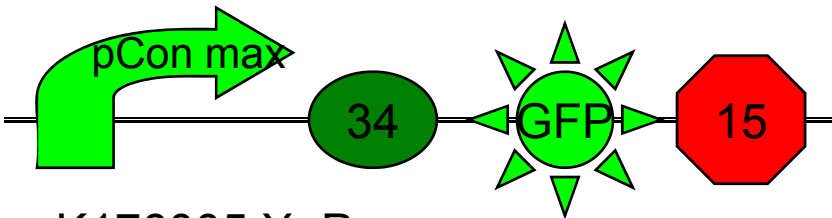

K176005 X+P  
Length OK

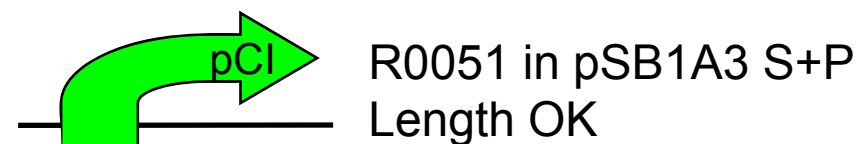
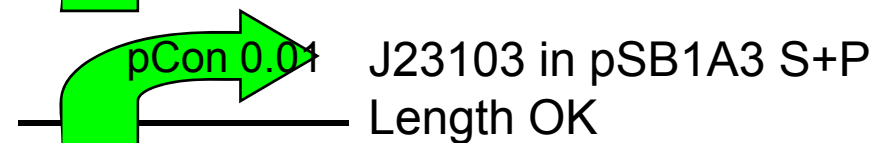
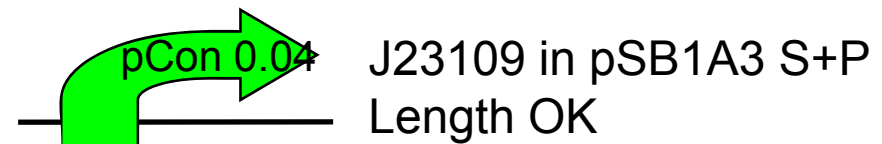
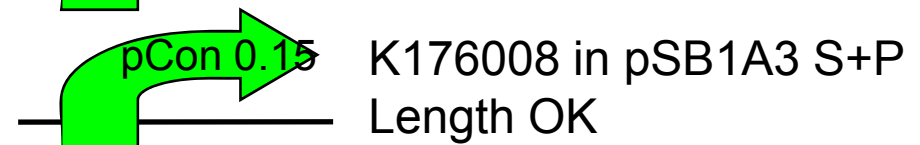
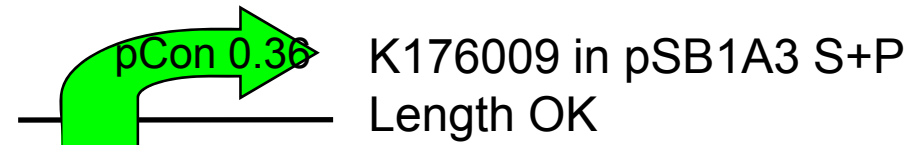
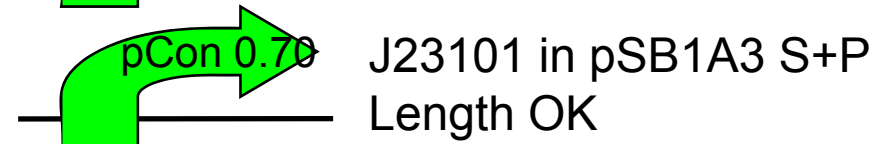
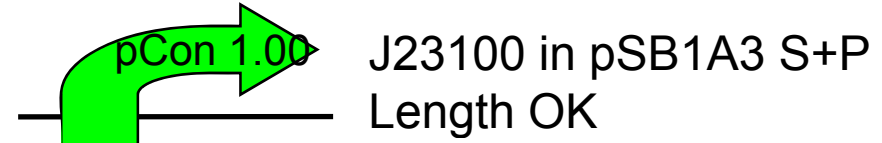
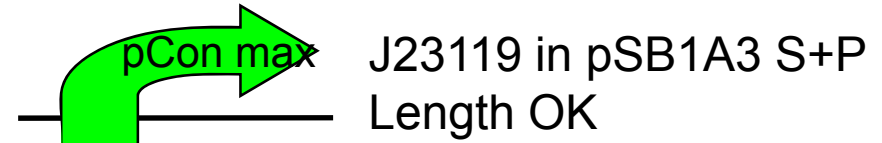

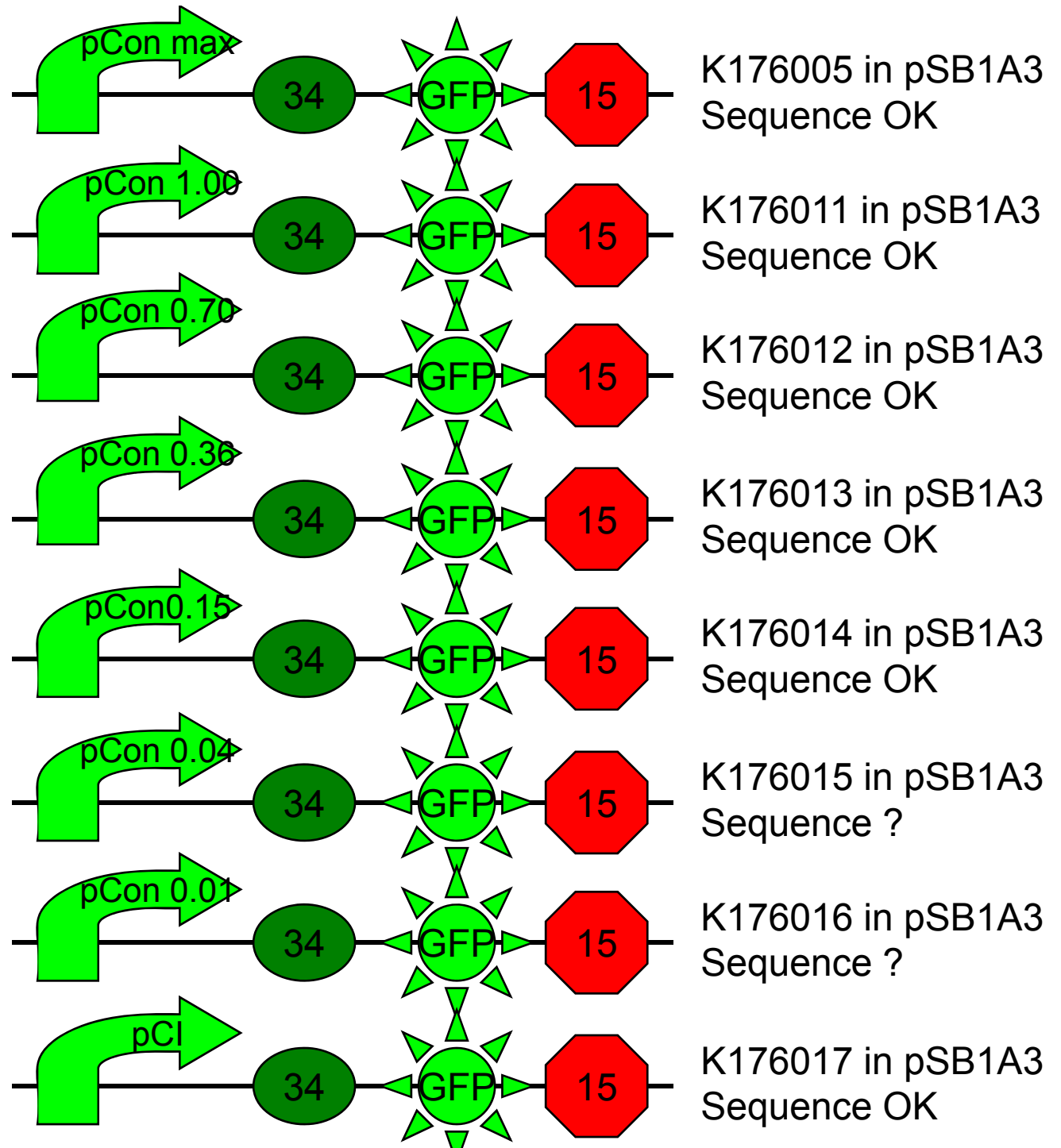

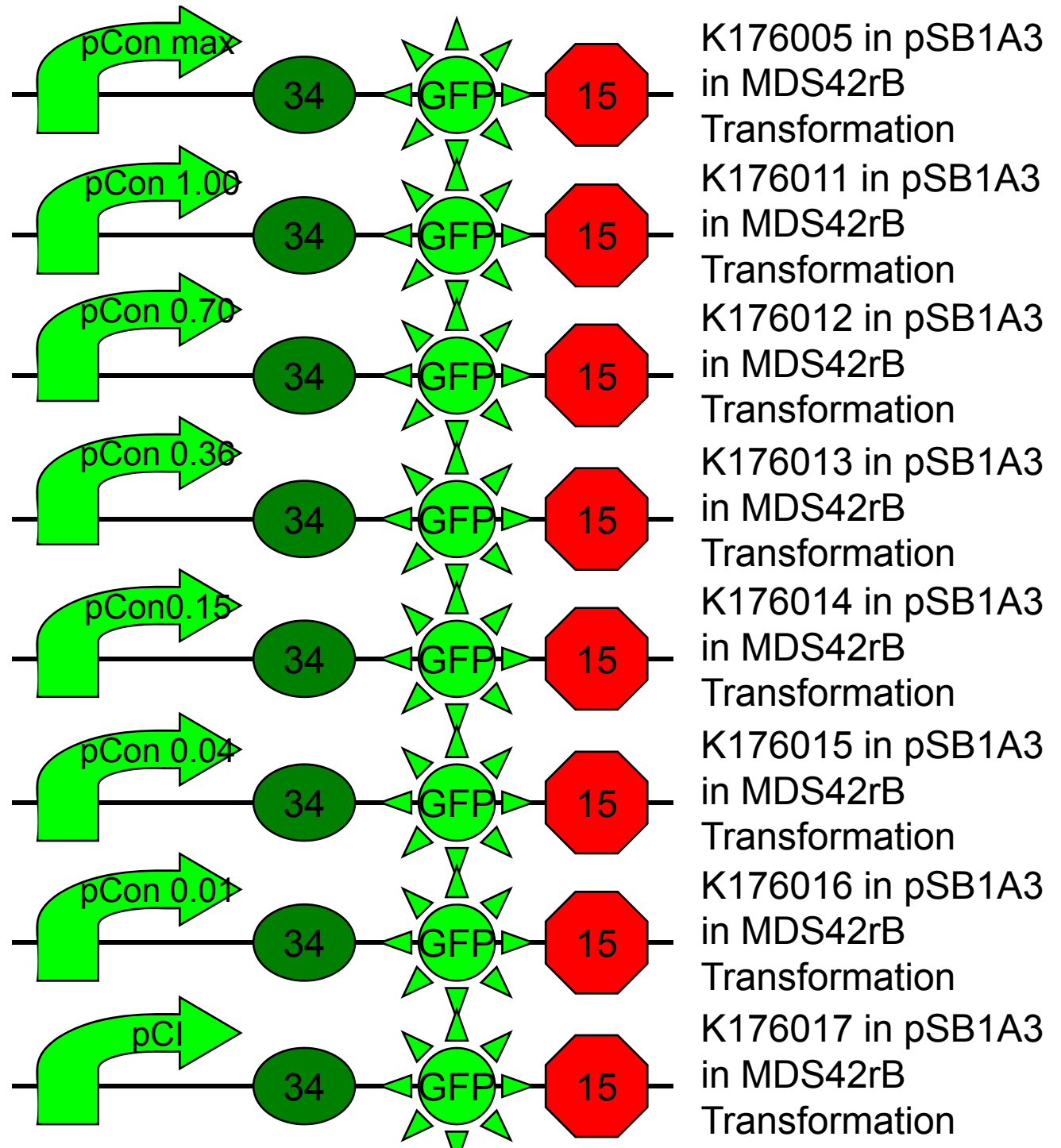

# Flu:OD

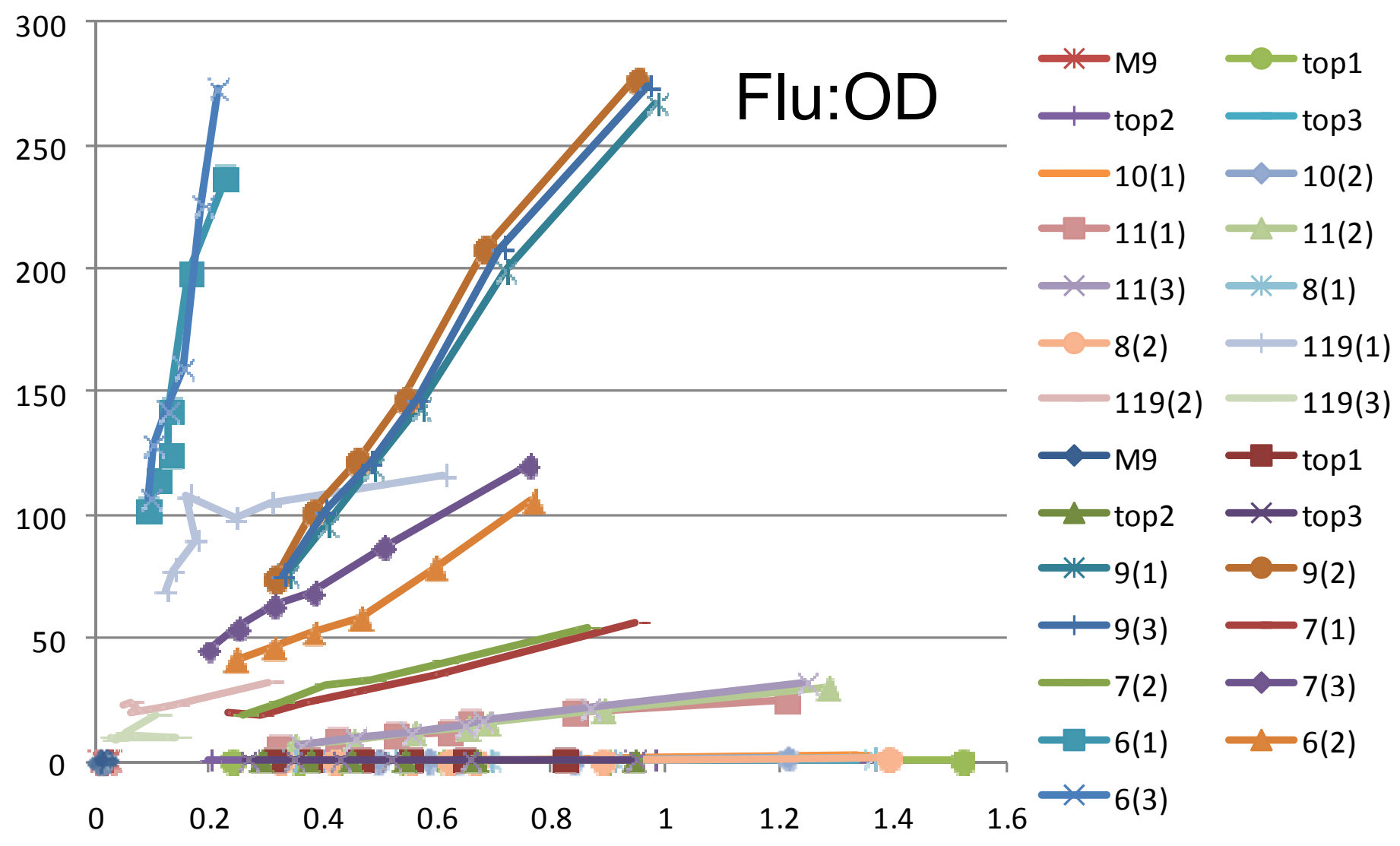





# MDS42 recA Blue

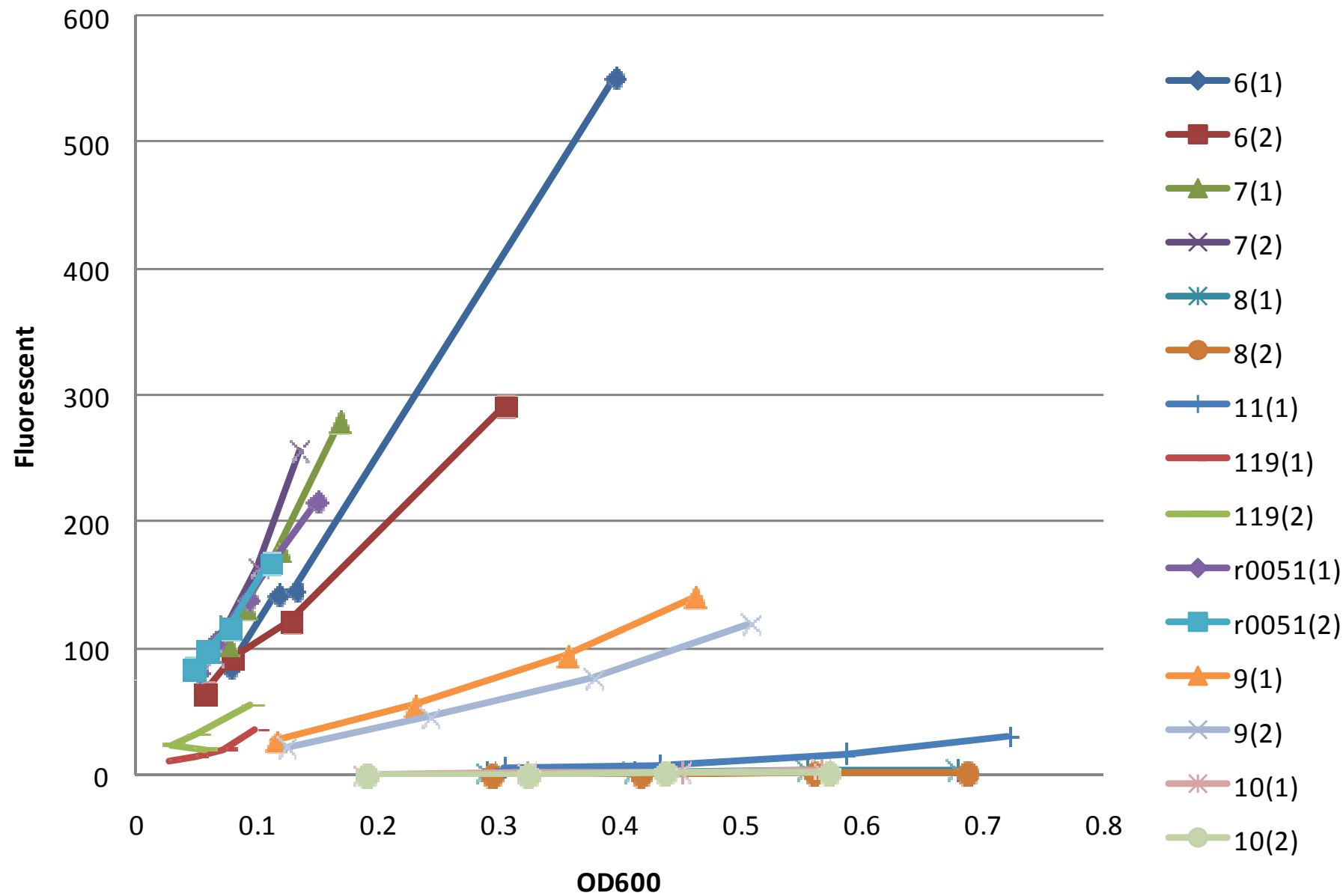

7

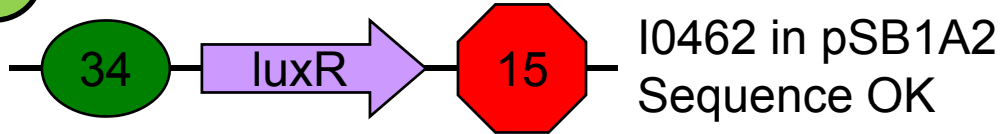

I0462 in pSB1A2  
Sequence OK

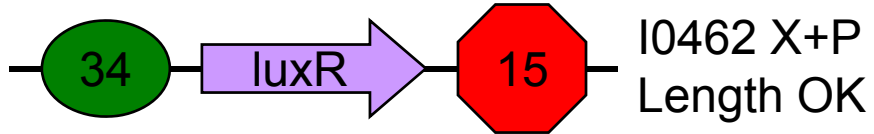

I0462 X+P  
Length OK

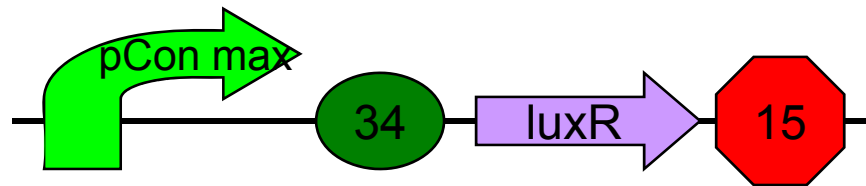

K176004 in pSB1A2  
Sequence OK  
Length ?

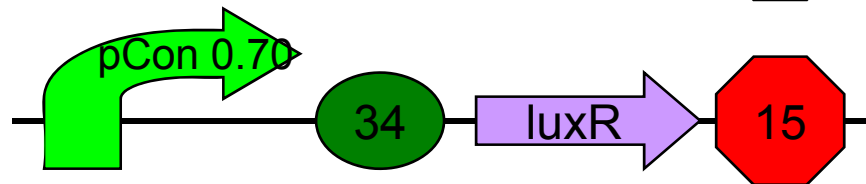

K176025 in pSB1A3  
Sequence ?



8

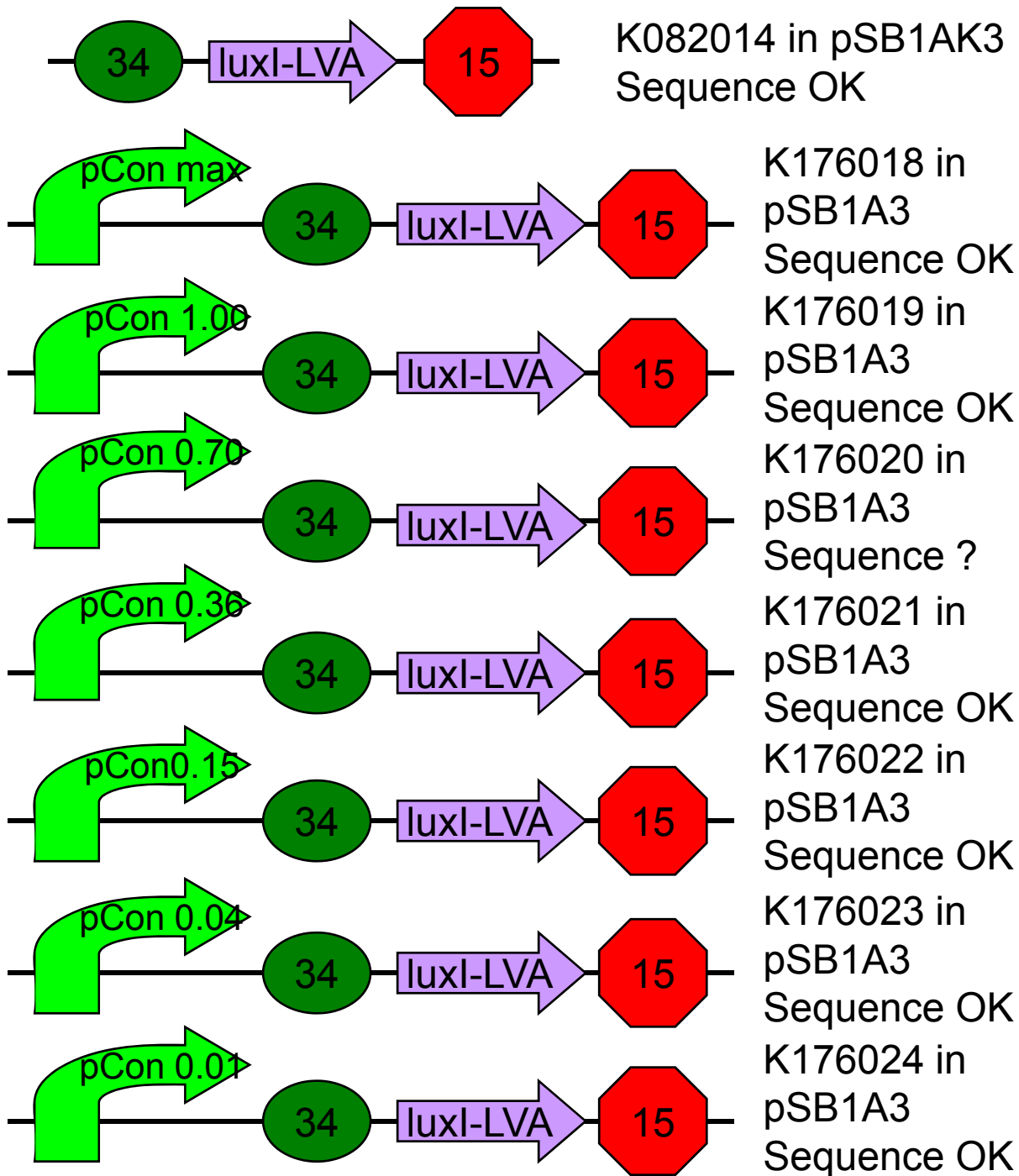

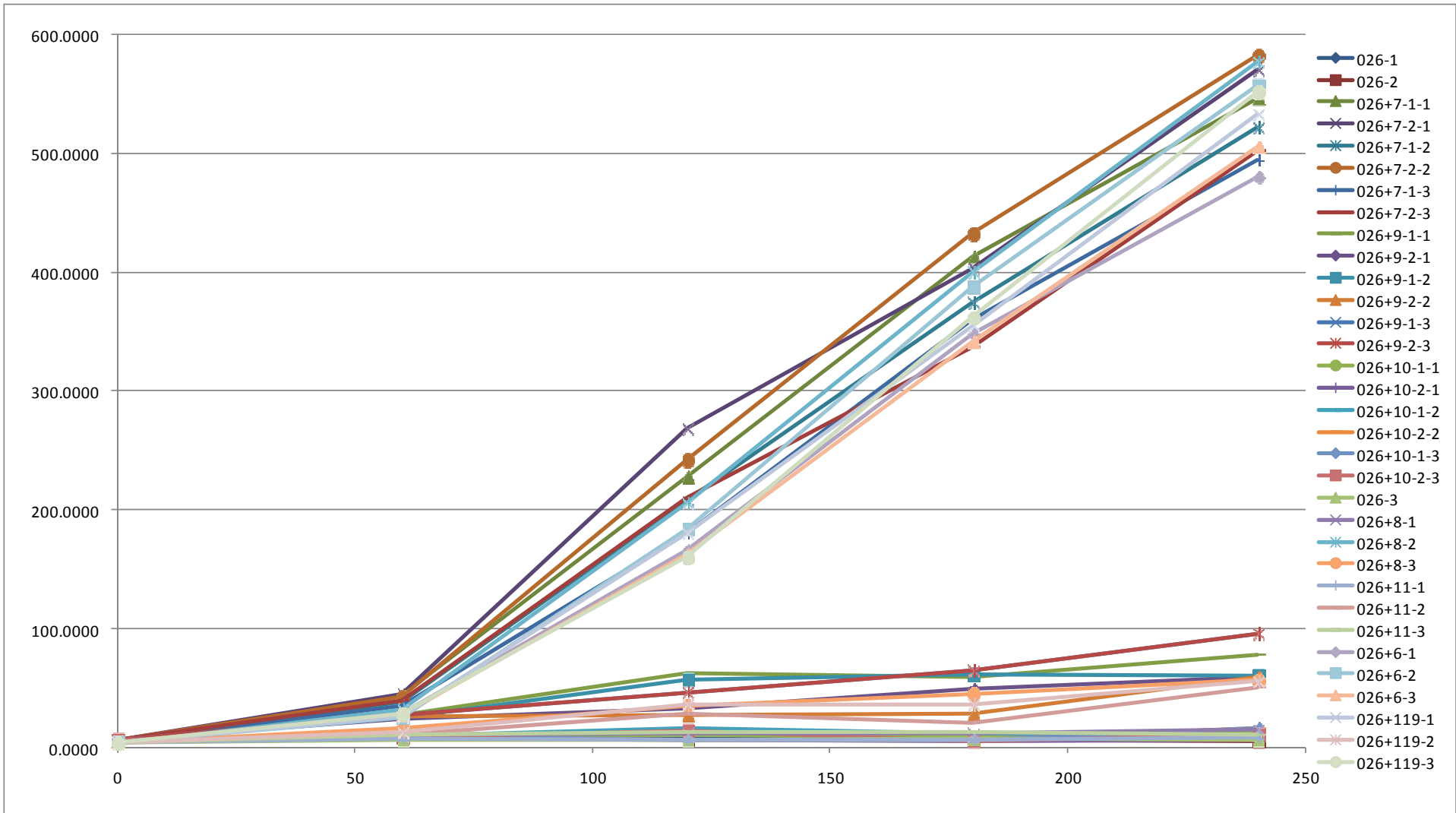

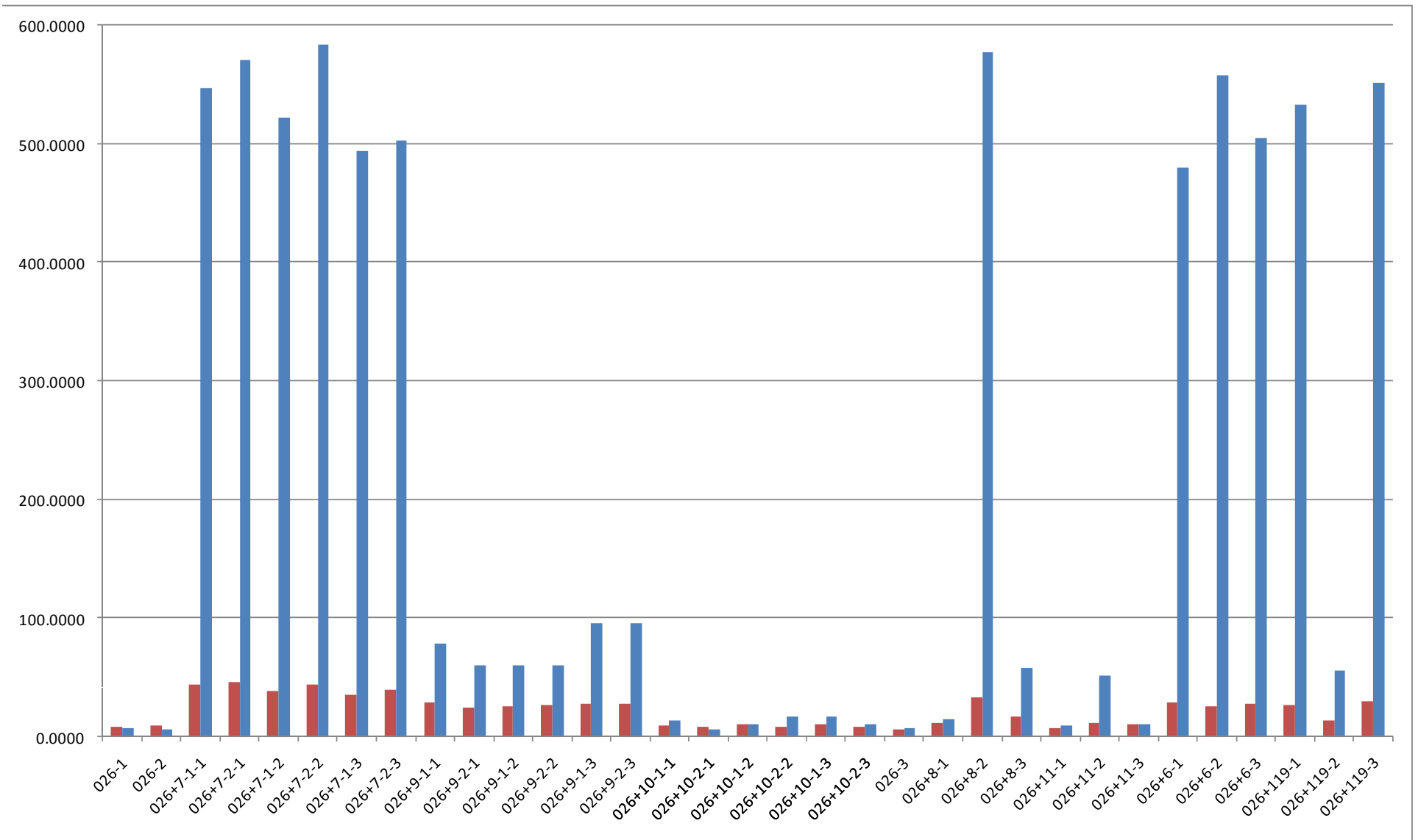

# 10+R+002 (K176003)

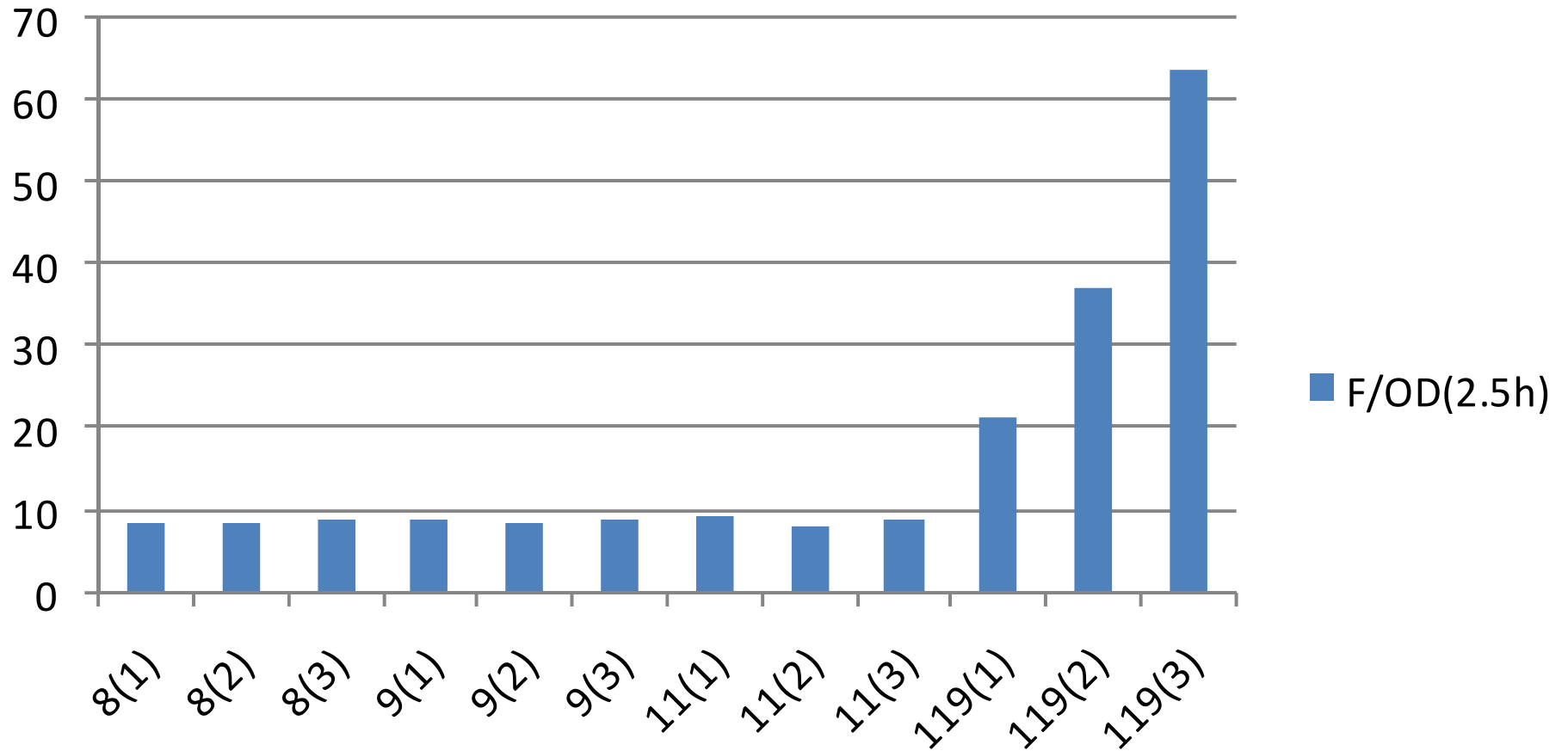

3

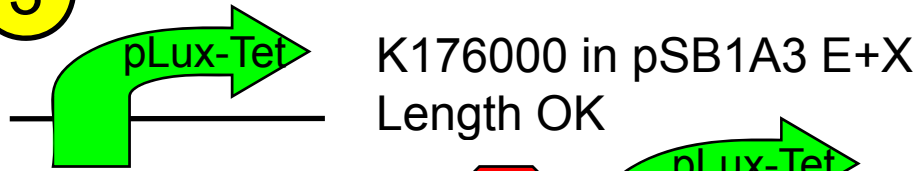

K176000 in pSB1A3 E+X  
Length OK

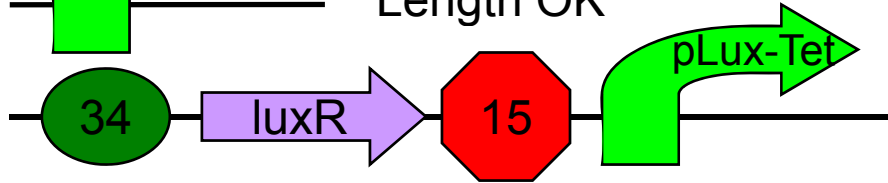

K176123 in pSB1A3  
Sequencing

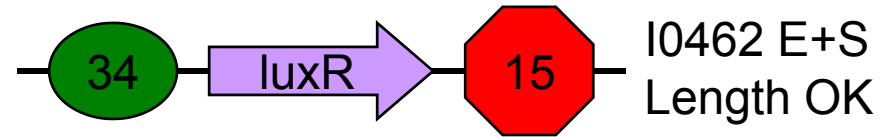

I0462 E+S  
Length OK

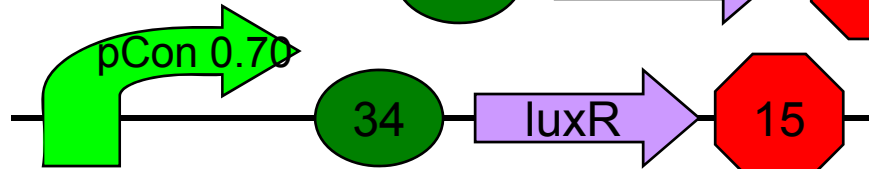

K176025 E+S  
Length OK

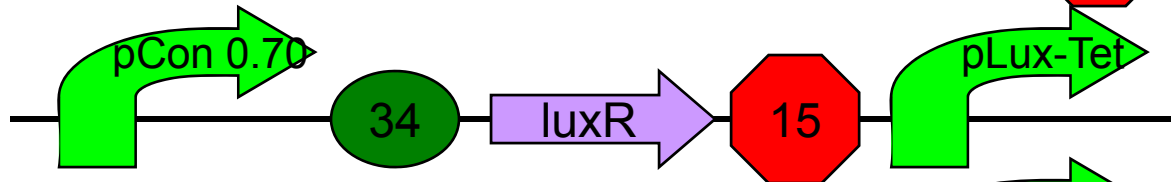

K176028 in pSB1A3  
Sequence ?

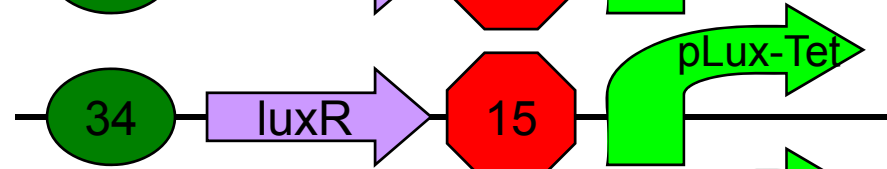

K176123 X+P  
Length OK

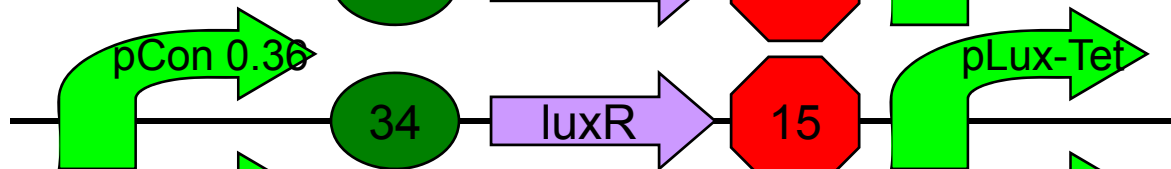

K176125 in pSB1A3  
Sequencing

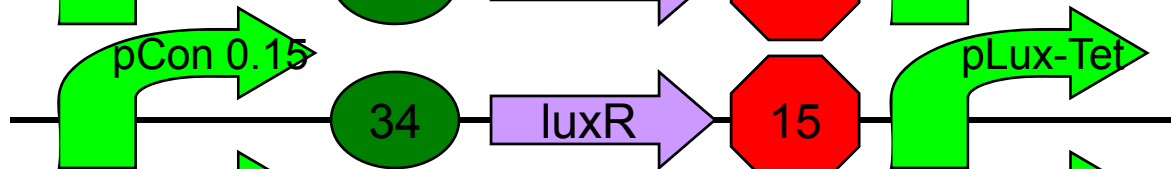

K176127 in pSB1A3  
Sequencing

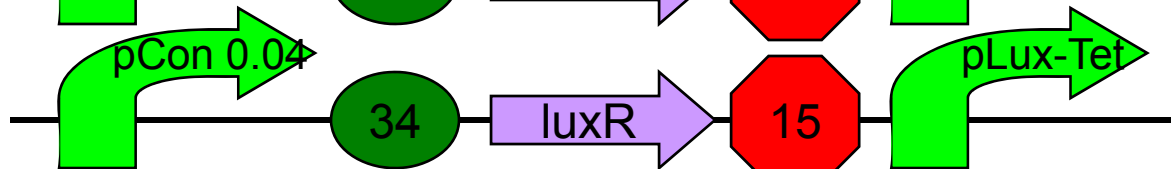

K176129 in pSB1A3  
Sequencing

9

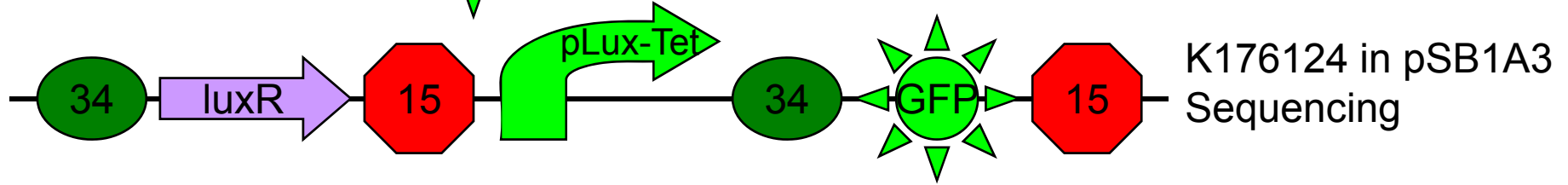
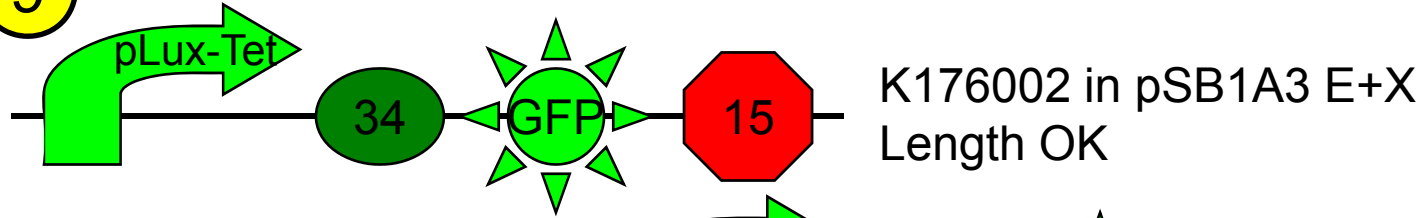

VRGFP ←  
G00201  
Synthesis OK

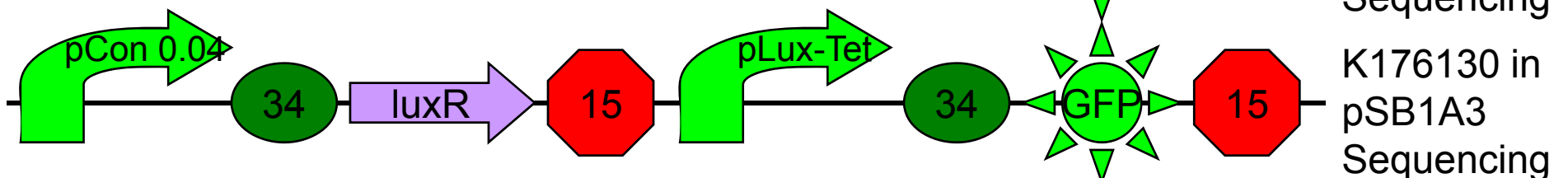
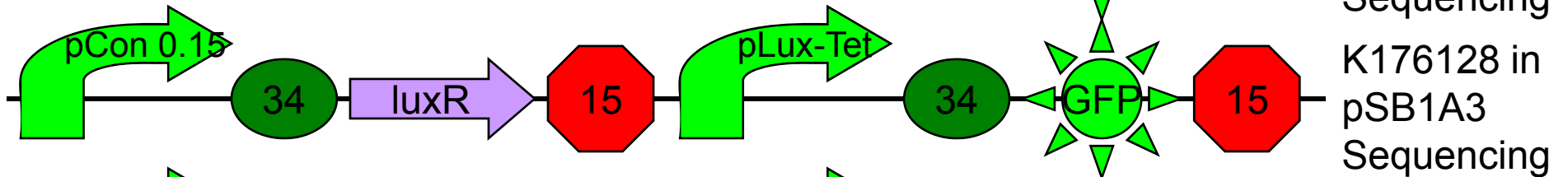
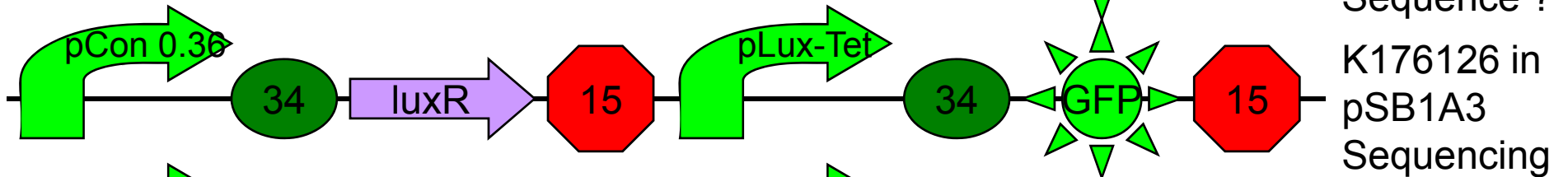
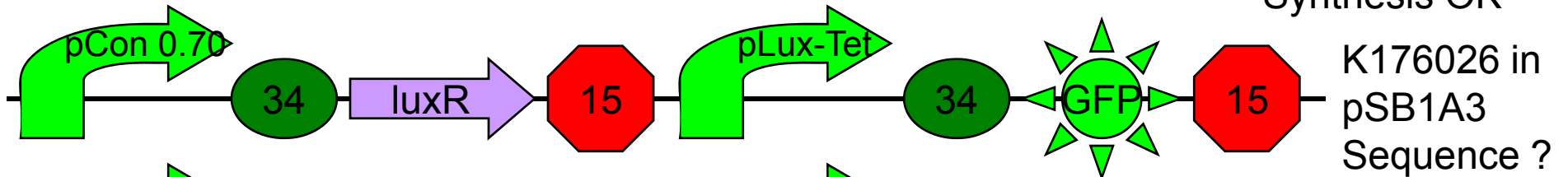

# Methods

- Plate Reader
- Spectrophotometer

Flu:t(min)

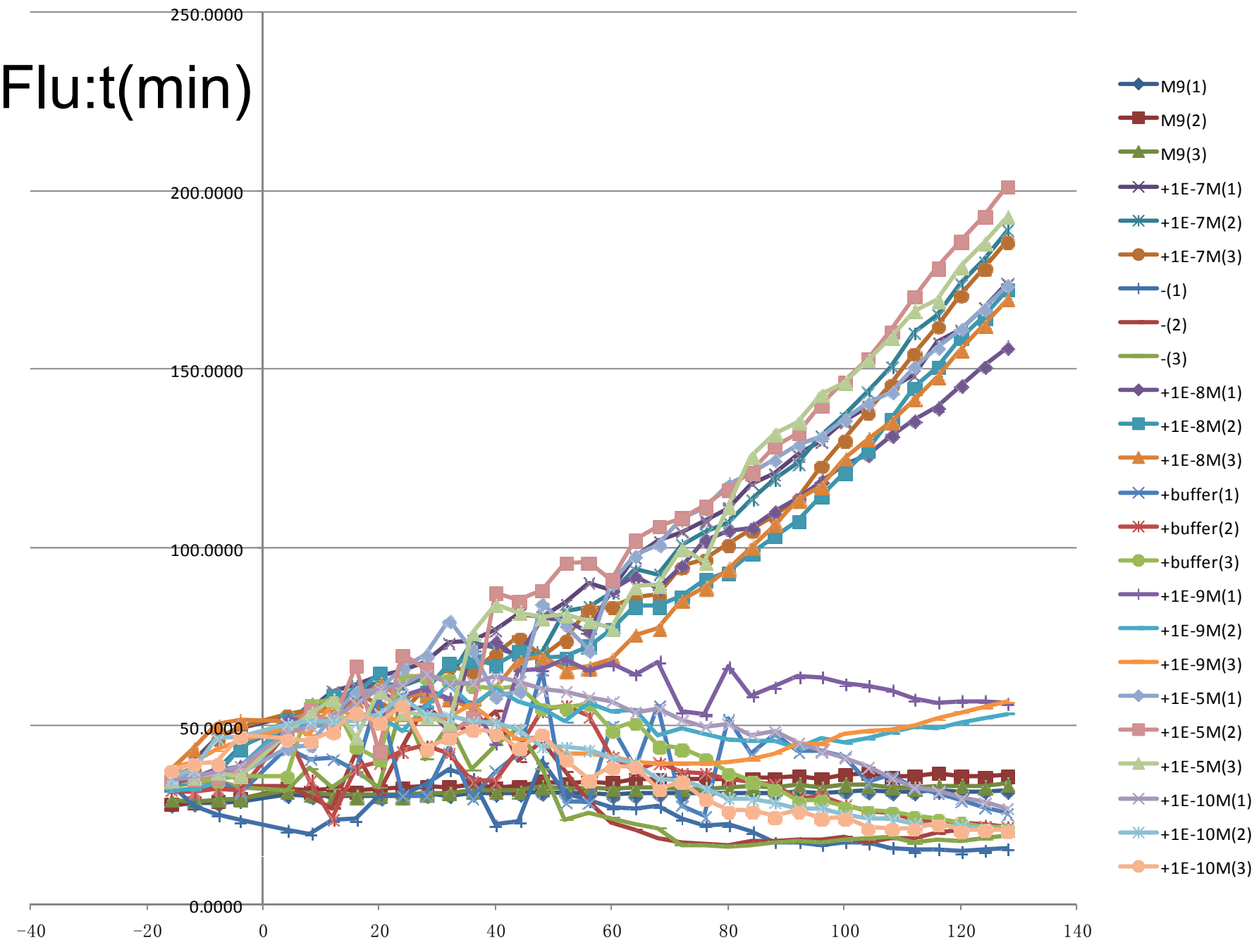



# Flu/OD:t(min)

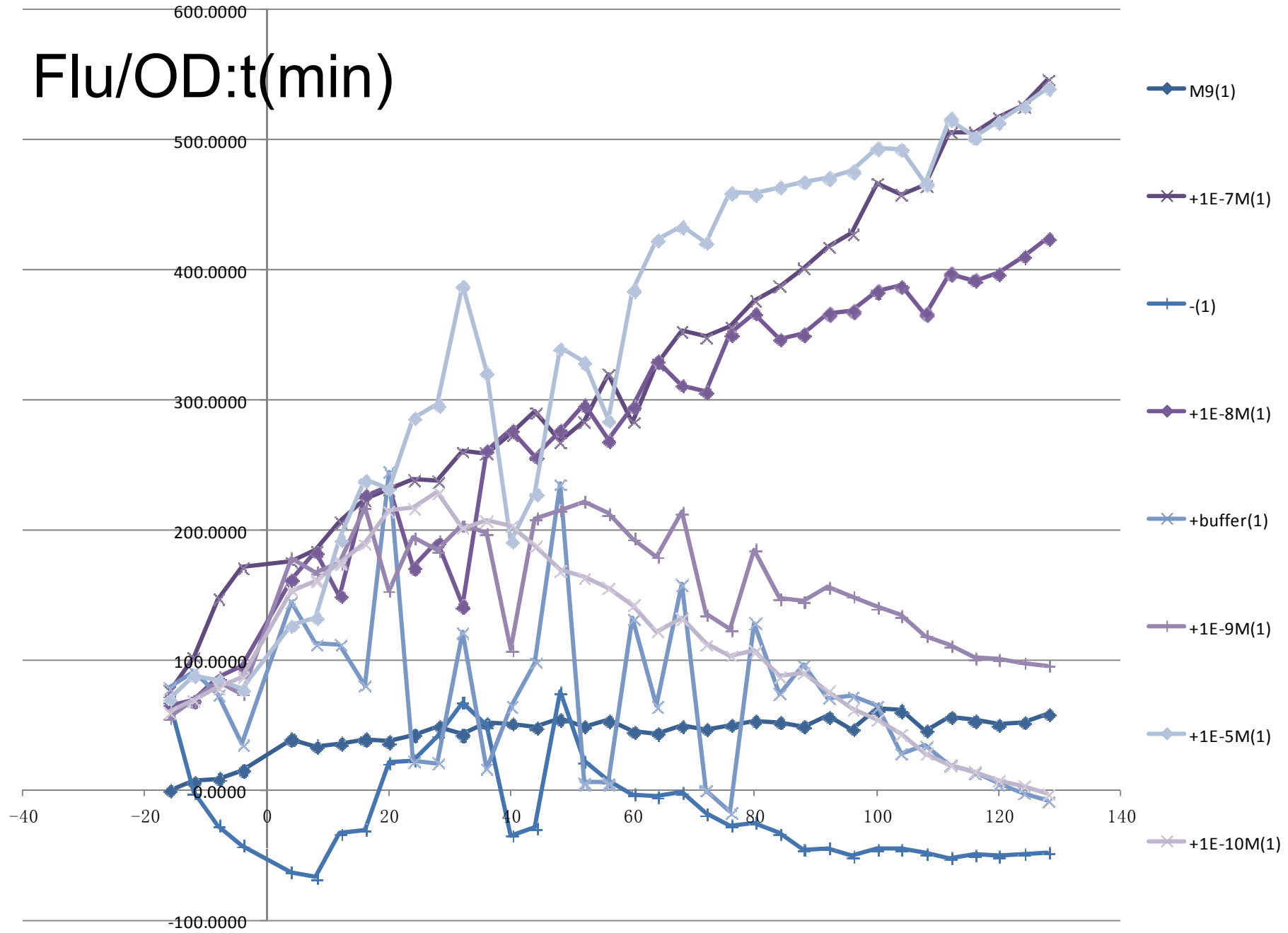

# Flu/OD:t(min)

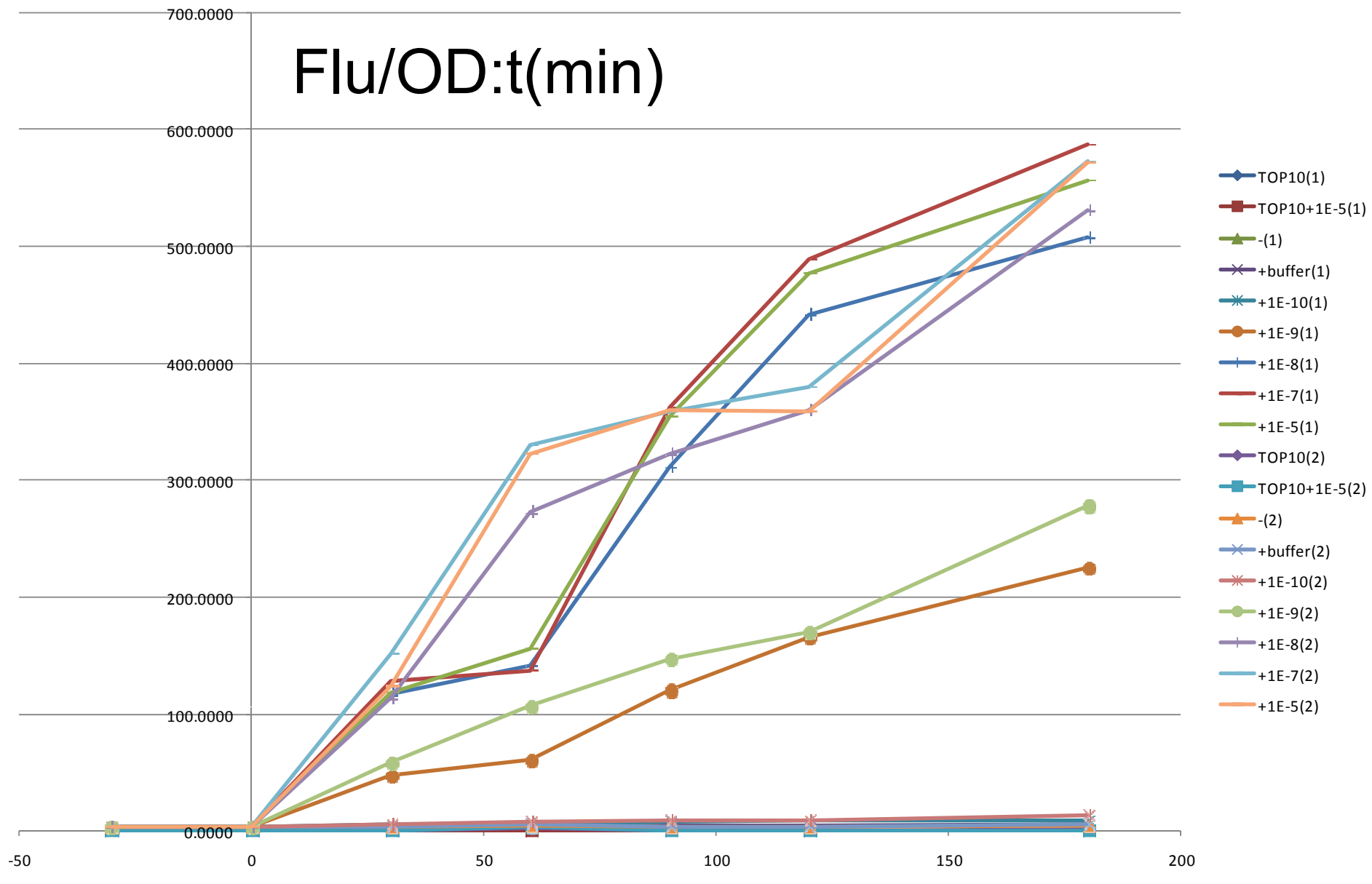

# Flu/OD:t(min)

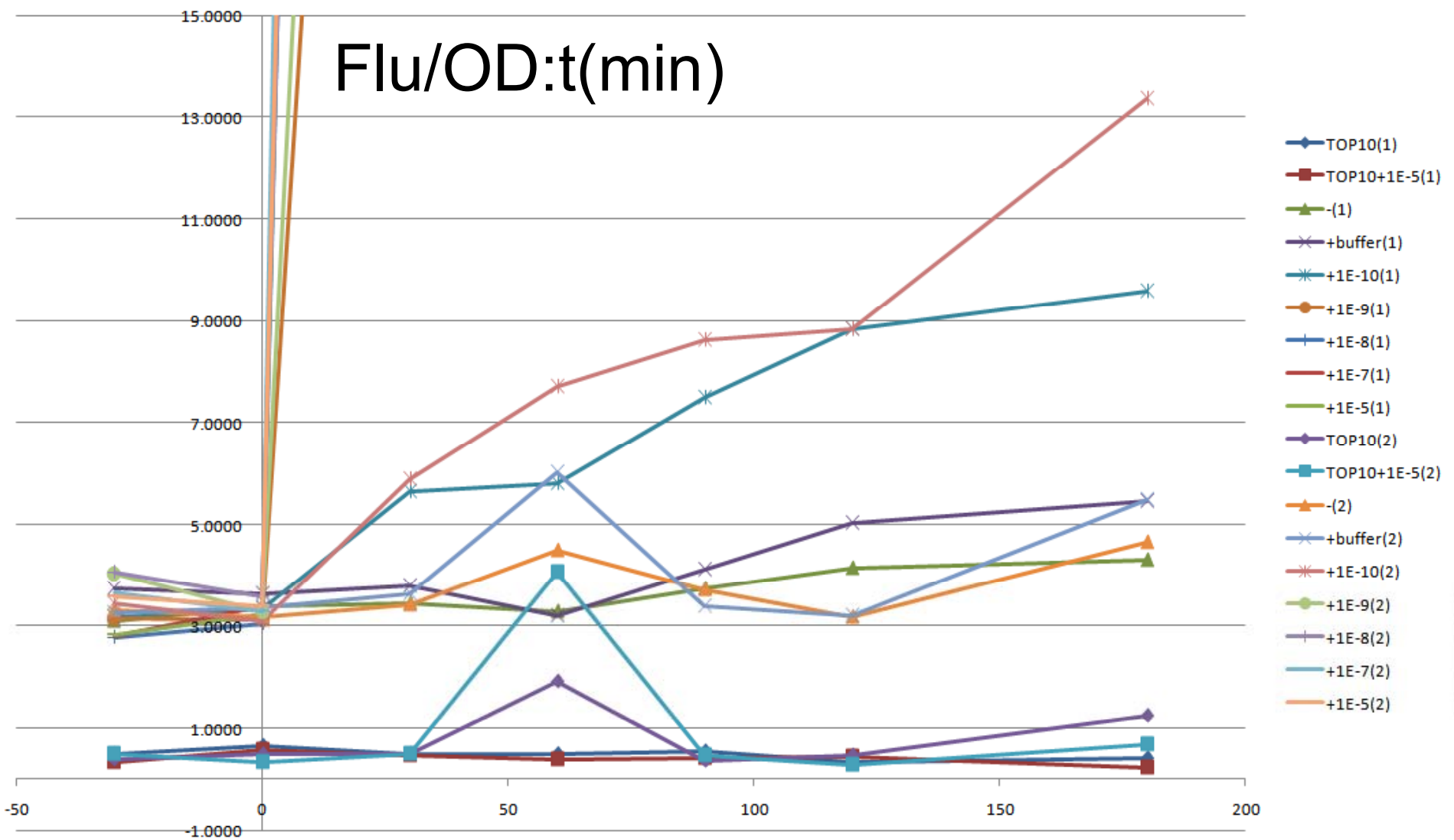

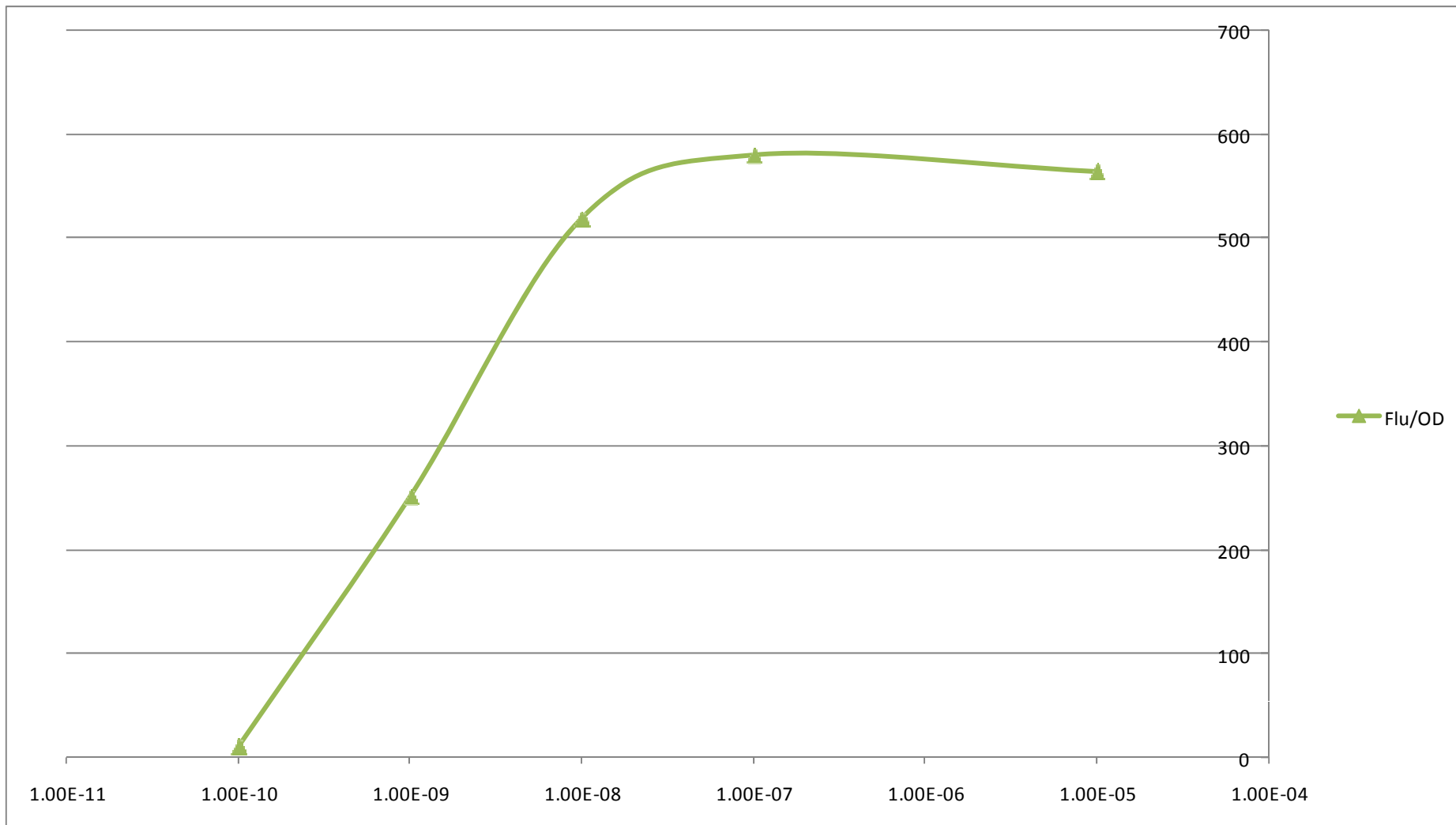

# F2620

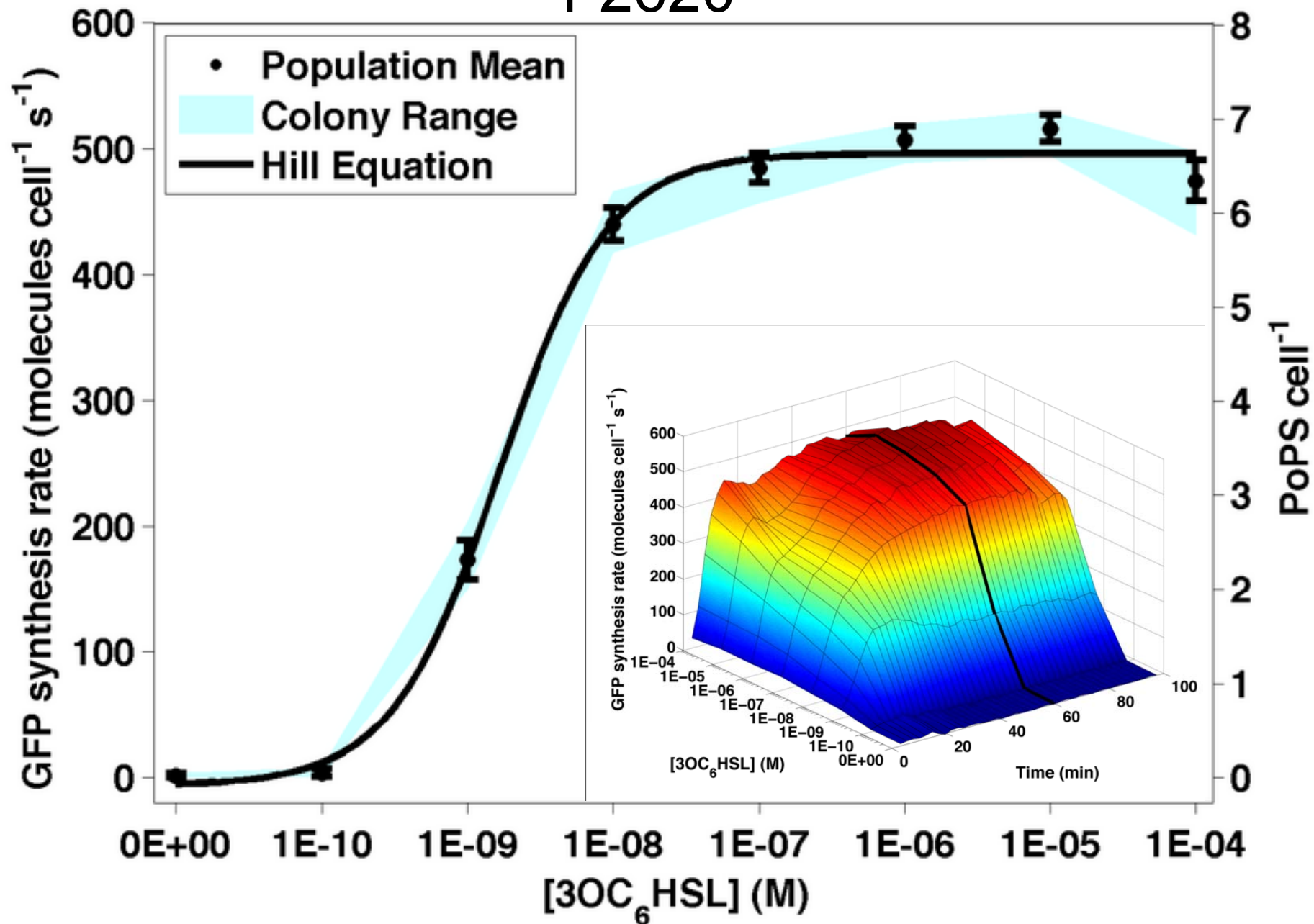

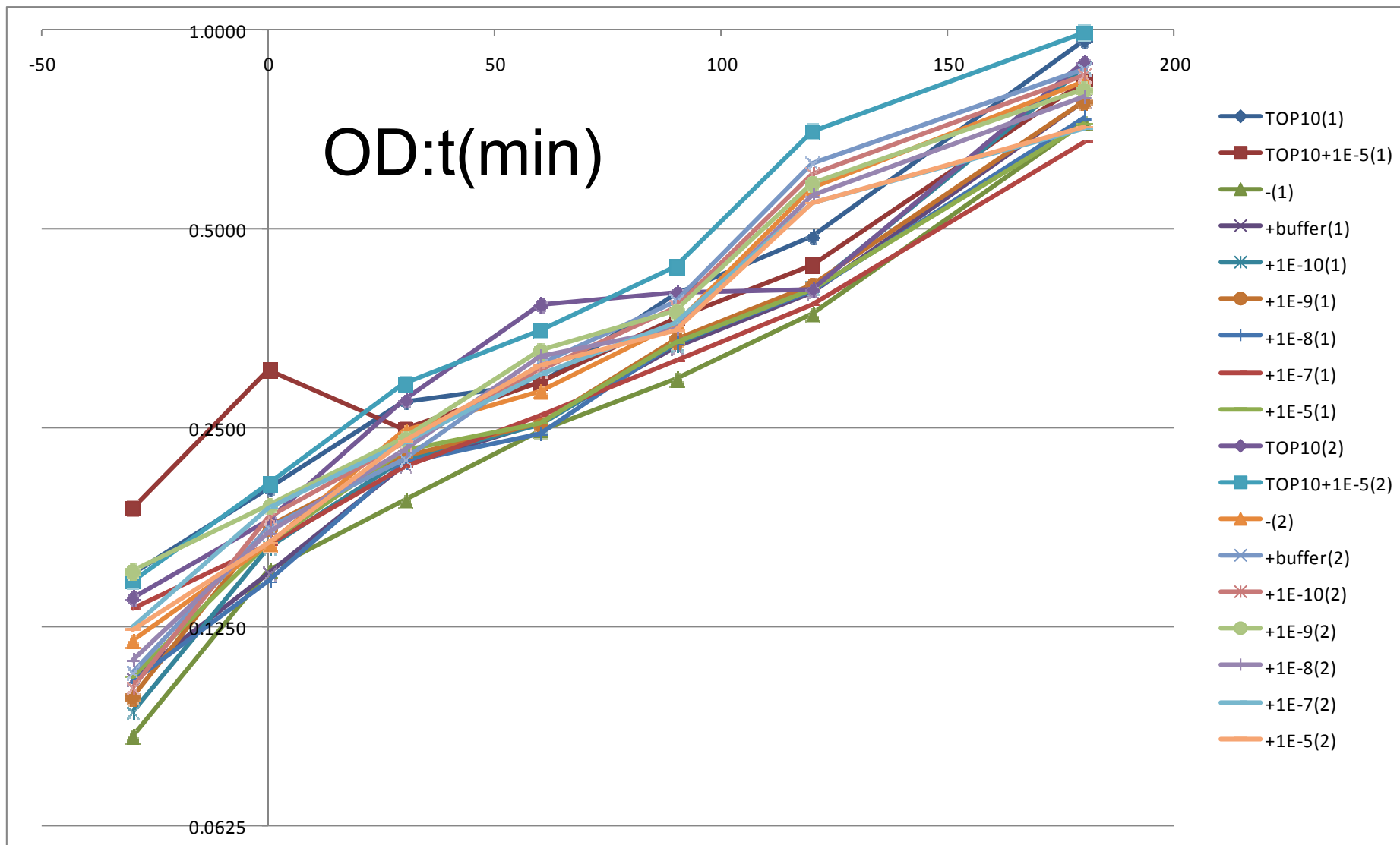

# 9+R+002 (K176126)

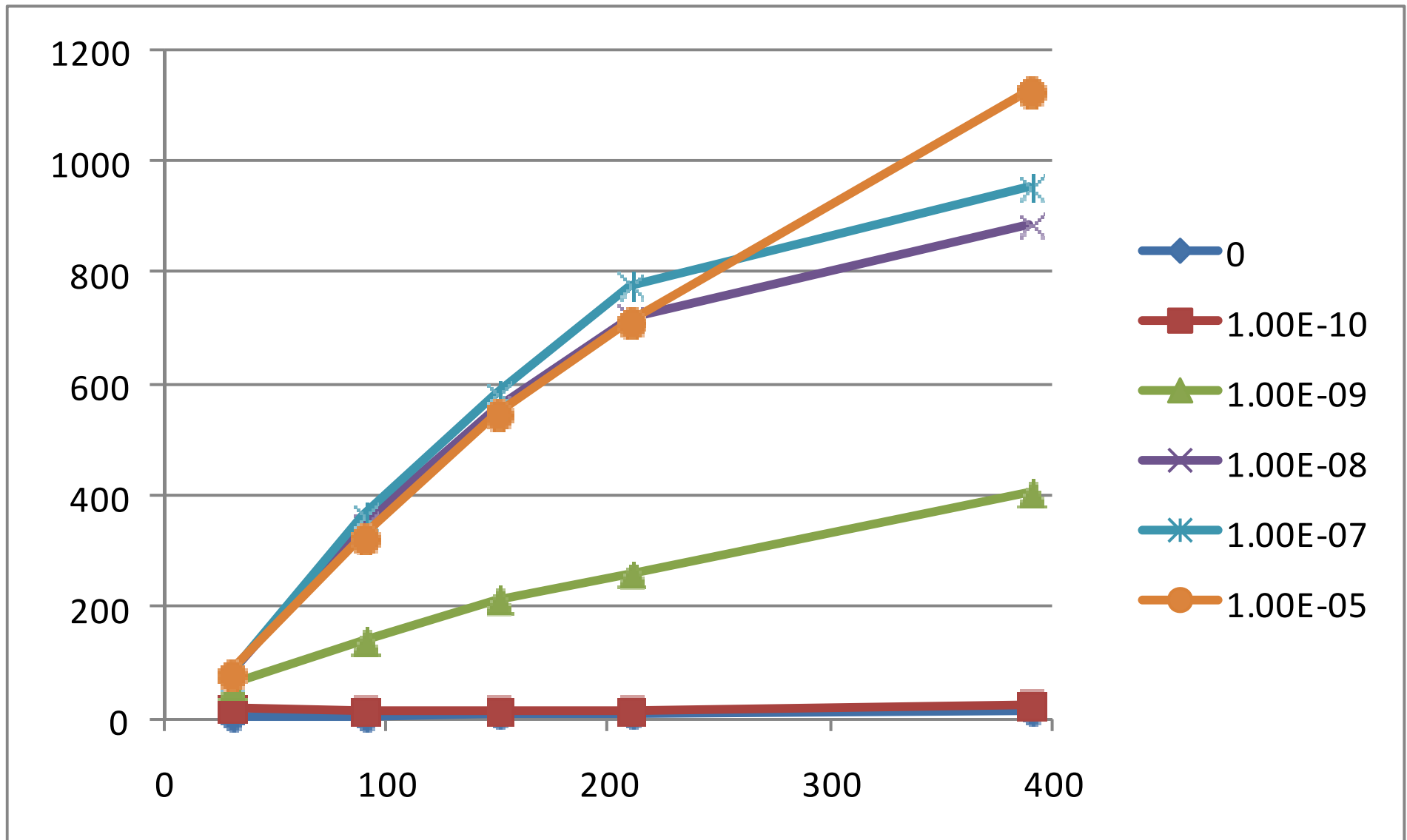

# 10+R+002 (K176130)

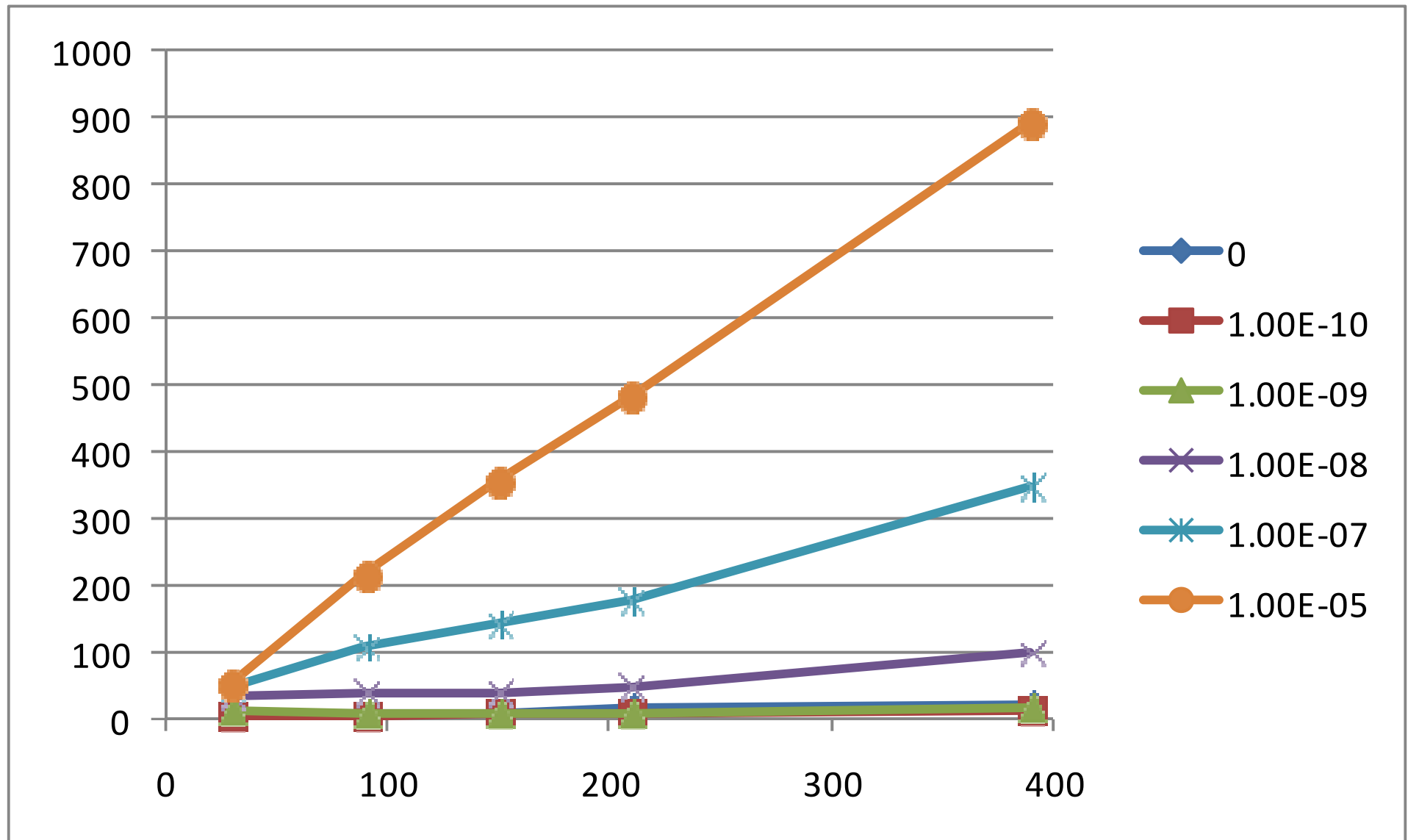



# 11+R+002 (K176128)

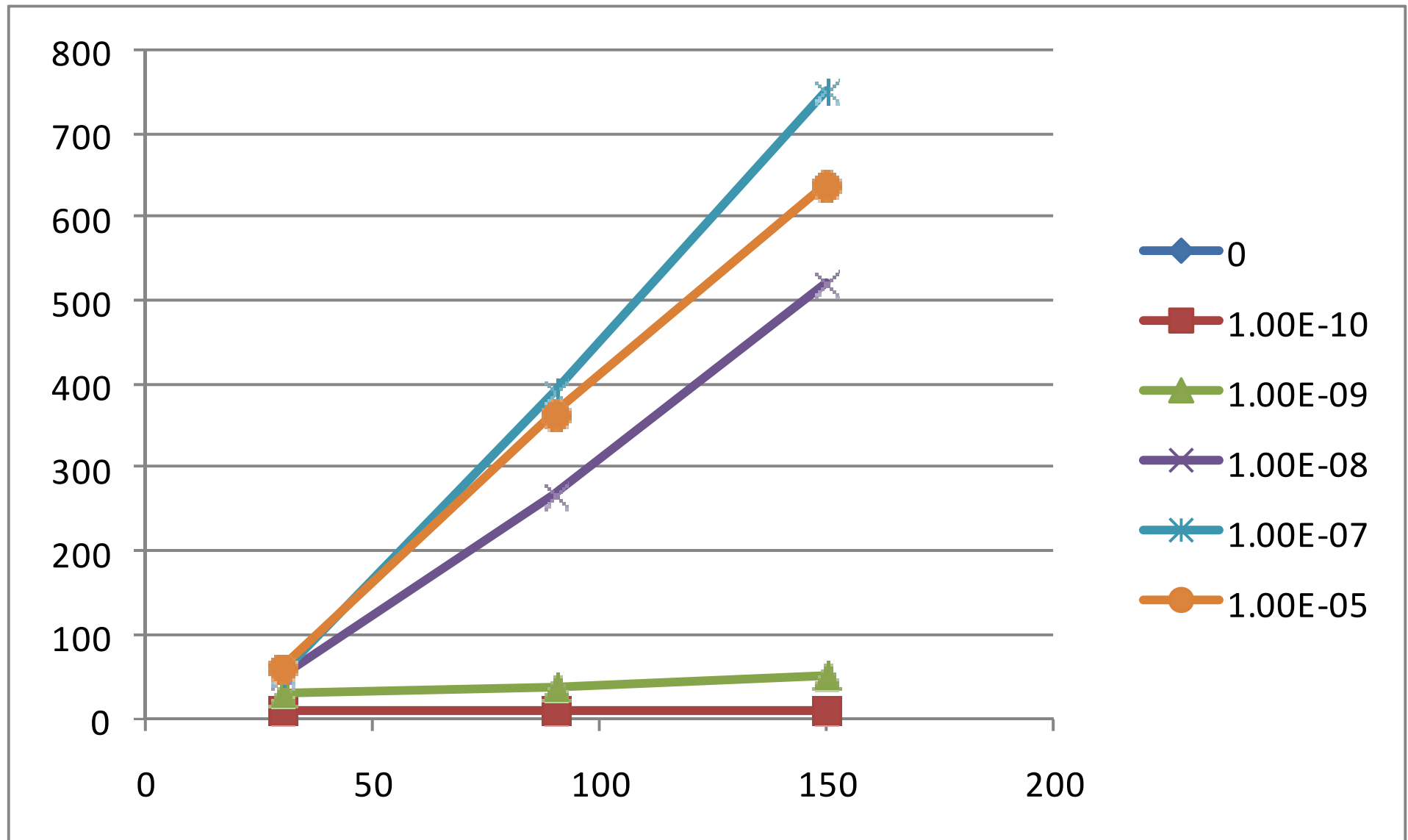

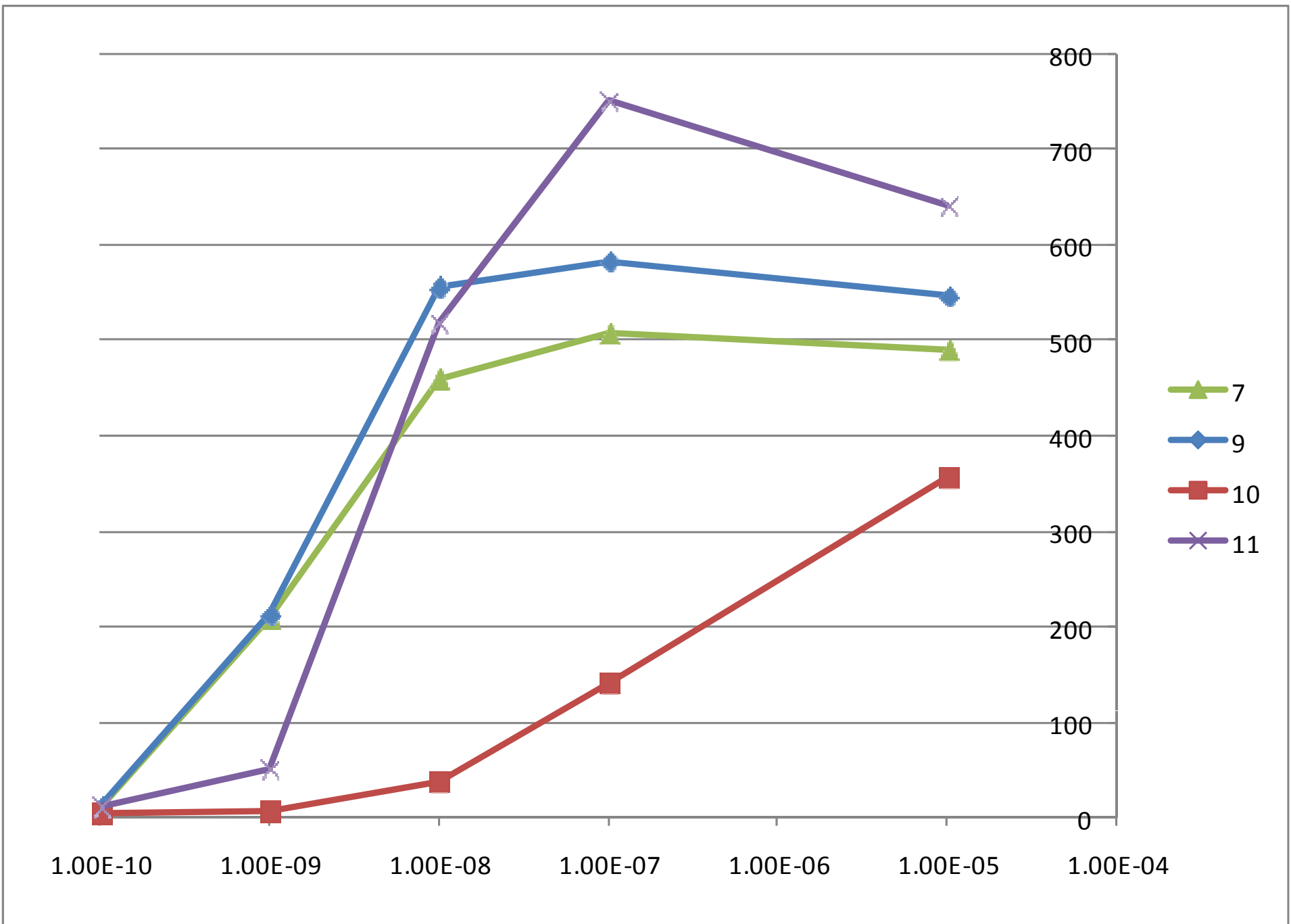

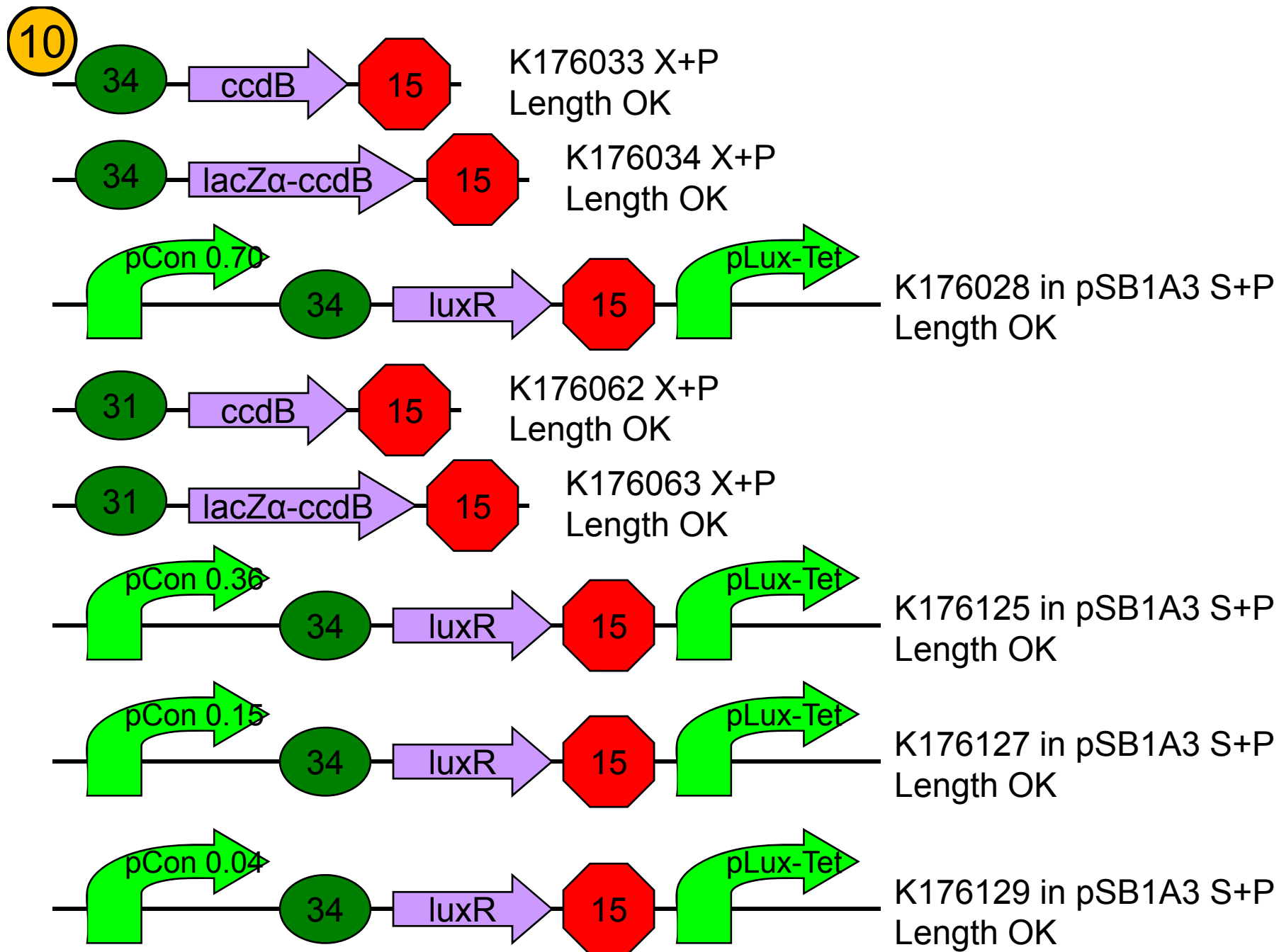

← VRccdB K176058  
Synthesis OK

← M13-47 K176059  
Synthesis OK

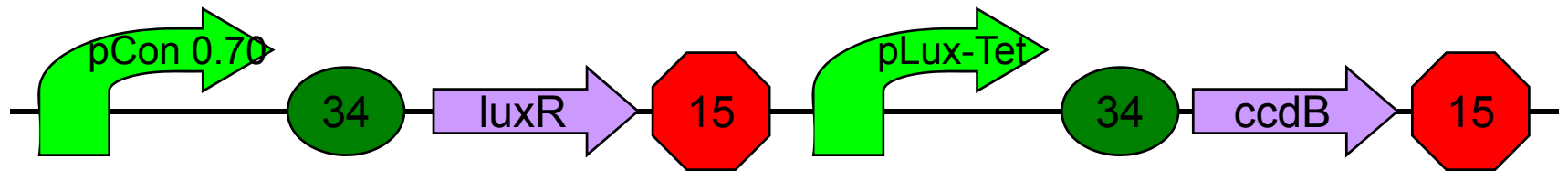

K176035 in pSB1A3 in DB3.1  
Sequence ?

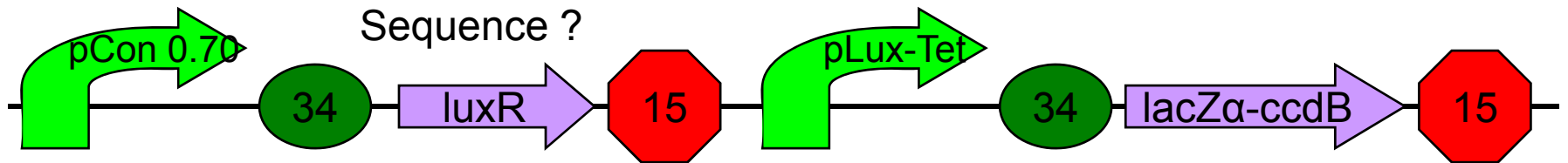

K176036 in pSB1A3 in DB3.1  
Sequence OK

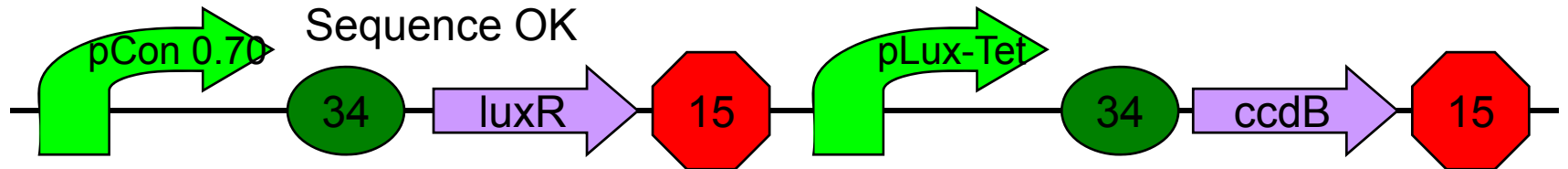

K176035 in pSB1A3 in TOP10  
Transformation Fail

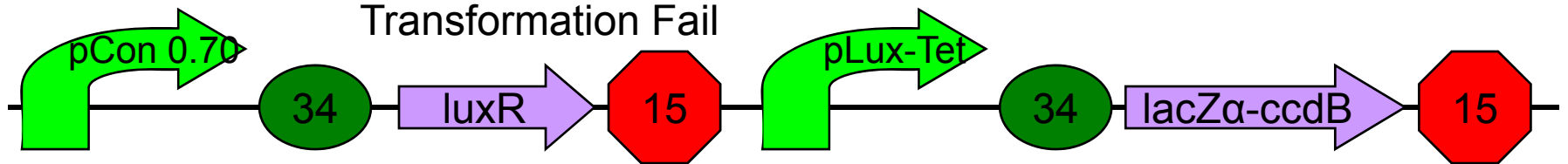

K176036 in pSB1A3 in TOP10  
Transformation Fail

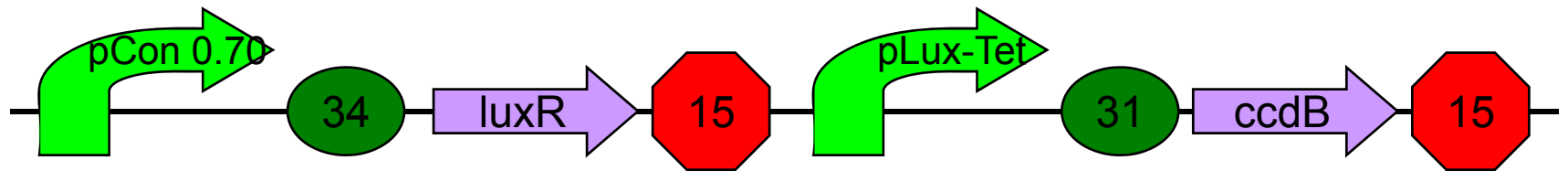

K176089 in pSB1A3 in DB3.1

Sequencing

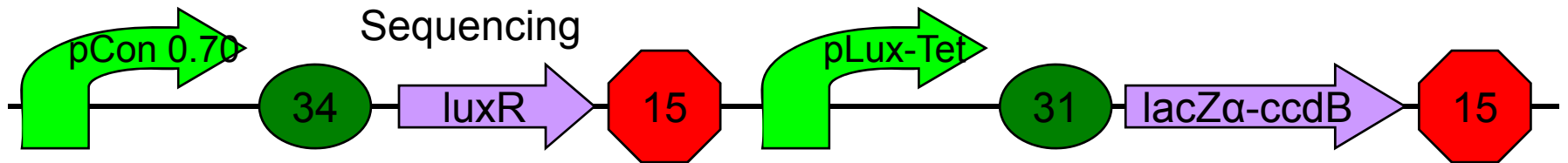

K176090 in pSB1A3 in DB3.1

Sequence ?

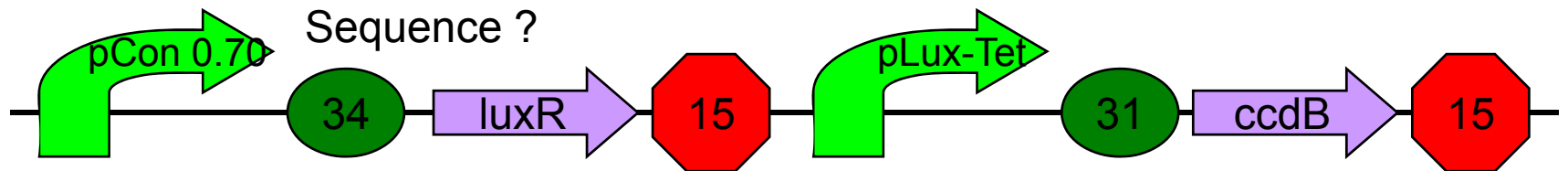

K176089 in pSB1A3 in TOP10

Transformation

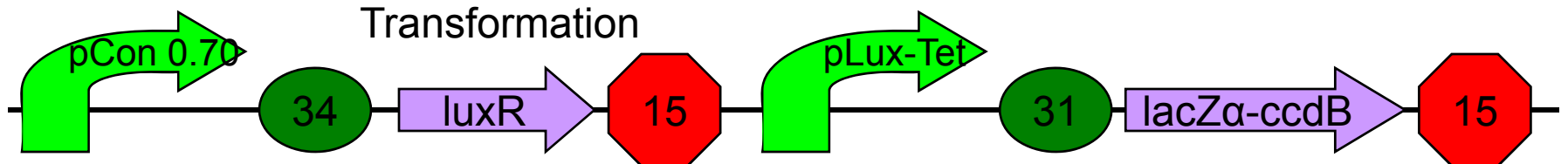

K176090 in pSB1A3 in TOP10

Transformation

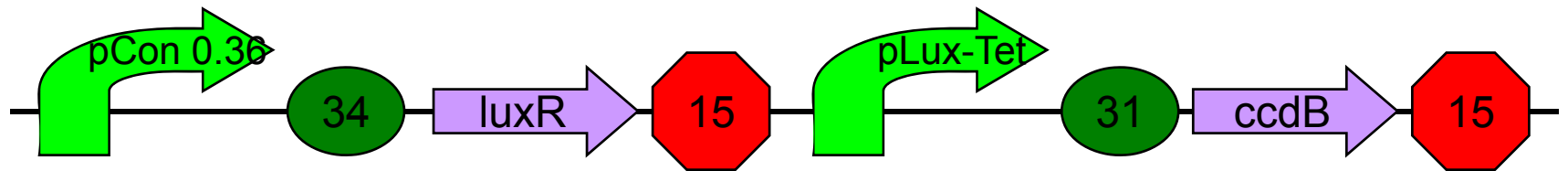

K176131 in pSB1A3 in DB3.1

Sequencing

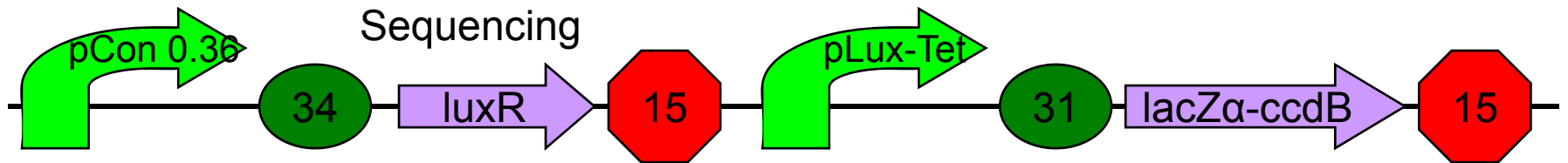

K176132 in pSB1A3 in DB3.1

Sequencing

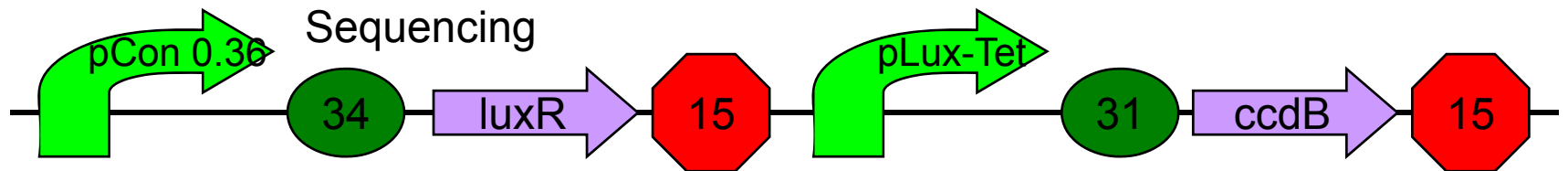

K176131 in pSB1A3 in MDS42rB

Transformation

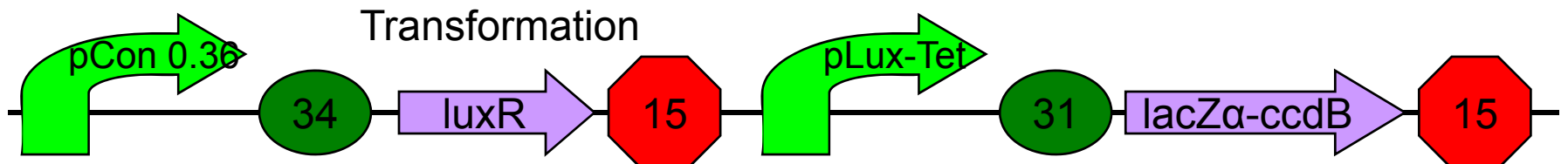

K176132 in pSB1A3 in MDS42rB

Transformation

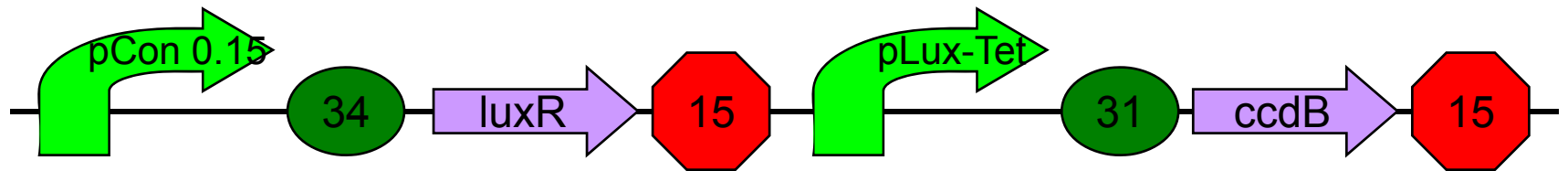

K176185 in pSB1A3 in DB3.1

Sequencing

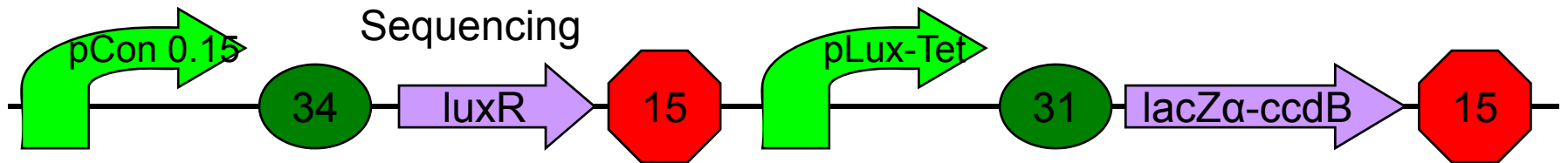

K176186 in pSB1A3 in DB3.1

Sequencing

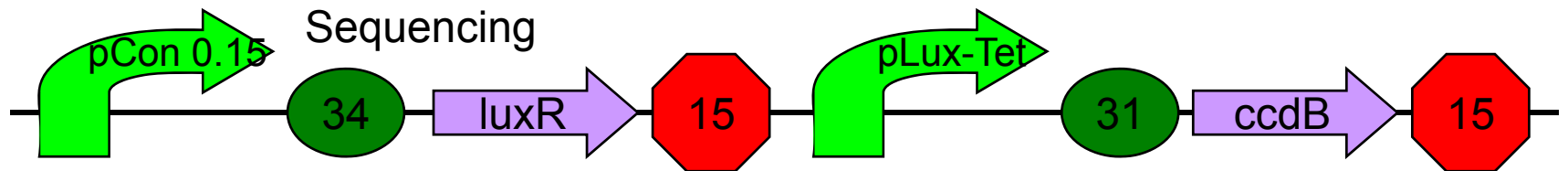

K176185 in pSB1A3 in MDS42rB

Transformation

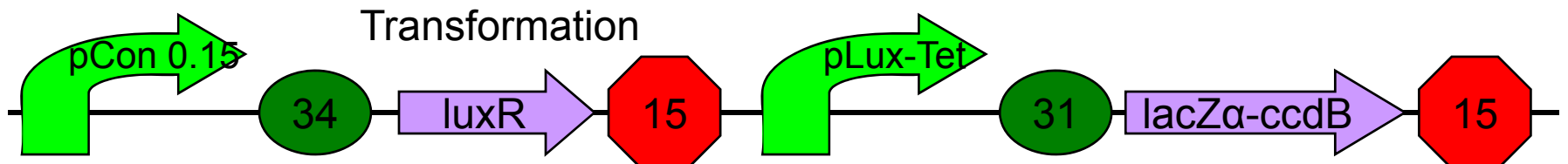

K176186 in pSB1A3 in MDS42rB

Transformation

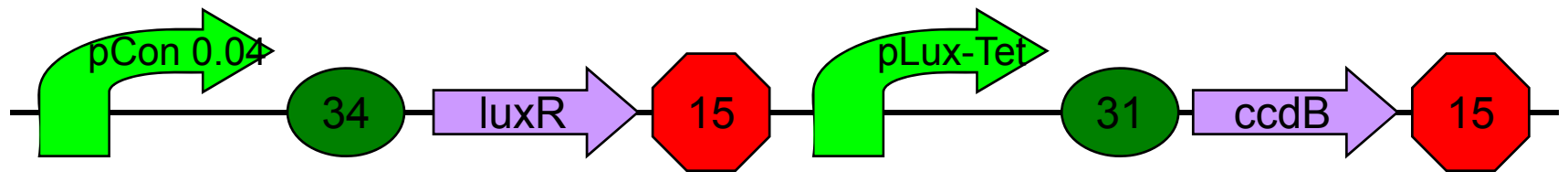

K176187 in pSB1A3 in DB3.1

Sequencing

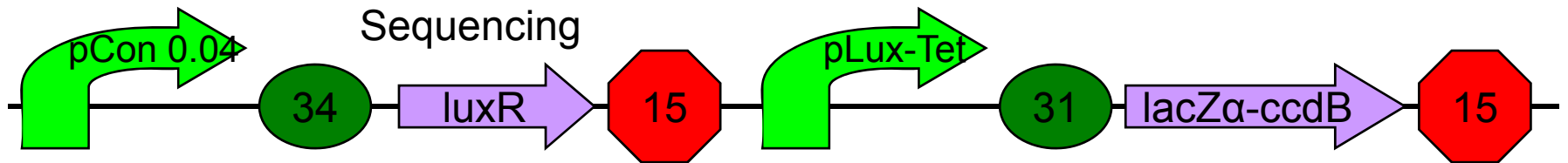

K176188 in pSB1A3 in DB3.1

Sequencing

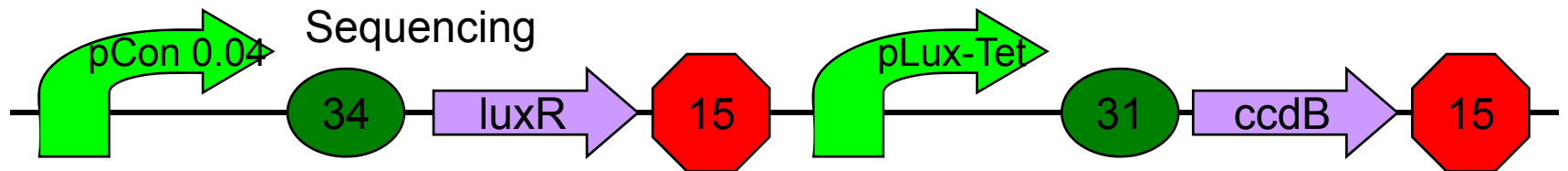

K176187 in pSB1A3 in MDS42rB

Transformation

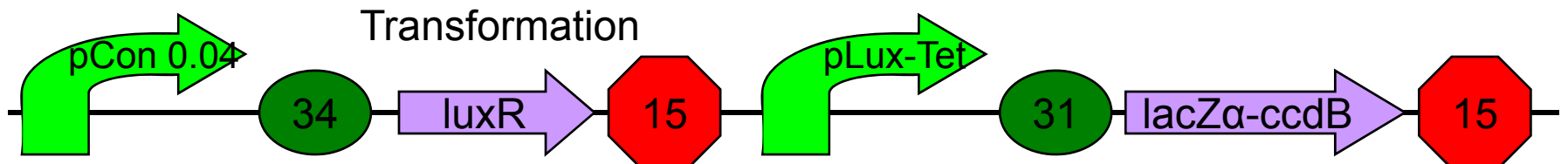

K176188 in pSB1A3 in MDS42rB

Transformation



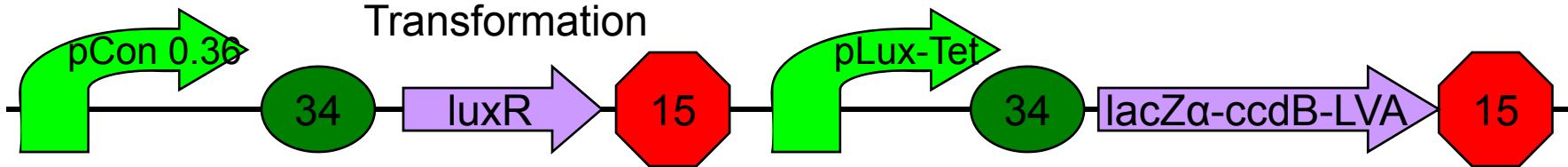
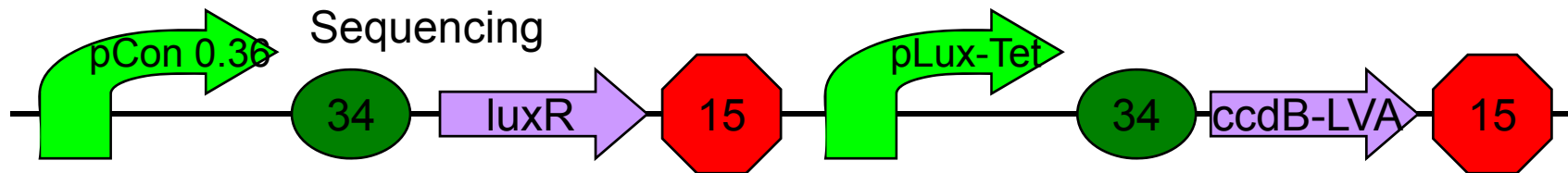
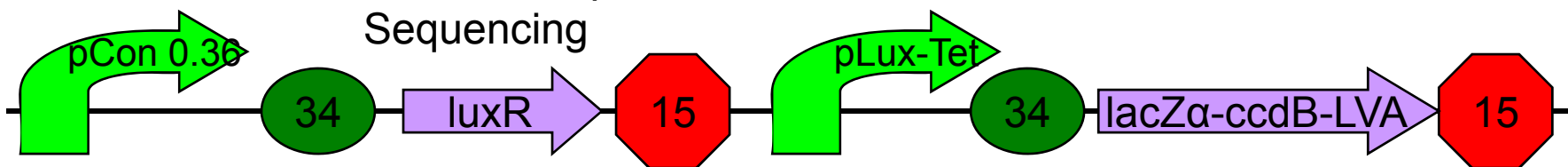
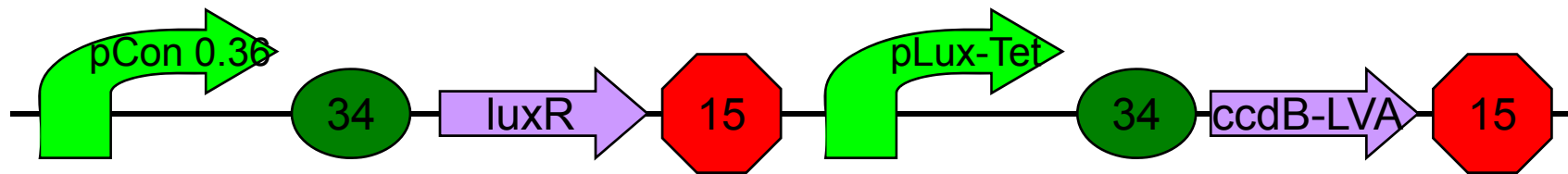
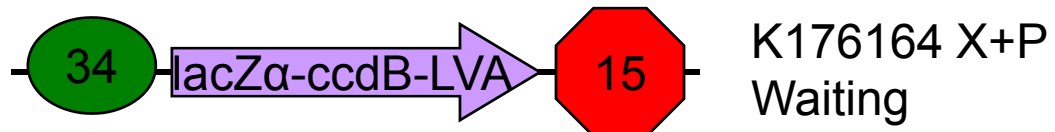
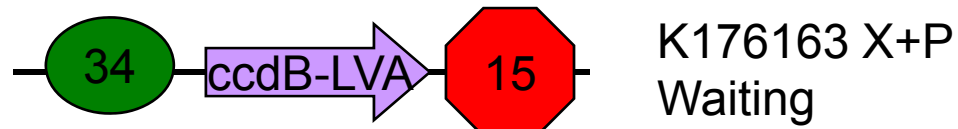

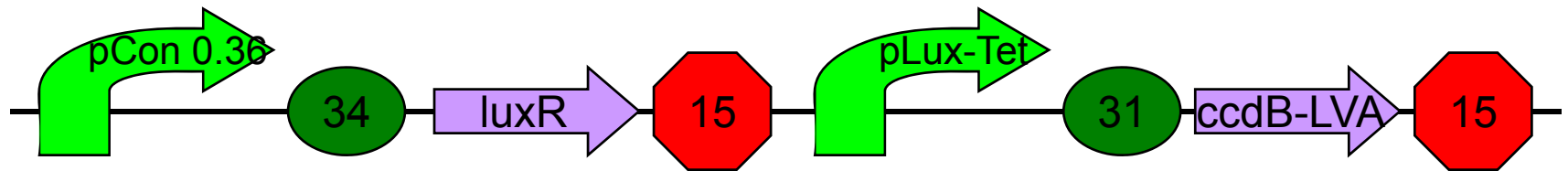
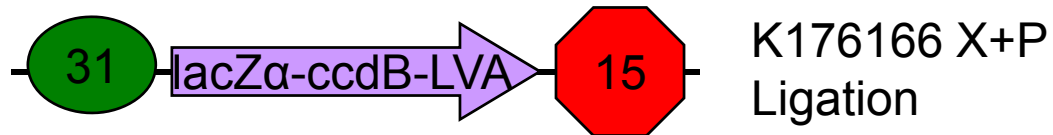
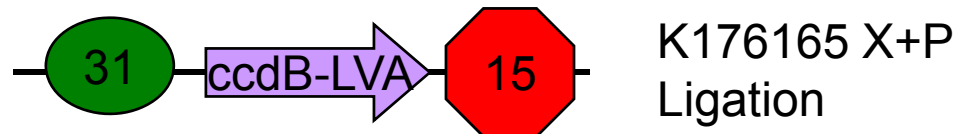

K176169 in pSB1A3 in DB3.1  
Sequencing

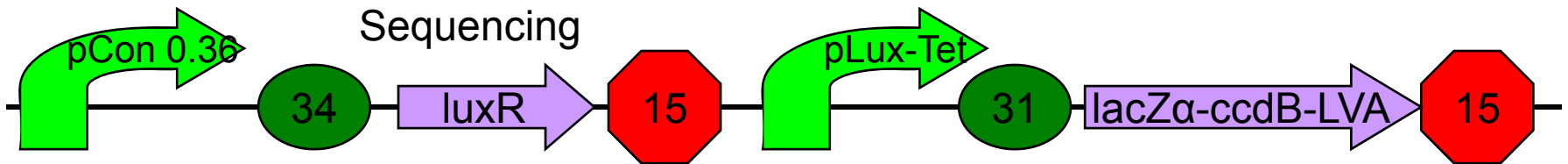

K176170 in pSB1A3 in DB3.1  
Sequencing

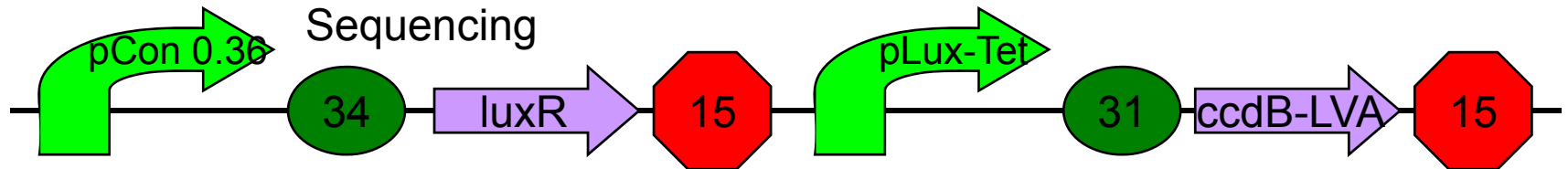

K176169 in pSB1A3 in MDS42rB  
Transformation

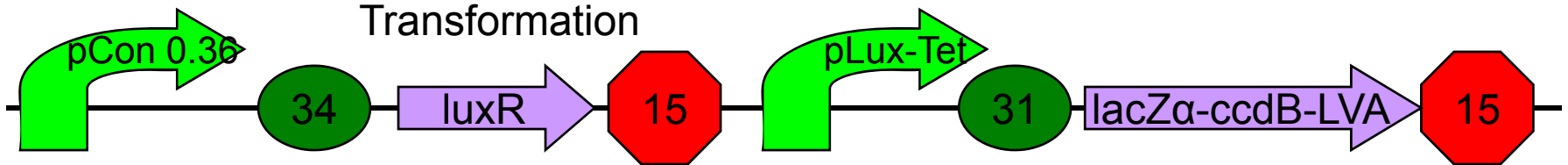

K176170 in pSB1A3 in MDS42rB  
Transformation

11

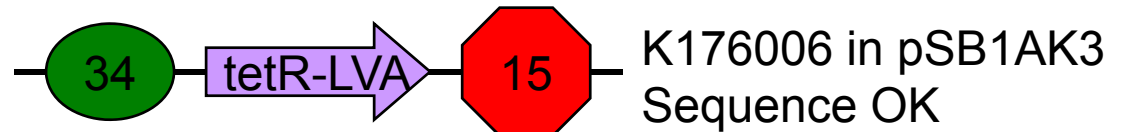
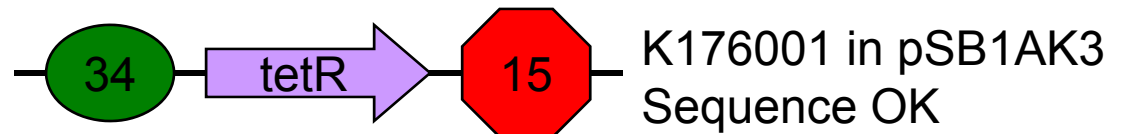
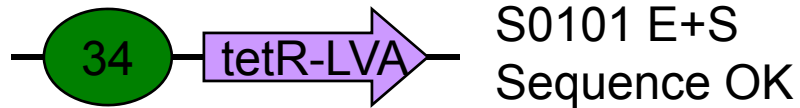
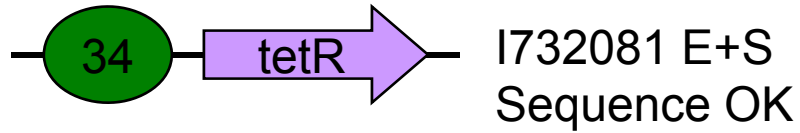
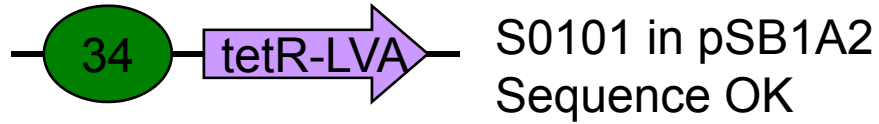
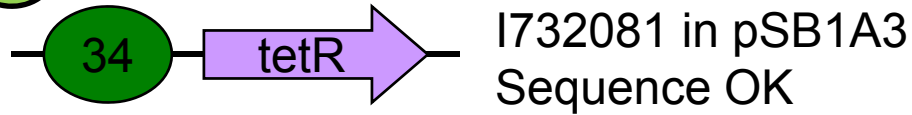

12

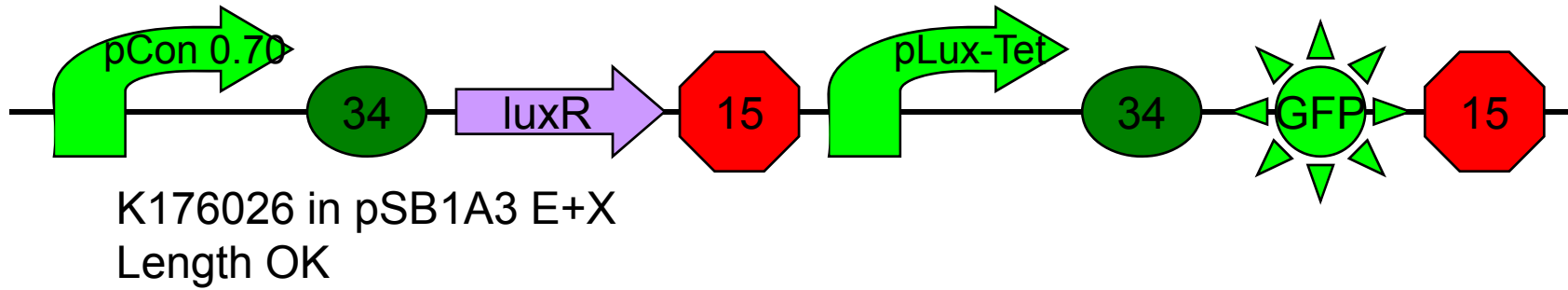
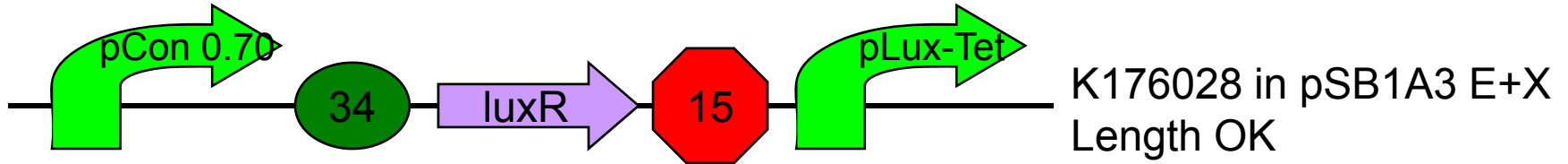
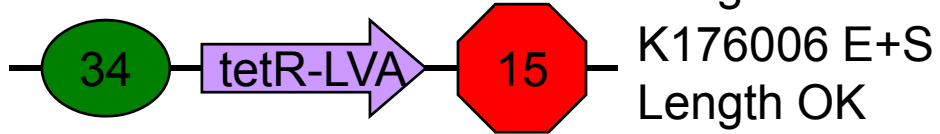
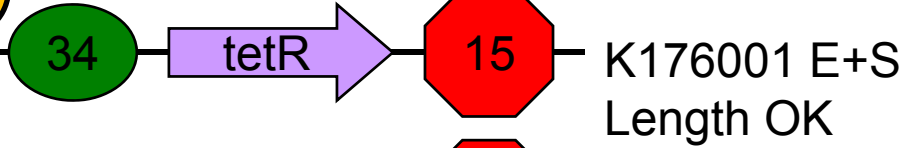



K176057  
Synthesis OK

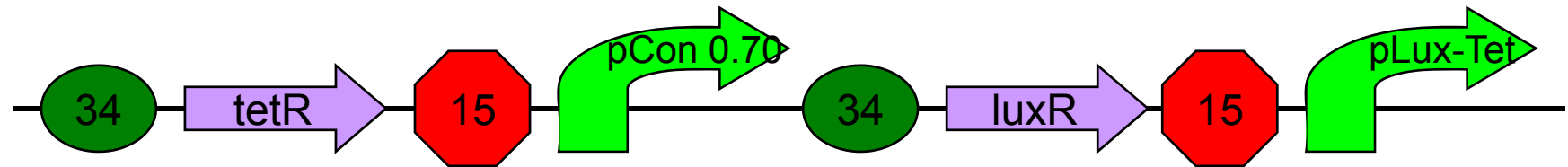

K176031 in pSB1A3  
Sequence OK

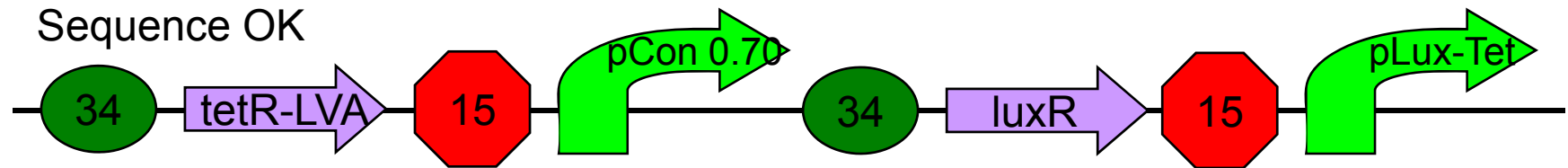

K176032 in pSB1A3  
Sequence OK

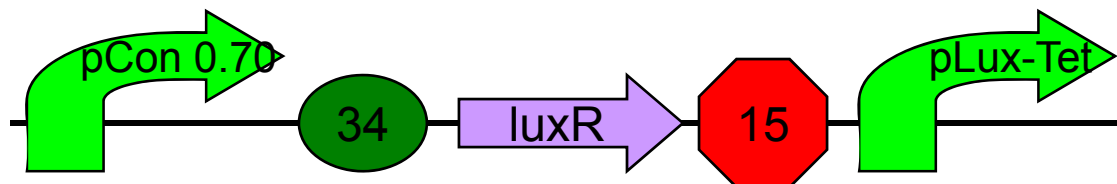
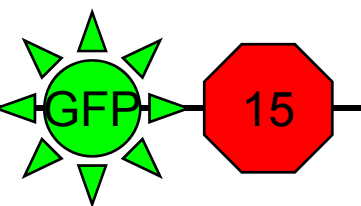
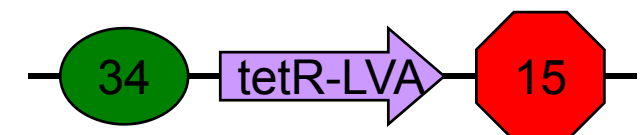
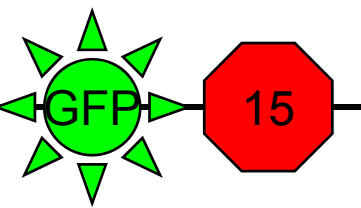
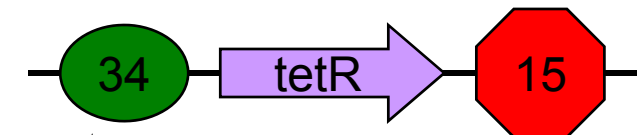

K176029 in pSB1A3  
Sequence ?

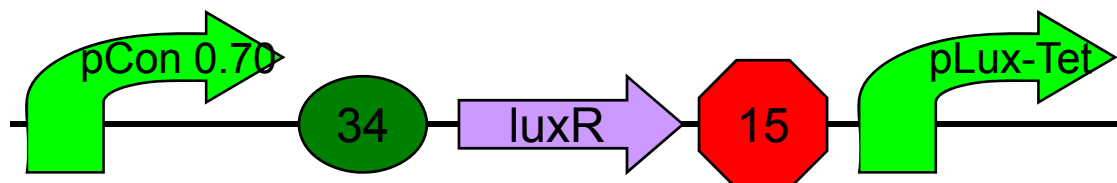

K176030 in pSB1A3  
Sequence ?

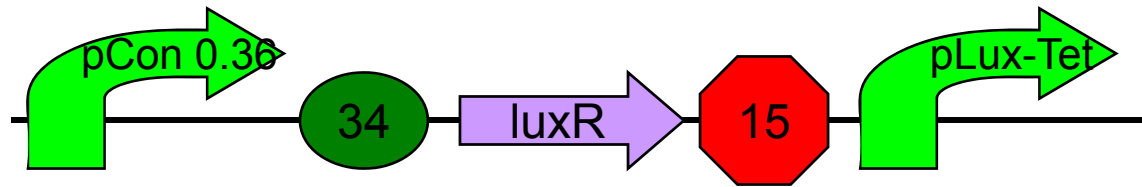

K176125 in pSB1A3  
Digestion

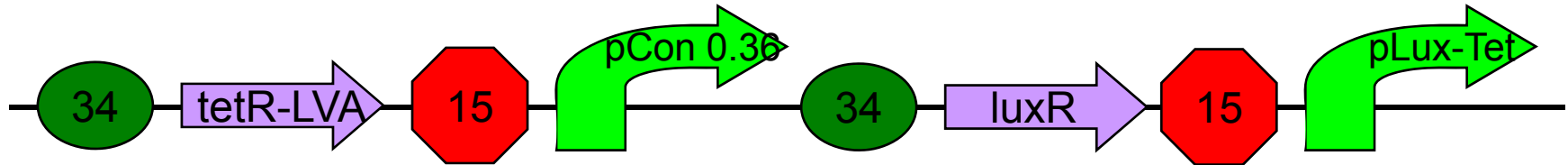

K176133 in pSB1A3  
Ligation

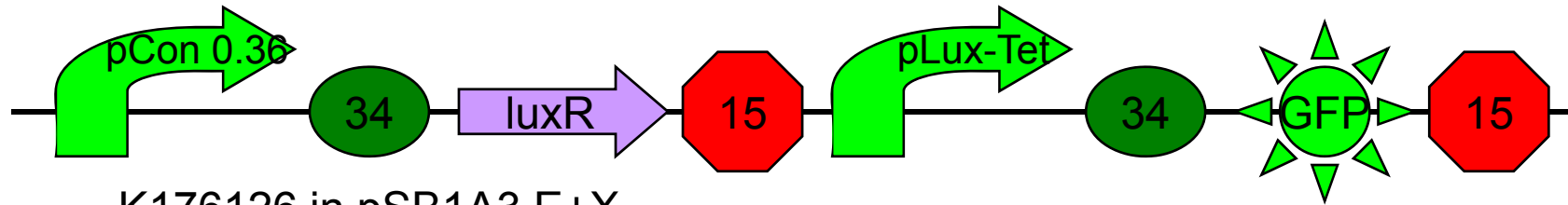

K176126 in pSB1A3 E+X  
Length OK

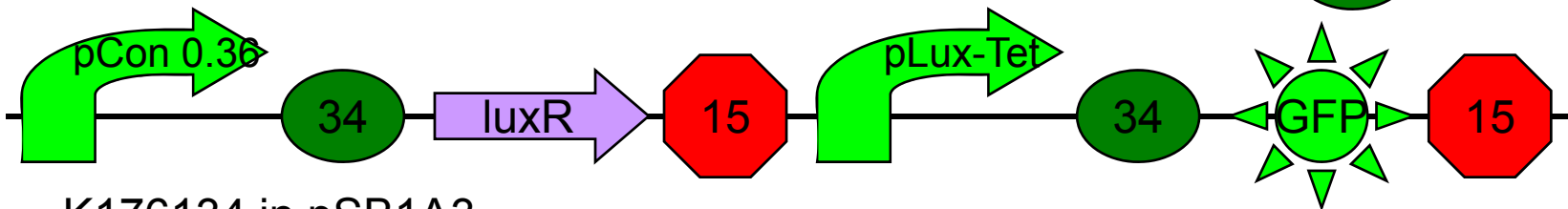

K176134 in pSB1A3  
Sequencing

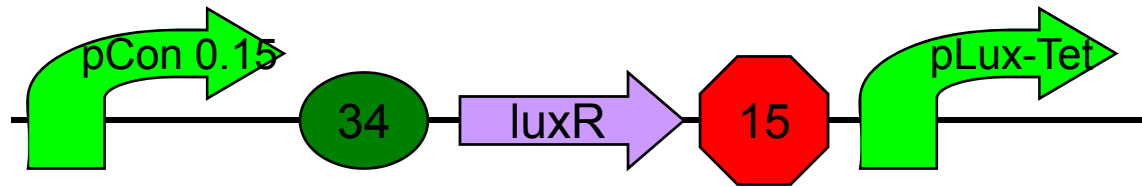

K176127 in pSB1A3  
Digestion

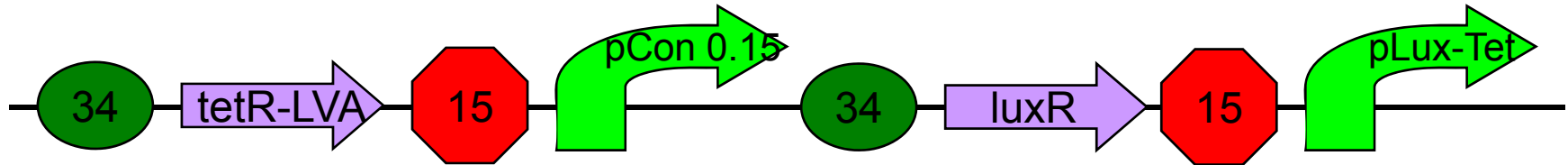

K176171 in pSB1A3  
Ligation

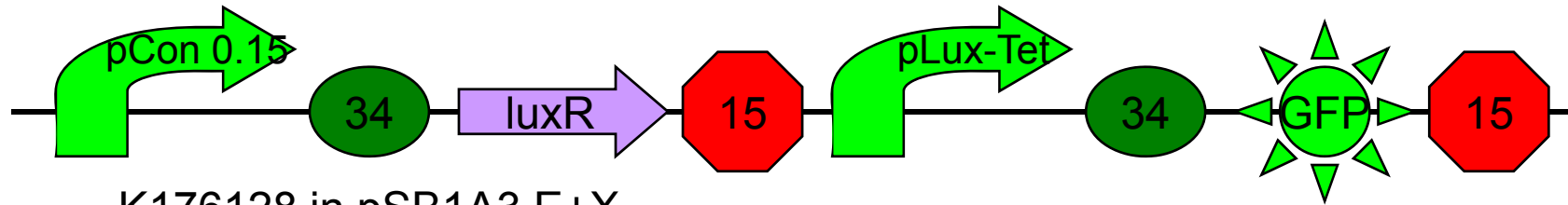

K176128 in pSB1A3 E+X  
Length OK

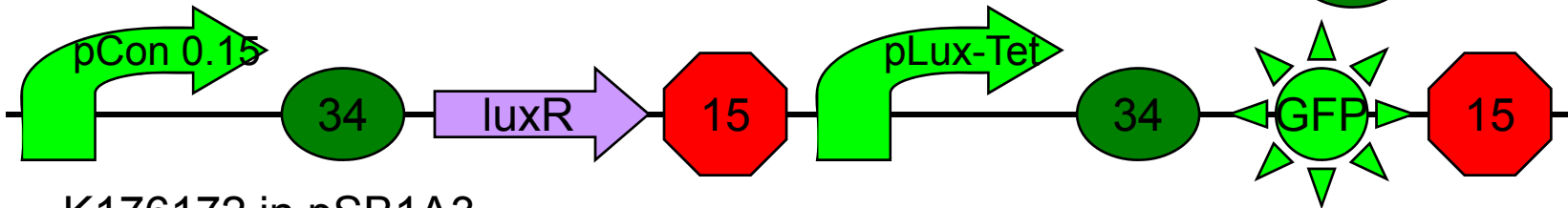

K176172 in pSB1A3  
Sequencing

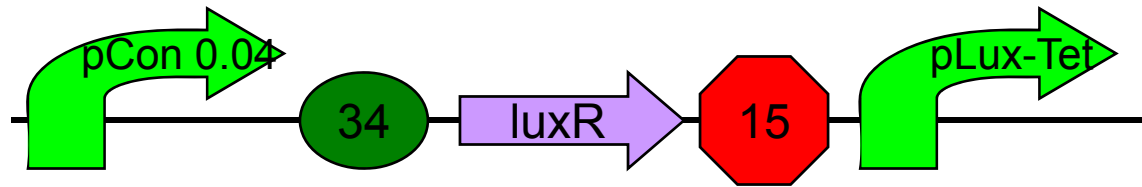

K176129 in pSB1A3  
Digestion

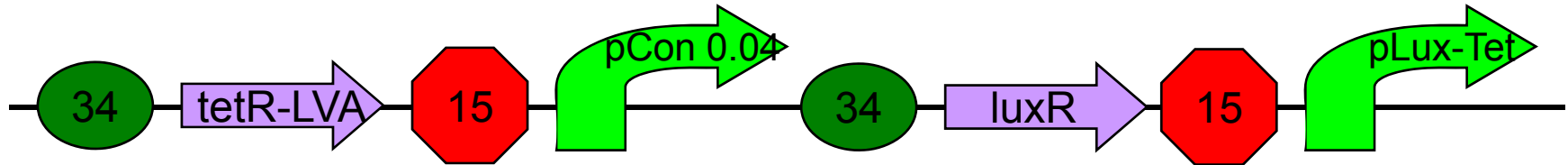

K176173 in pSB1A3  
Ligation

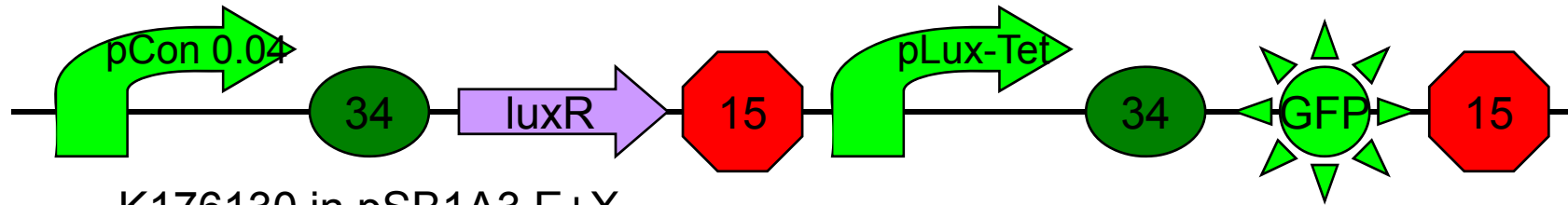

K176130 in pSB1A3 E+X  
Length OK

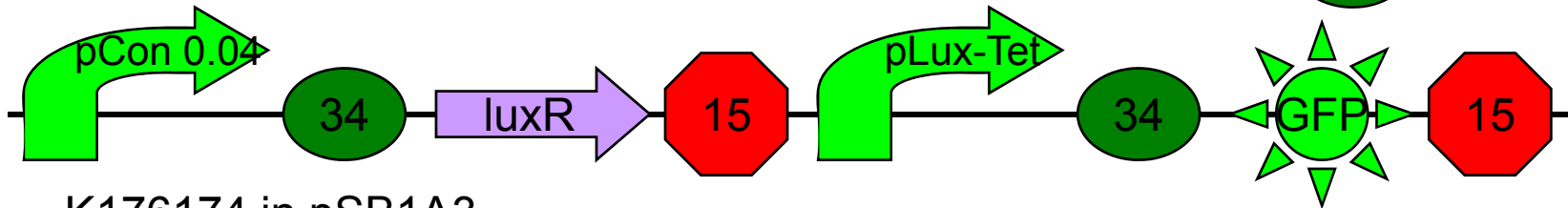

K176174 in pSB1A3  
Sequencing



13

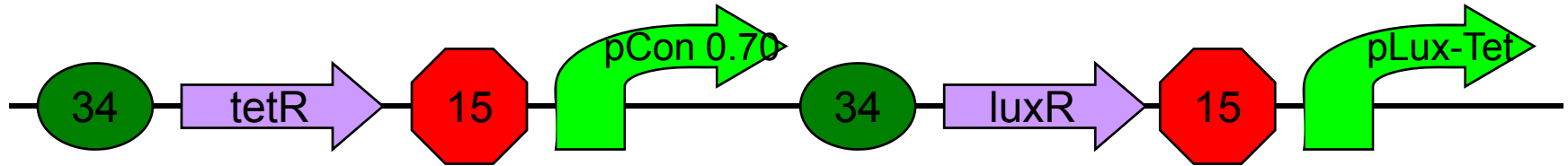

K176031 X+P  
Length OK

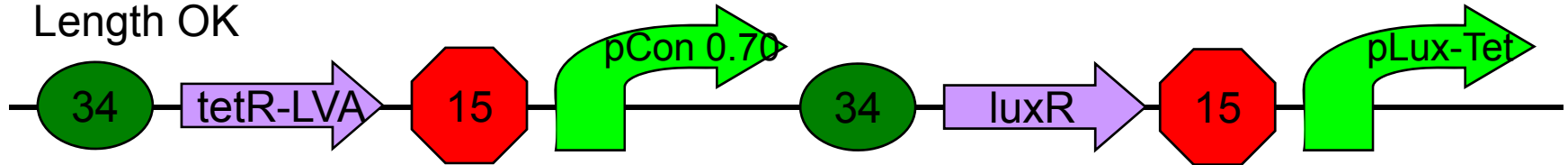

K176032 X+P  
Length OK

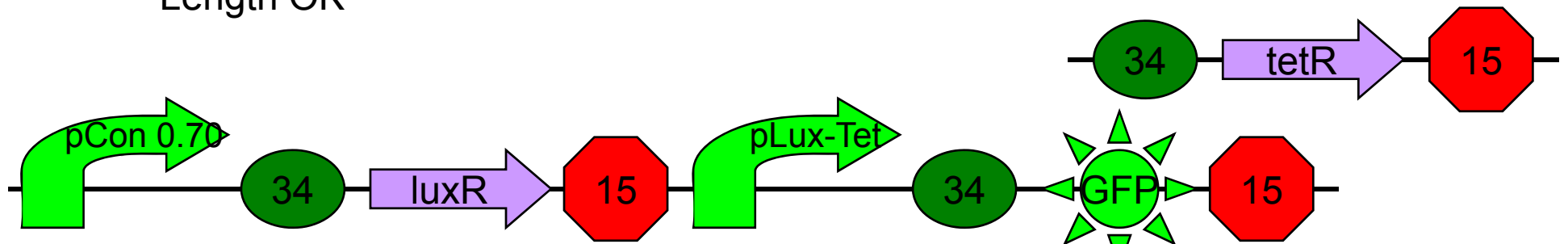

K176029 X+P  
Length OK

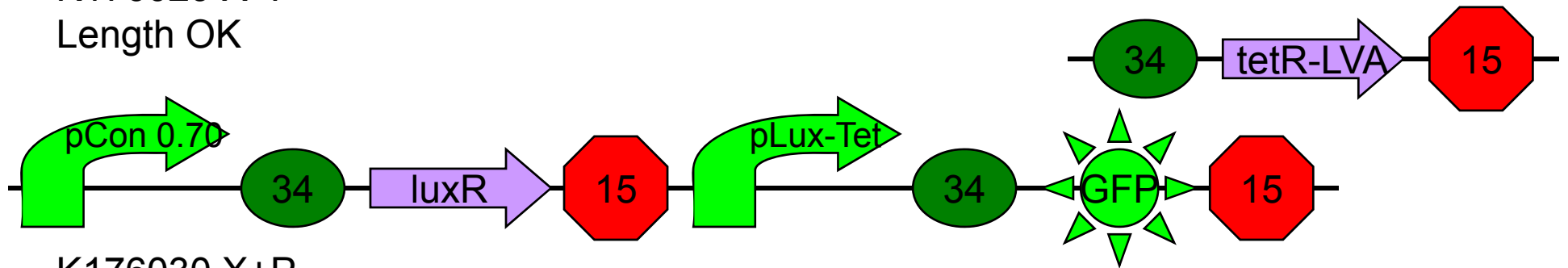

K176030 X+P  
Length OK

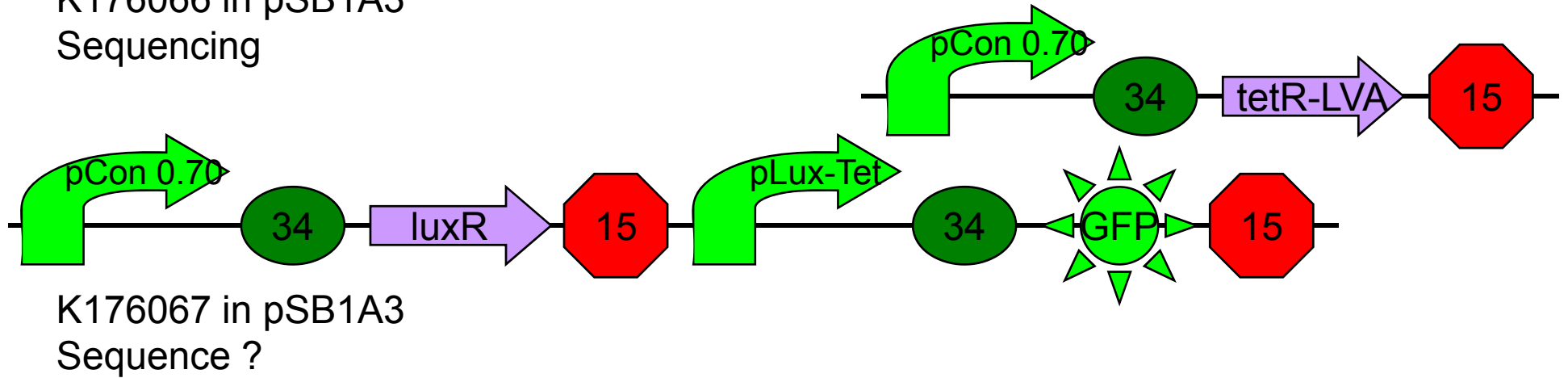
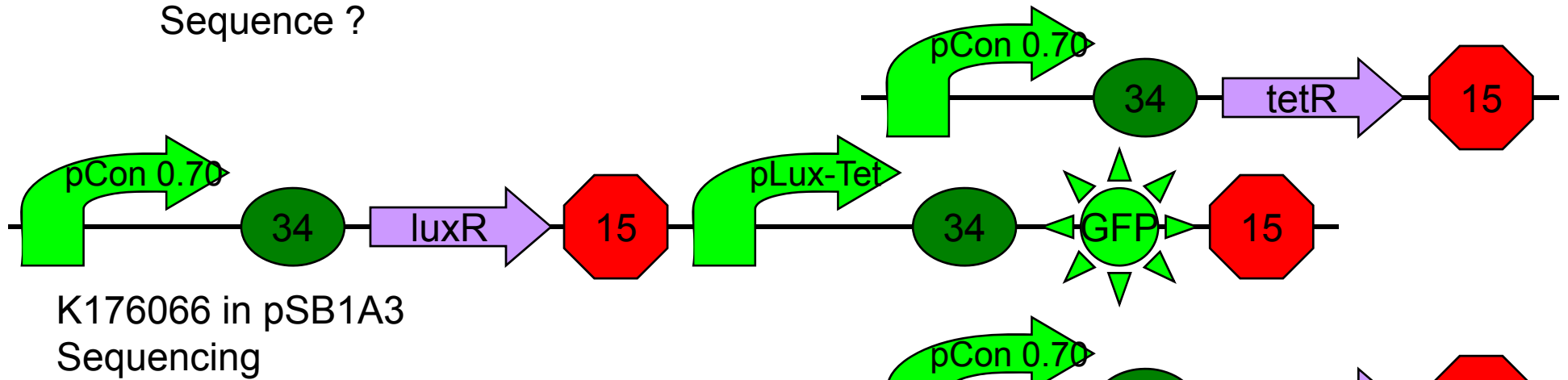
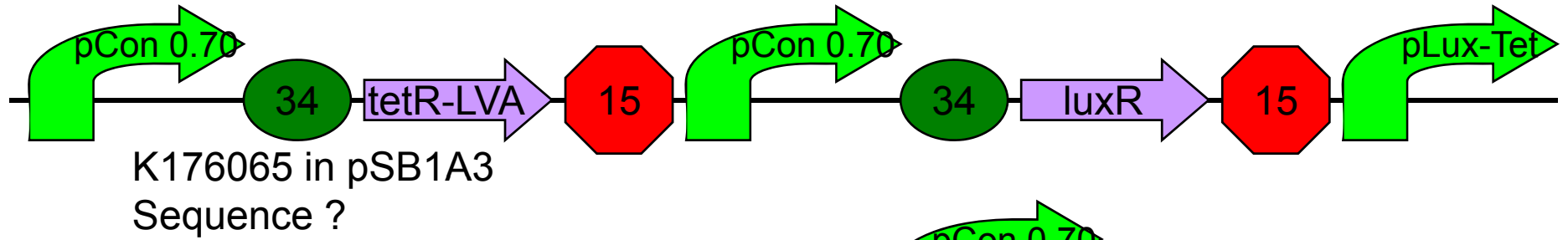
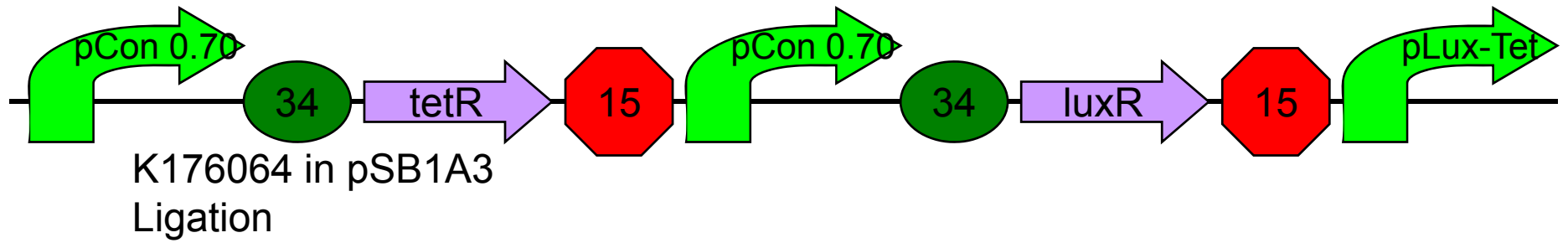

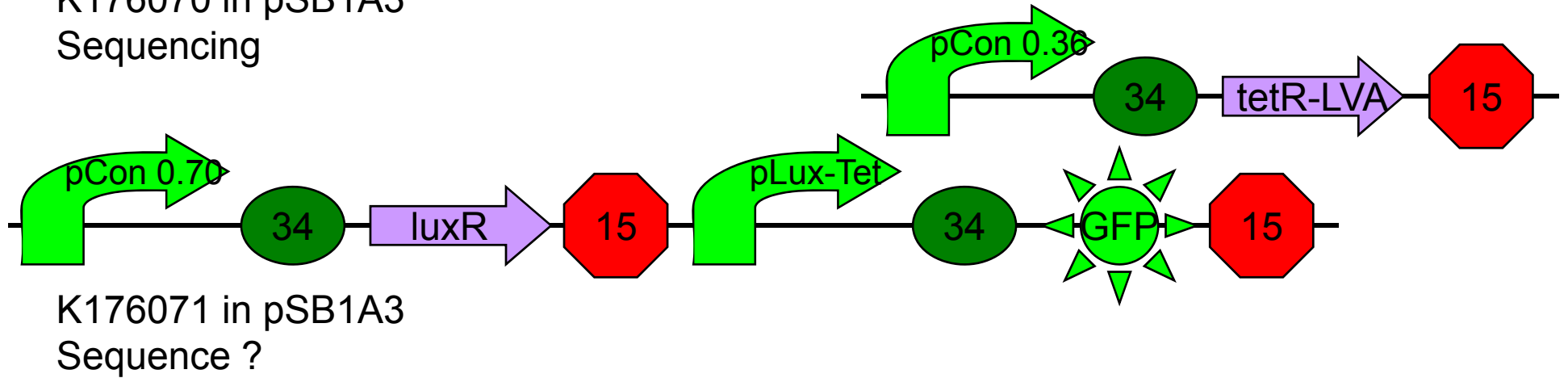
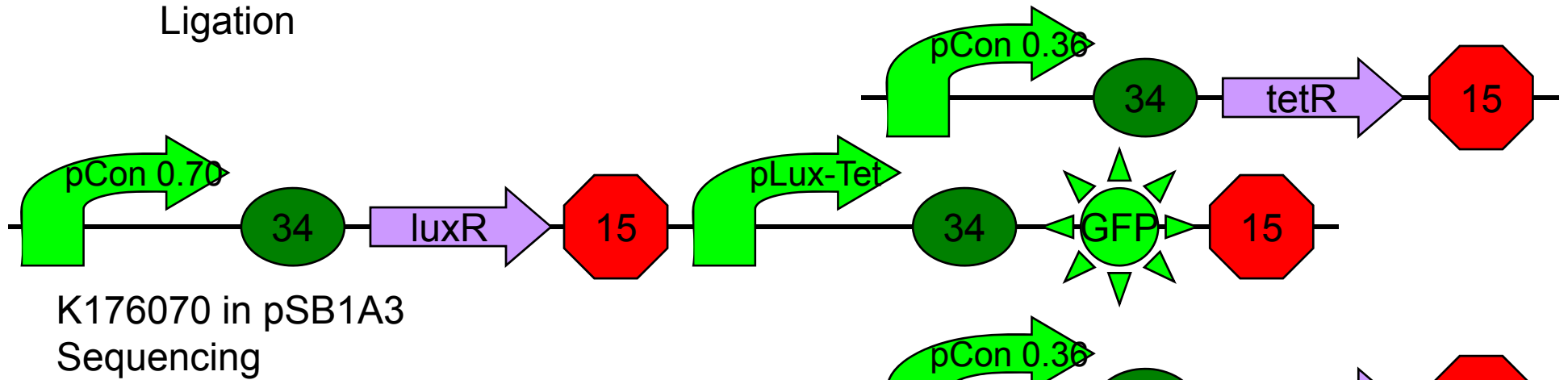
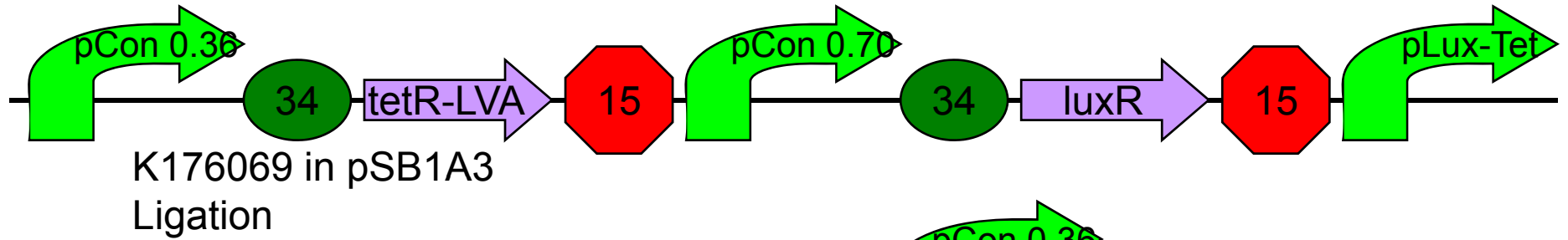
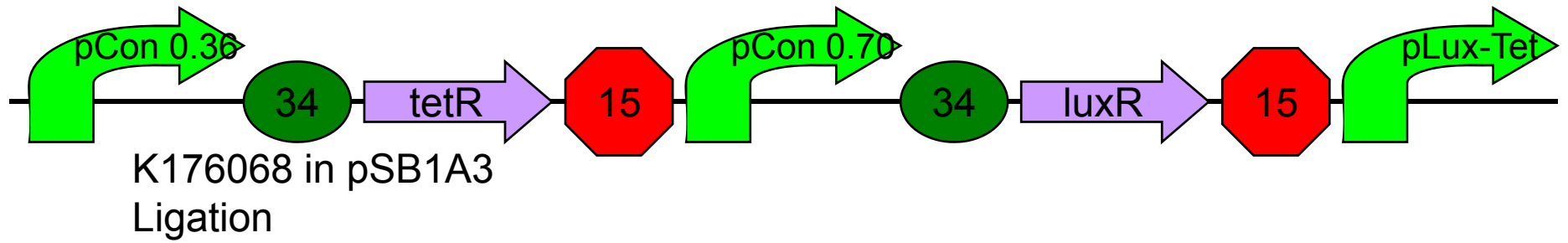

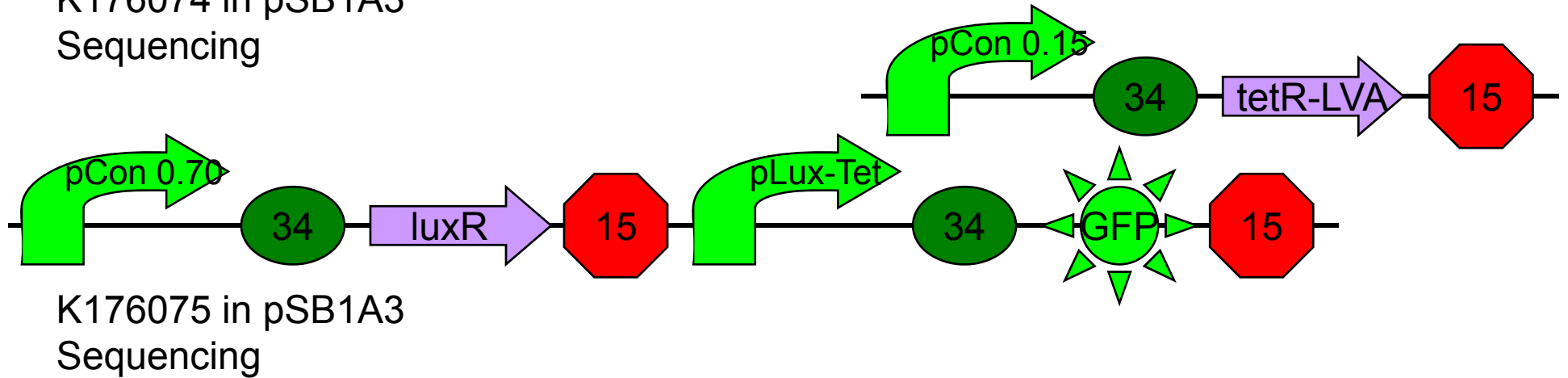
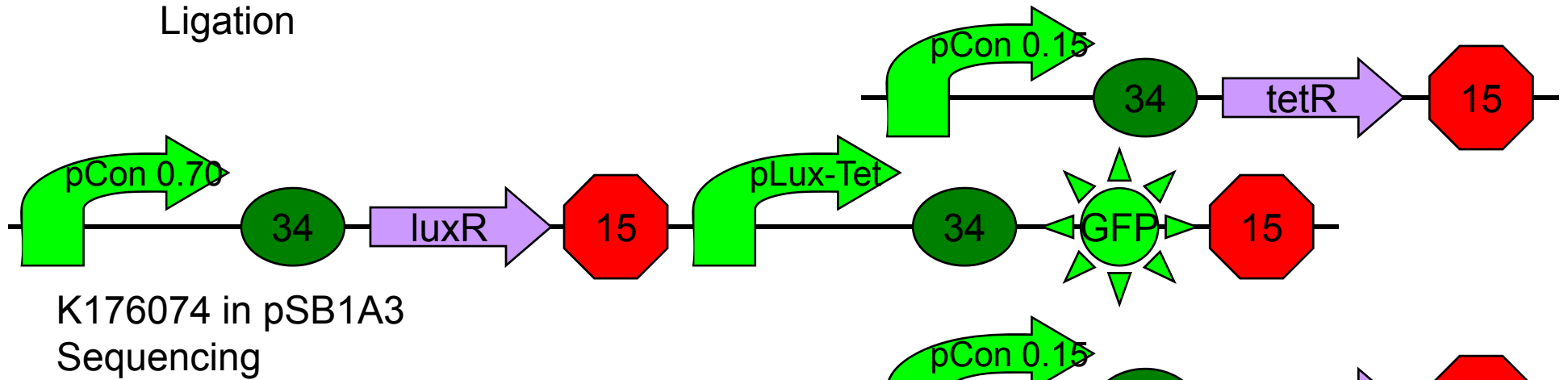
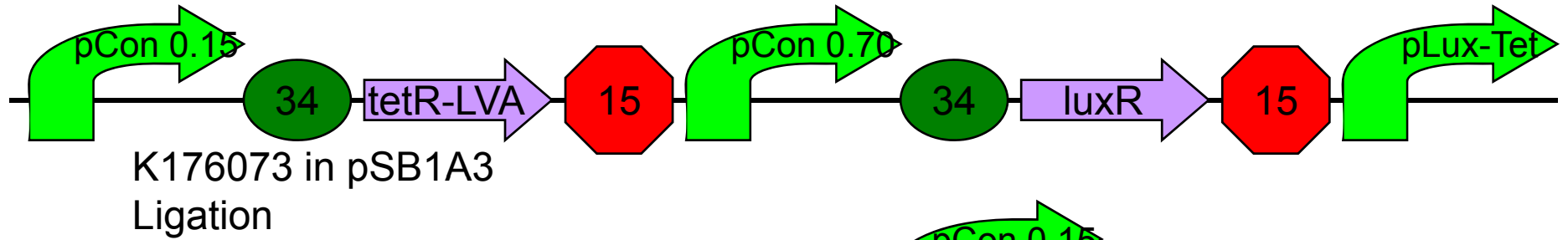
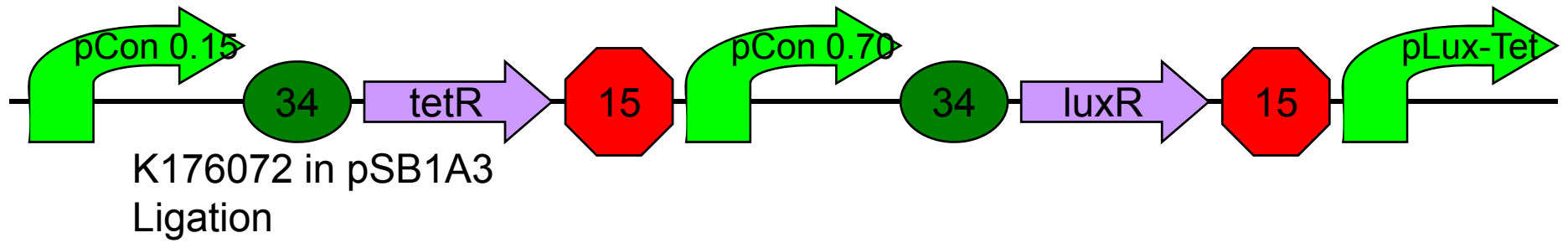

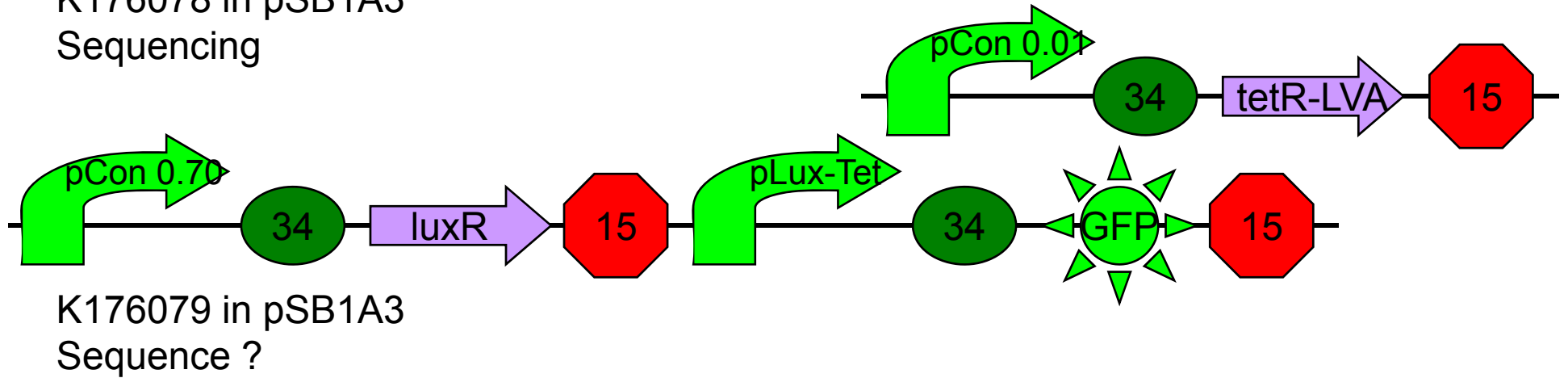
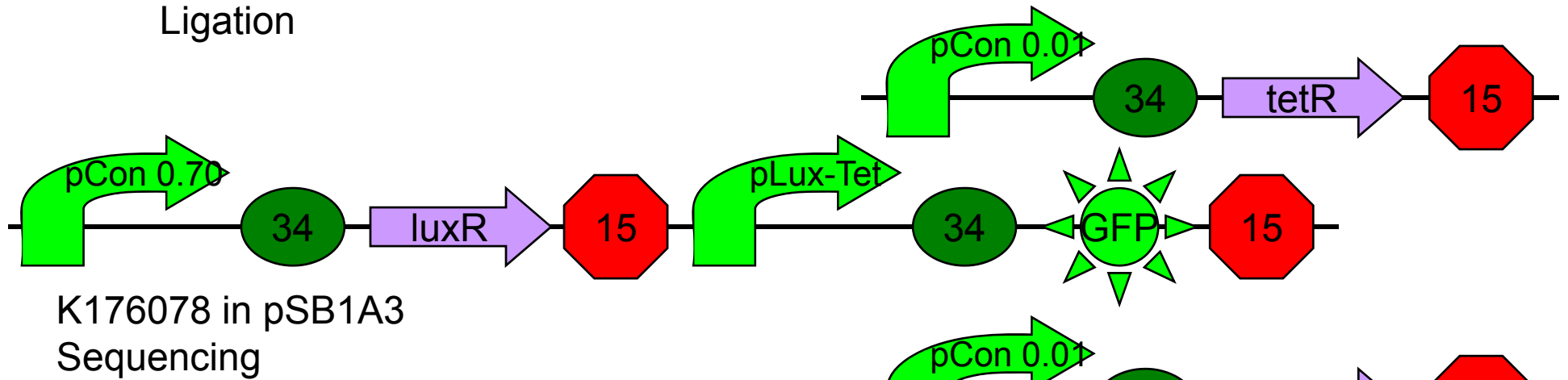
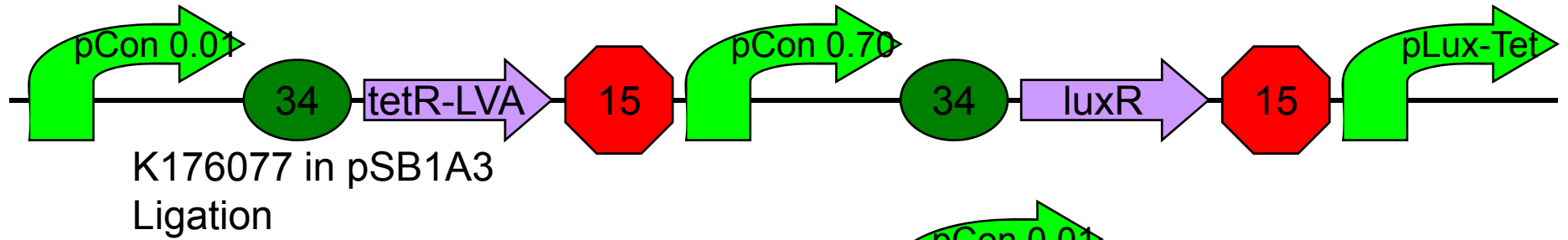
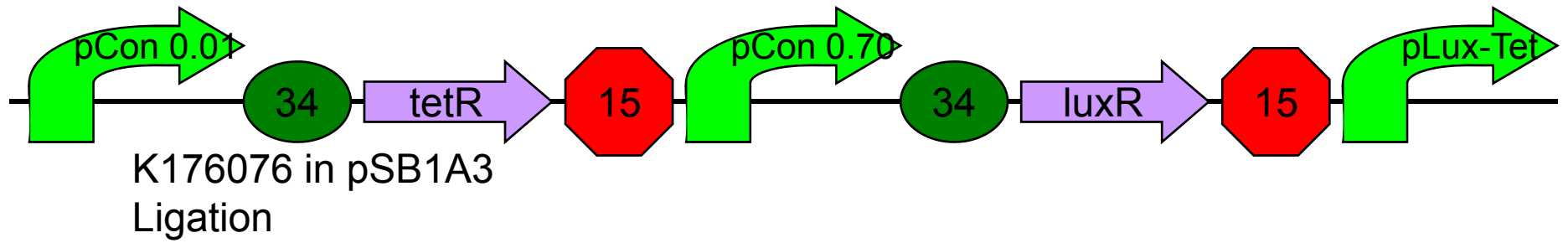



# K176067 (7+30)

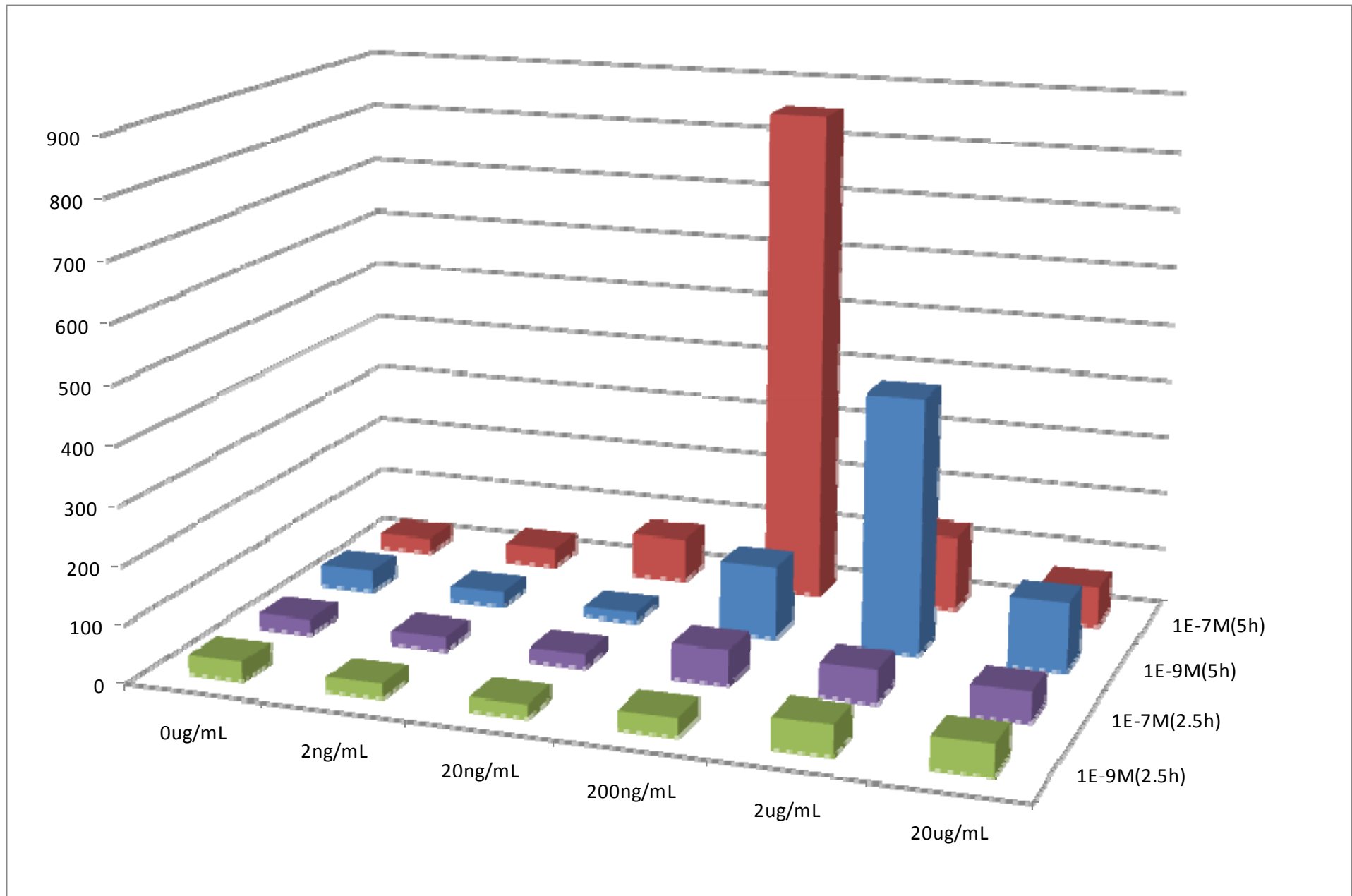

# K176070 (9+29)

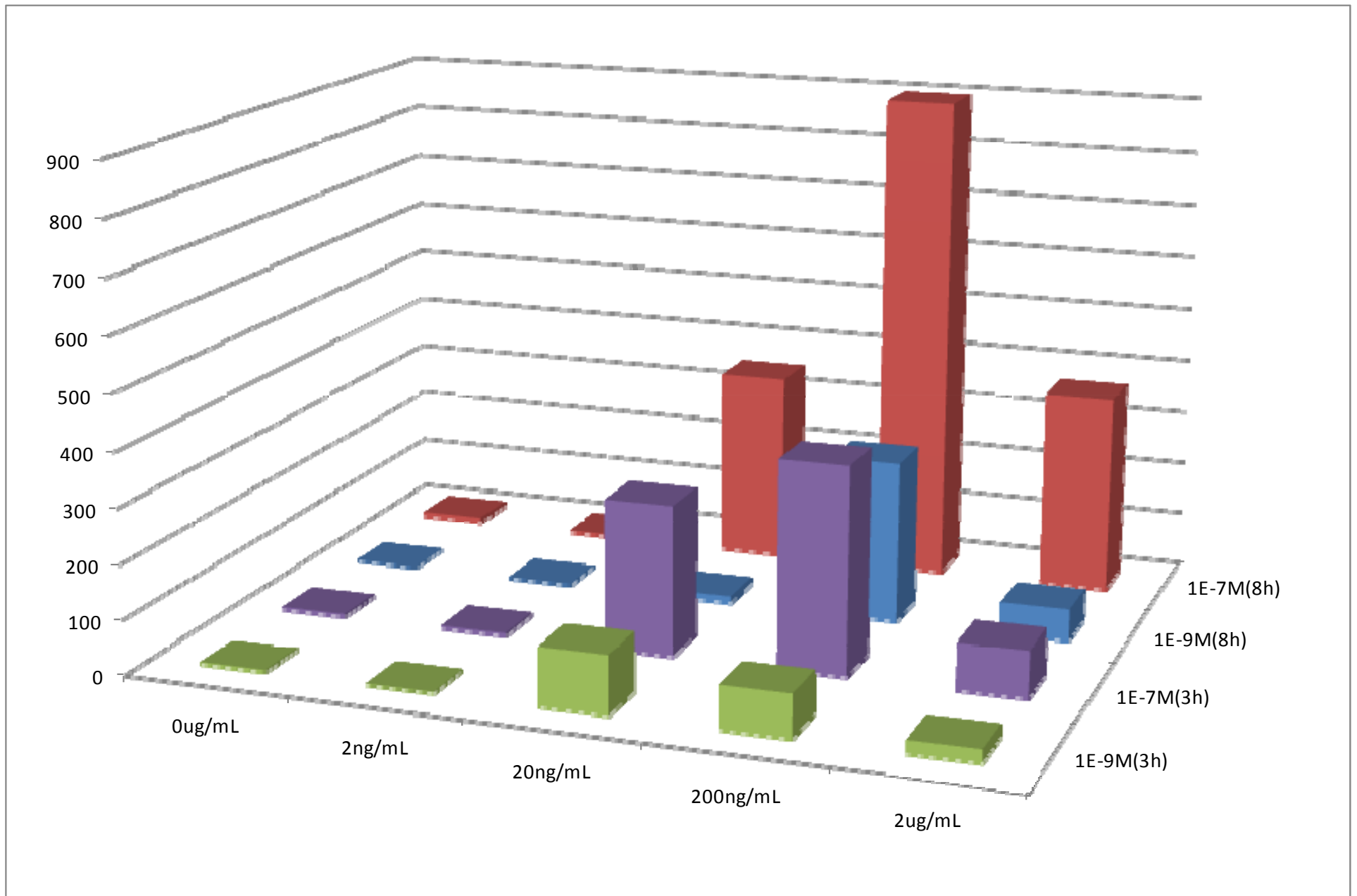



# K176071 (9+30)

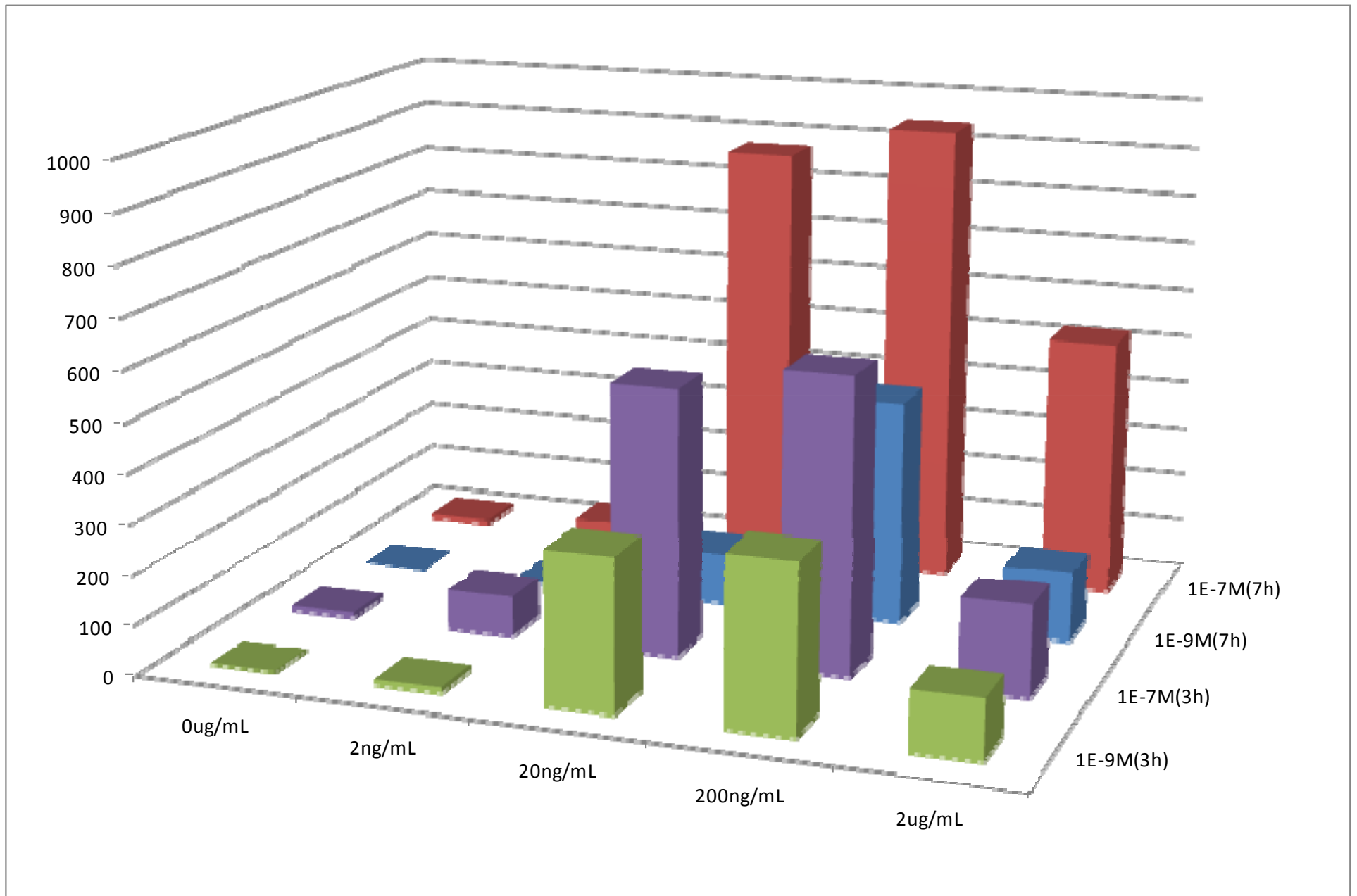

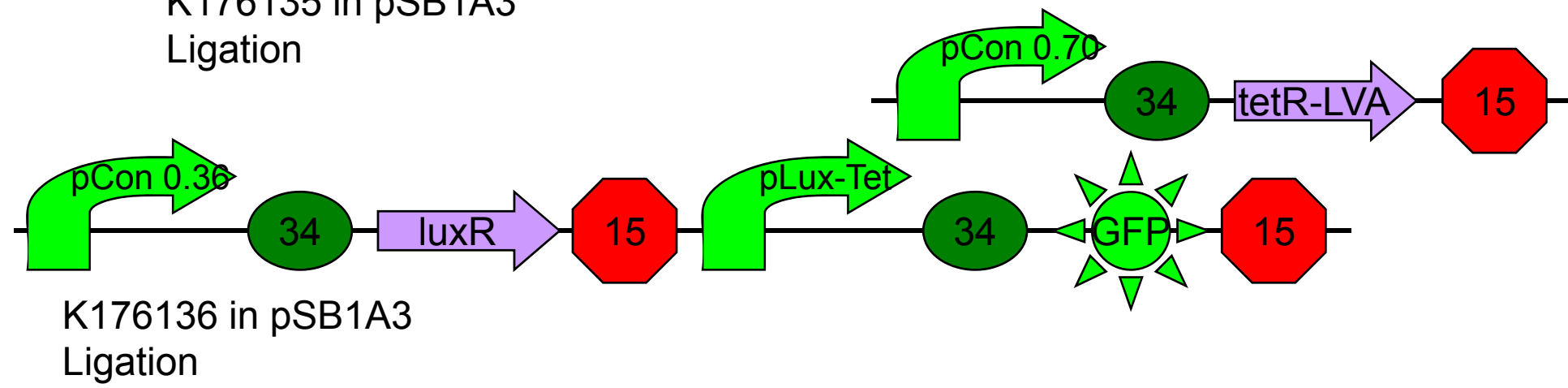
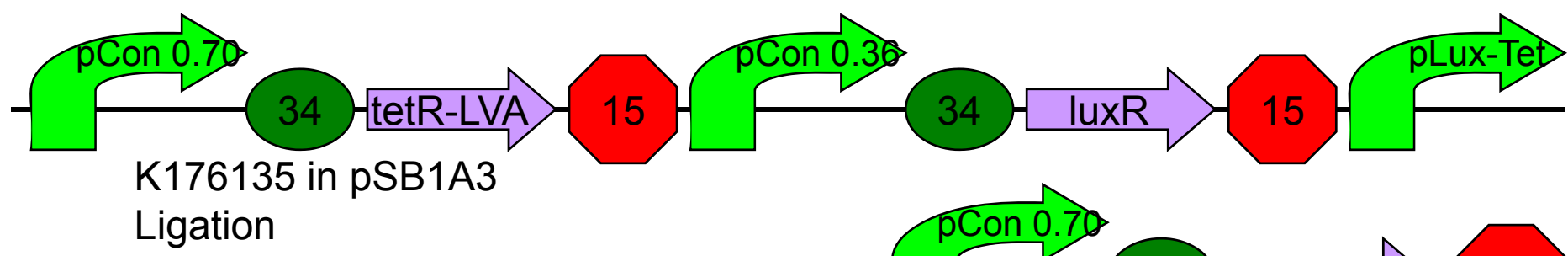
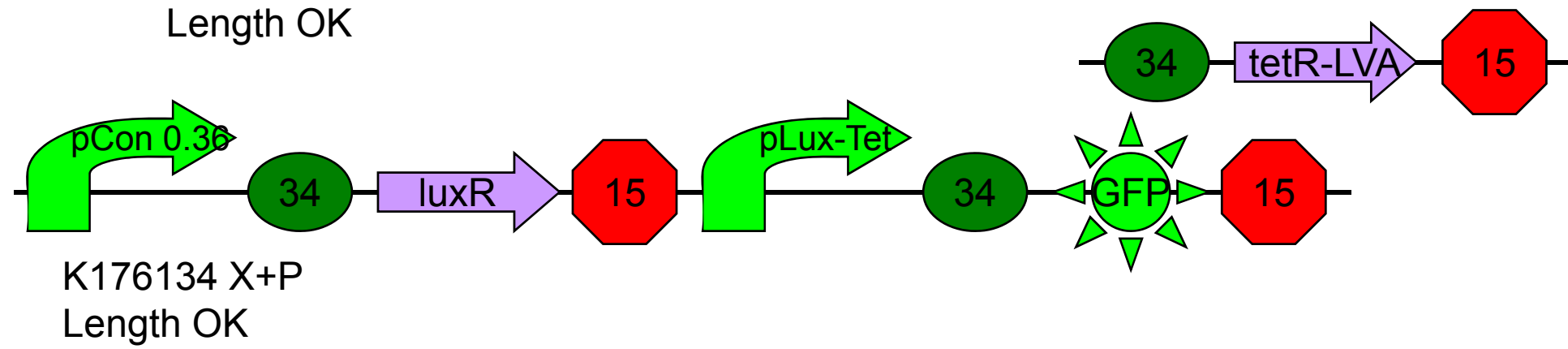
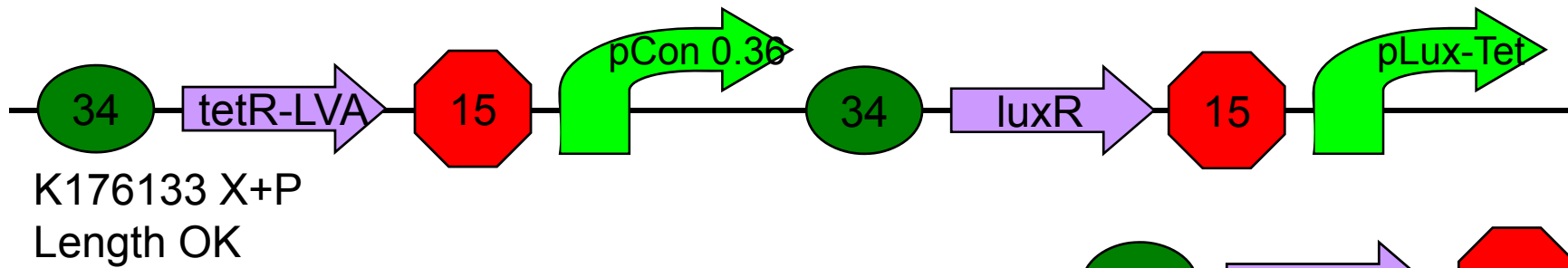

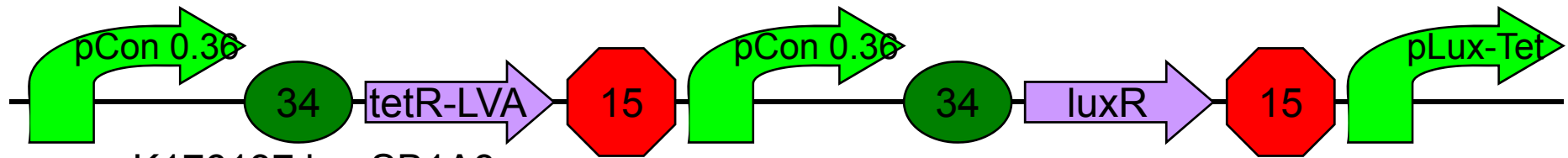

K176137 in pSB1A3  
Ligation

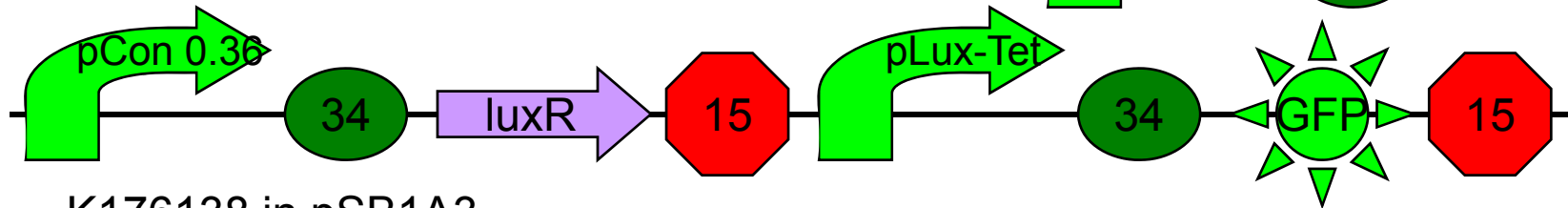
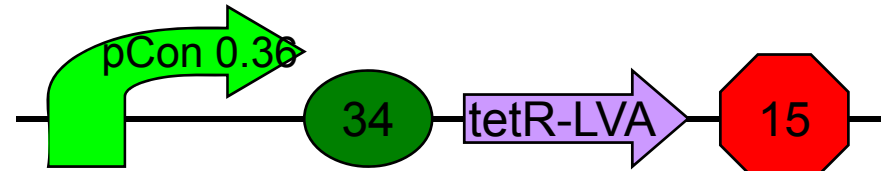

K176138 in pSB1A3  
Sequencing

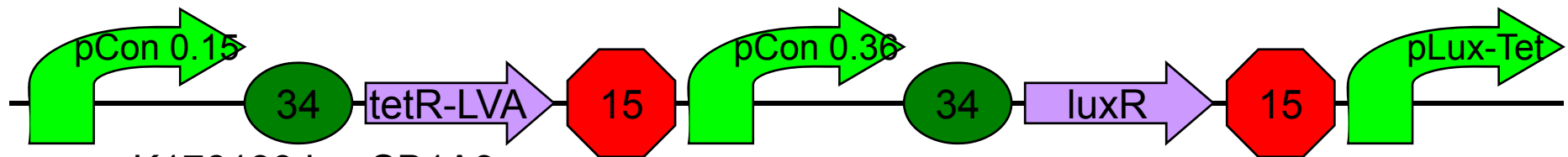

K176139 in pSB1A3  
Ligation

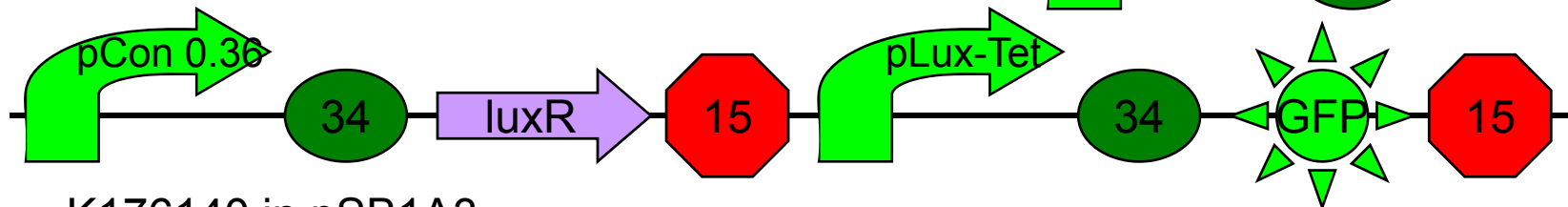
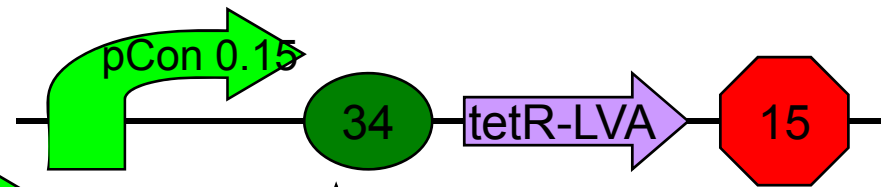

K176140 in pSB1A3  
Sequencing

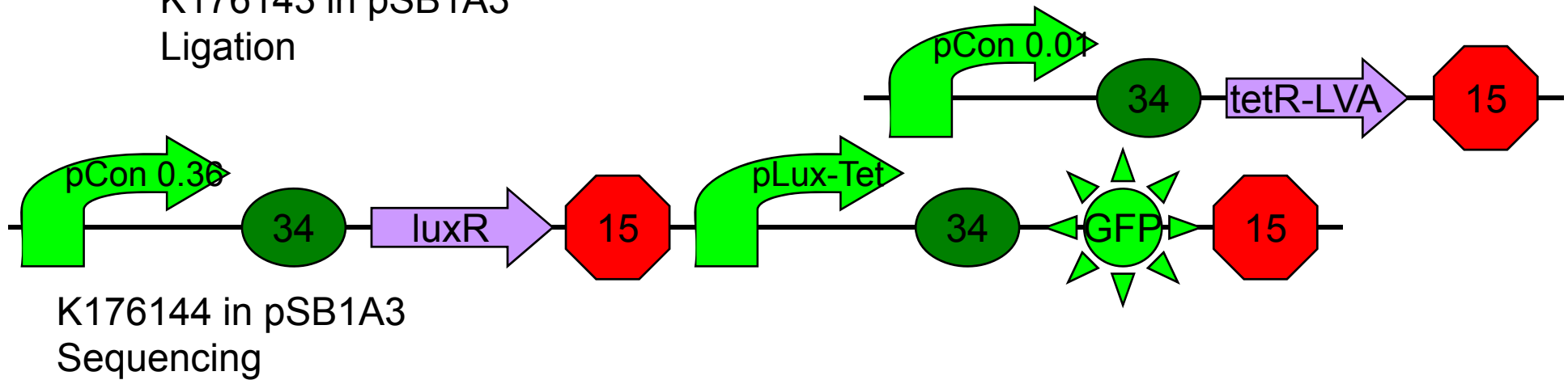
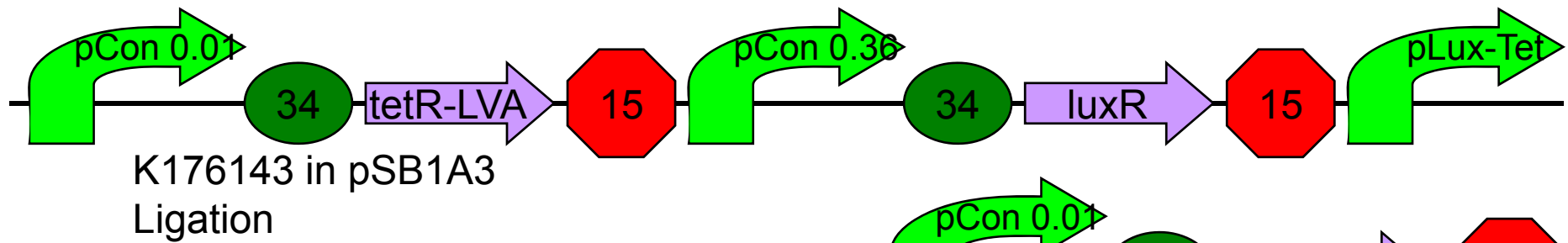
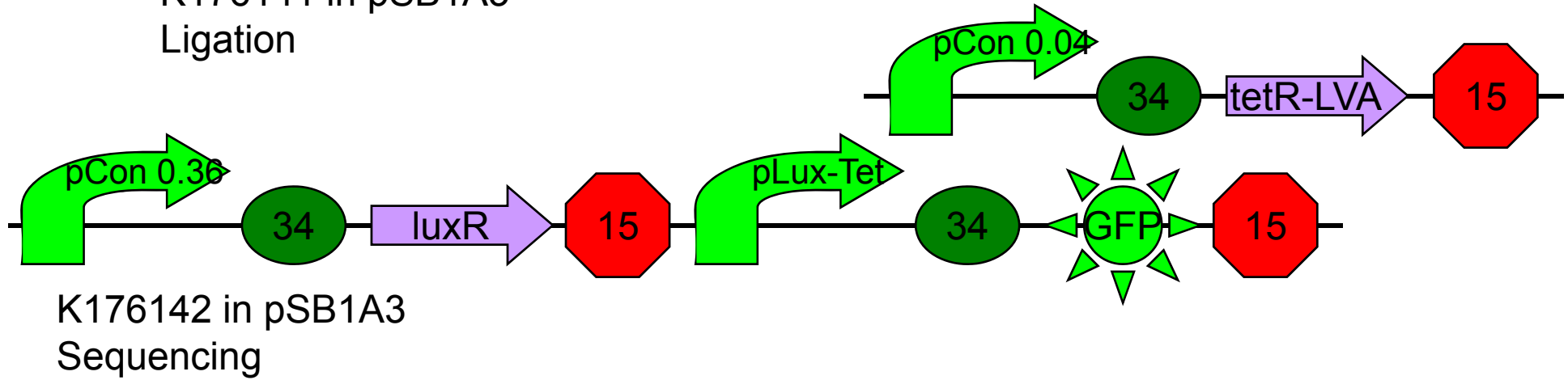
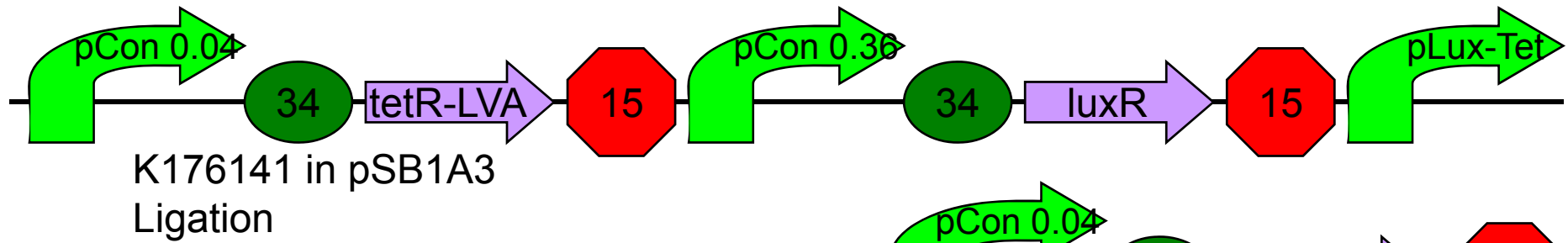

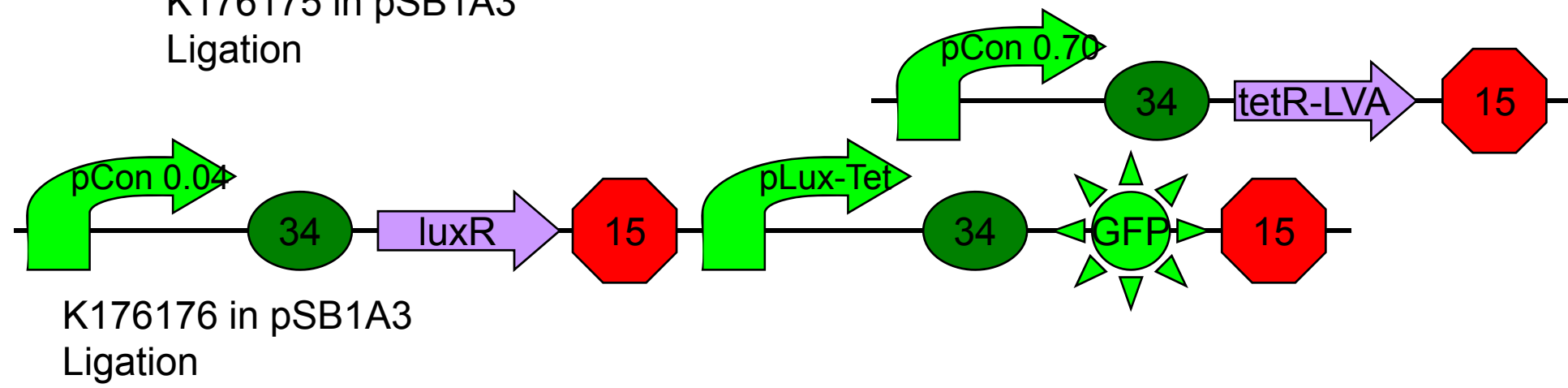
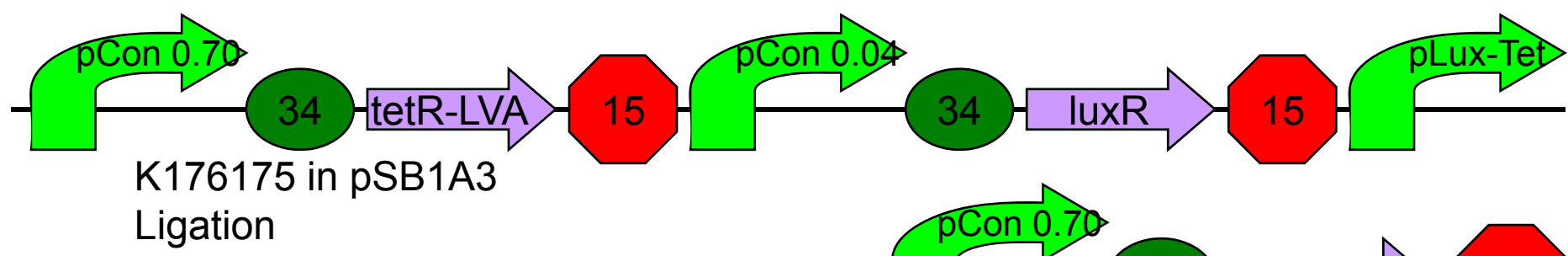
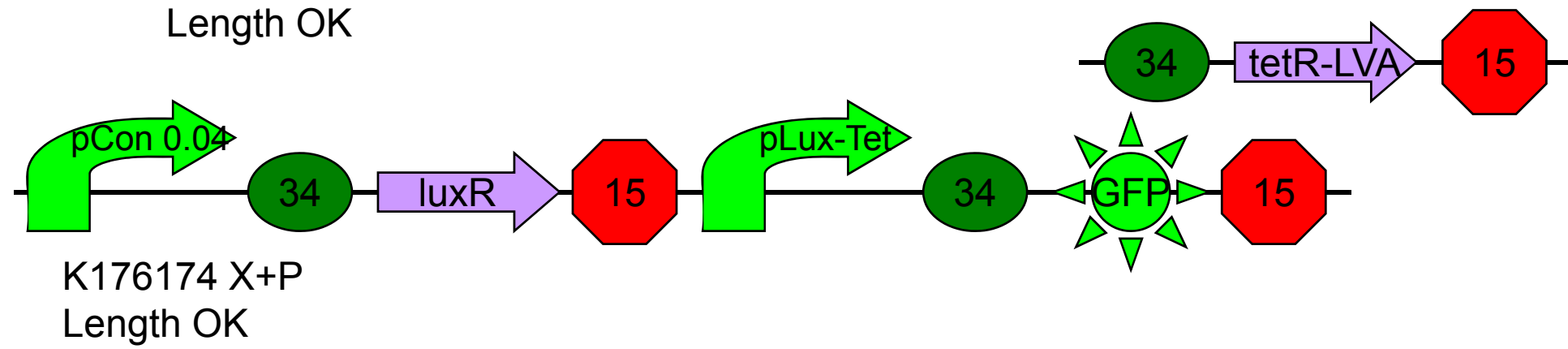
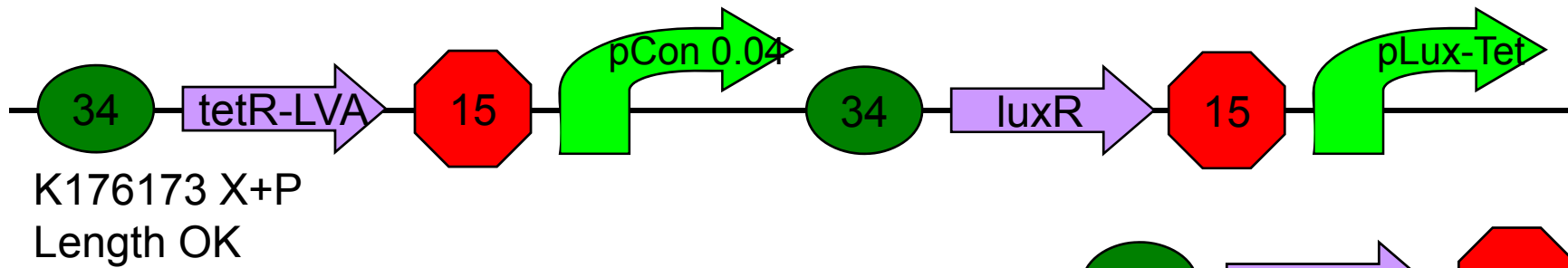

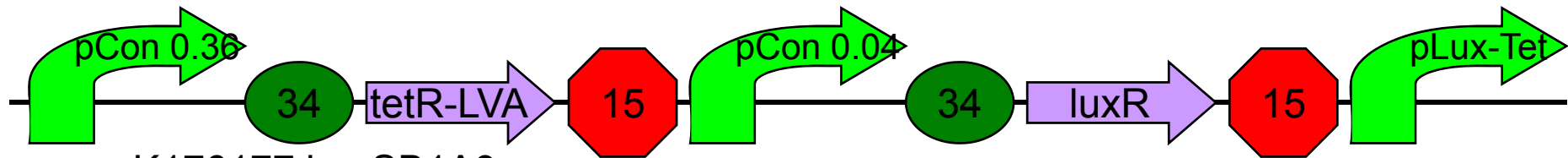

K176177 in pSB1A3  
Ligation

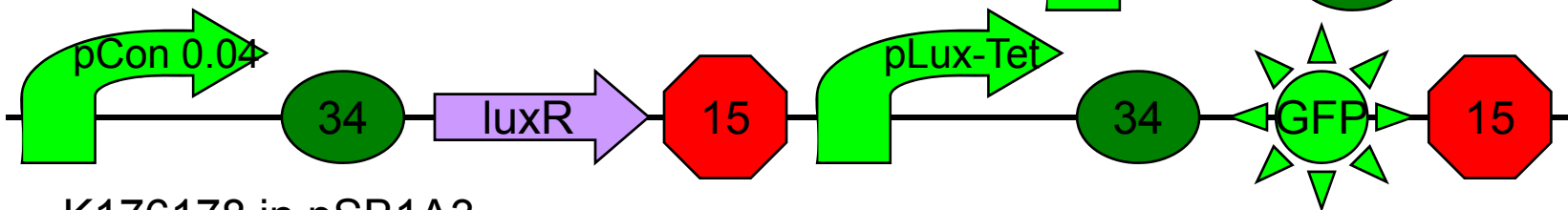
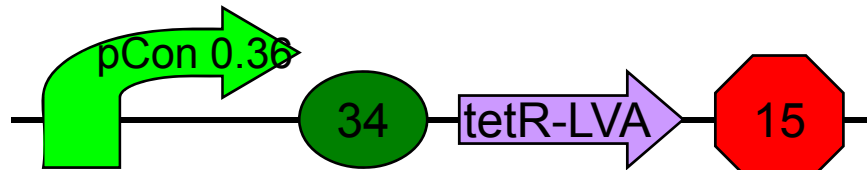

K176178 in pSB1A3  
Sequencing

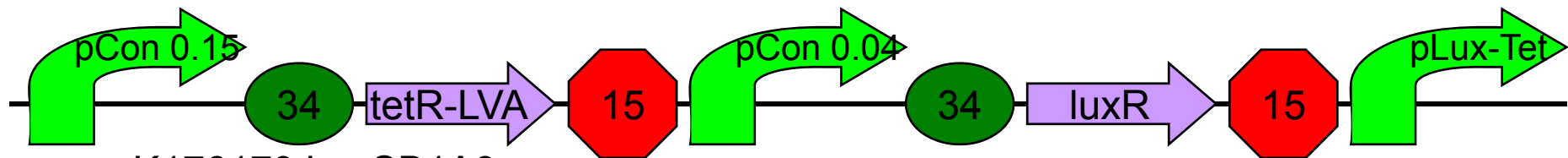

K176179 in pSB1A3  
Ligation

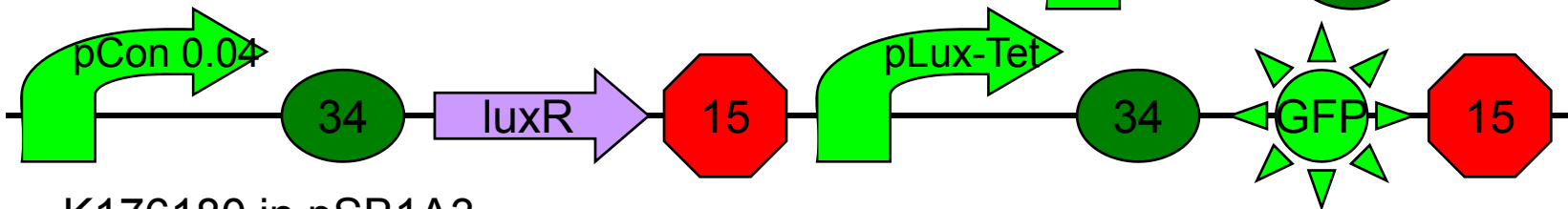
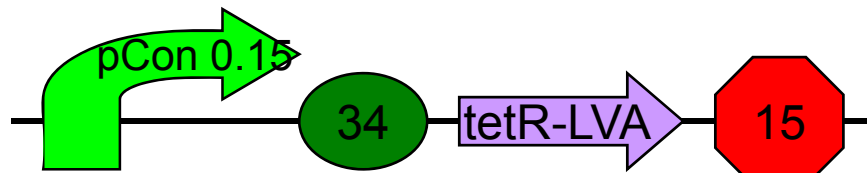

K176180 in pSB1A3  
Sequencing

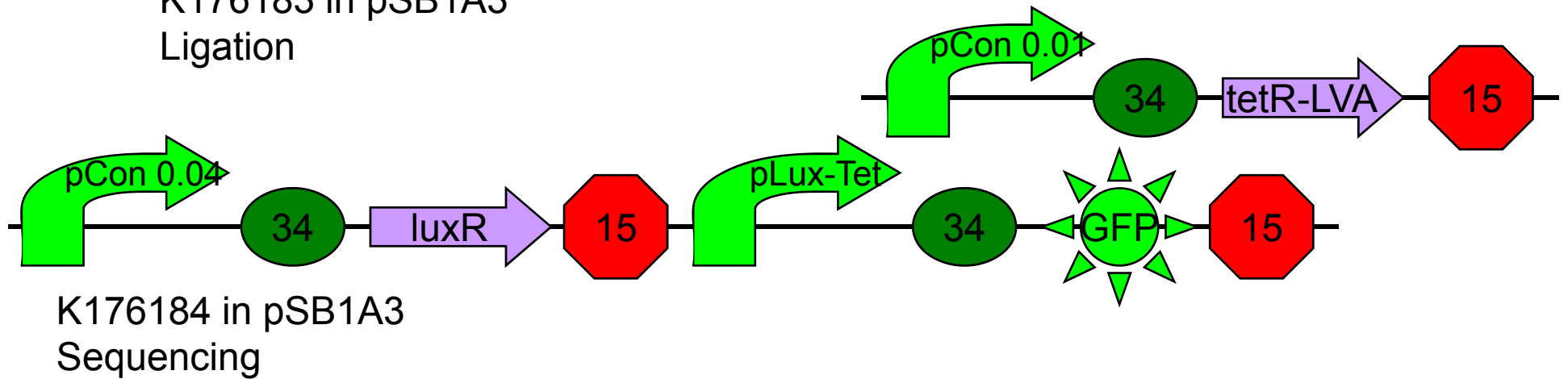
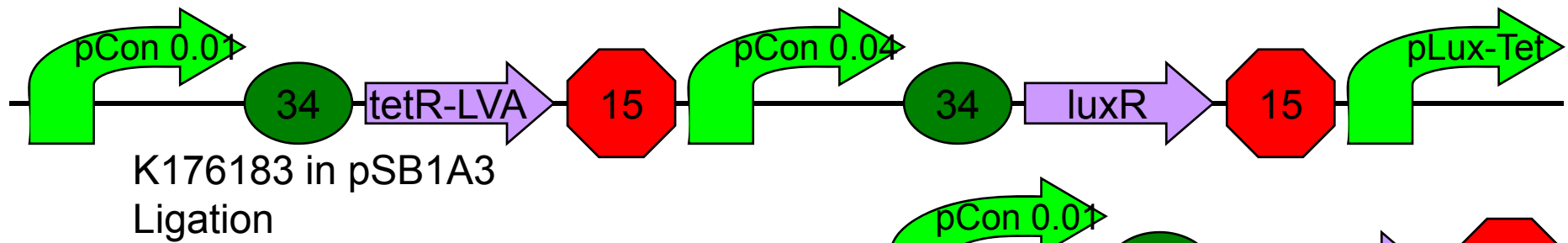
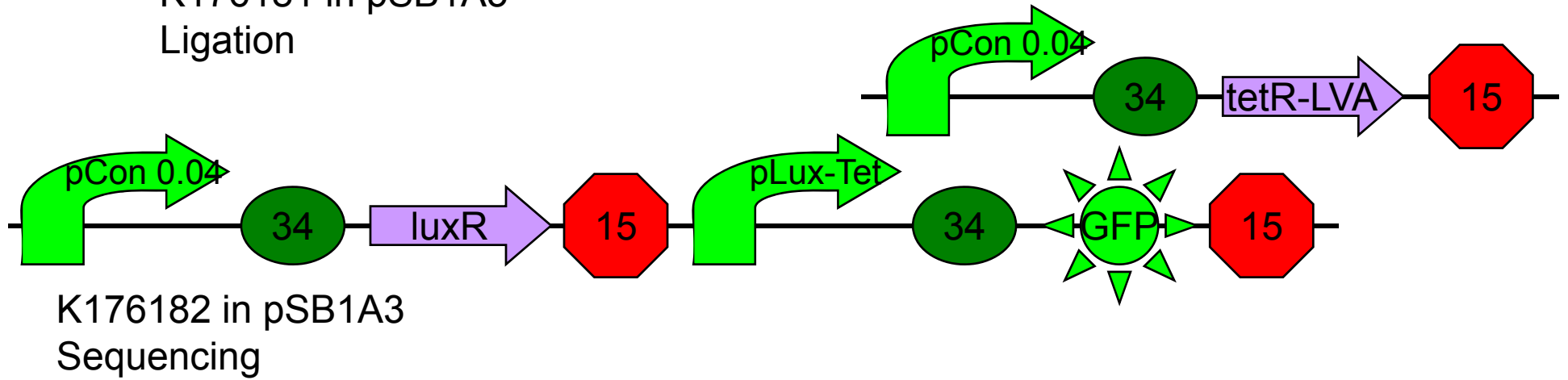
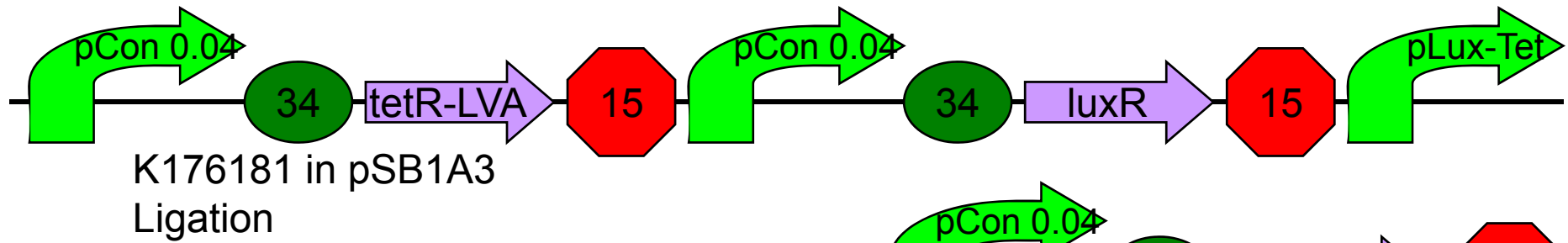

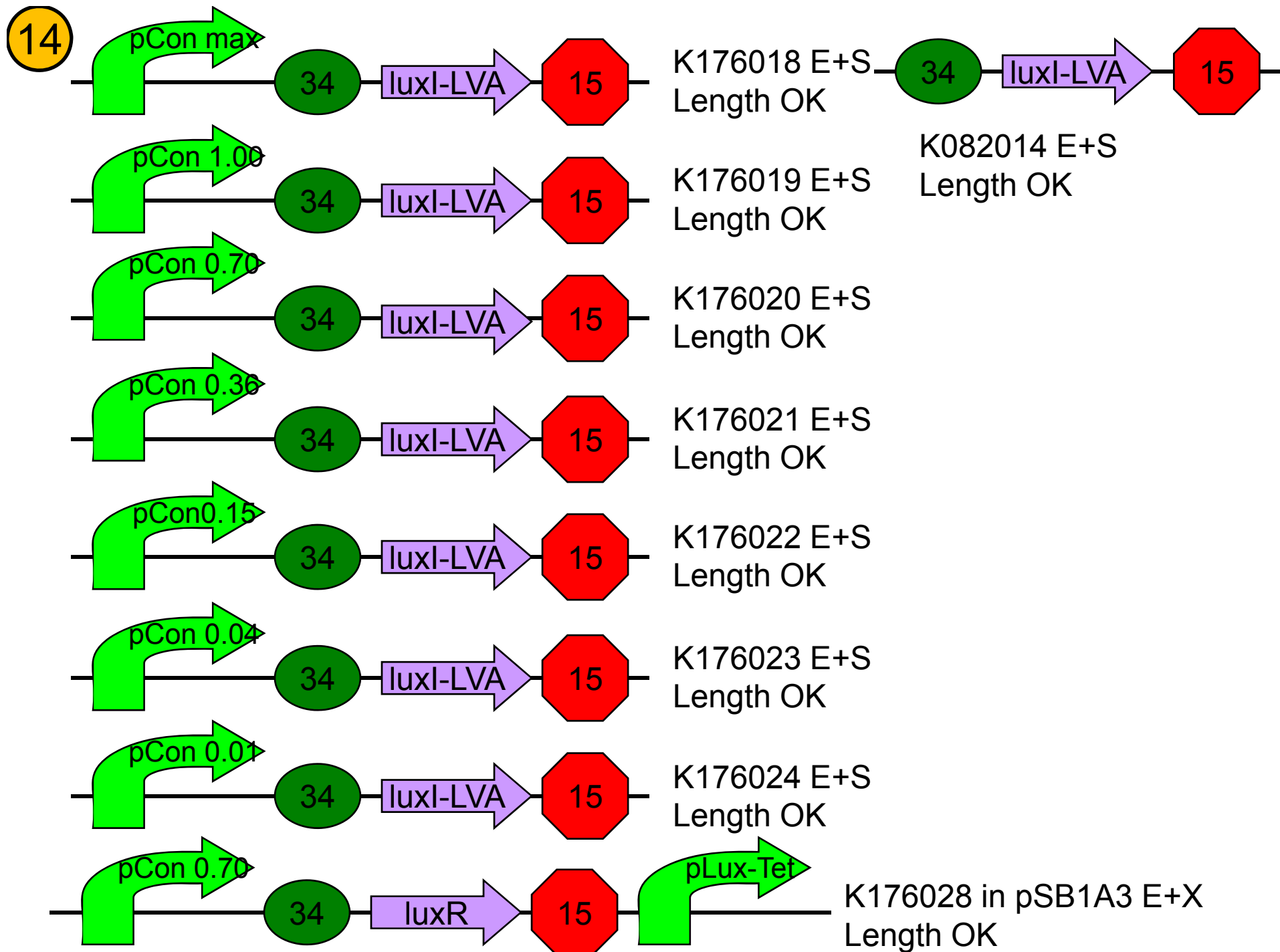



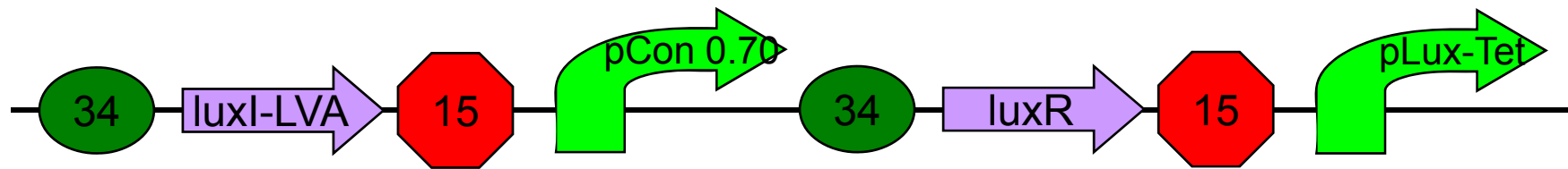

K176080 in pSB1A3  
Liagtion

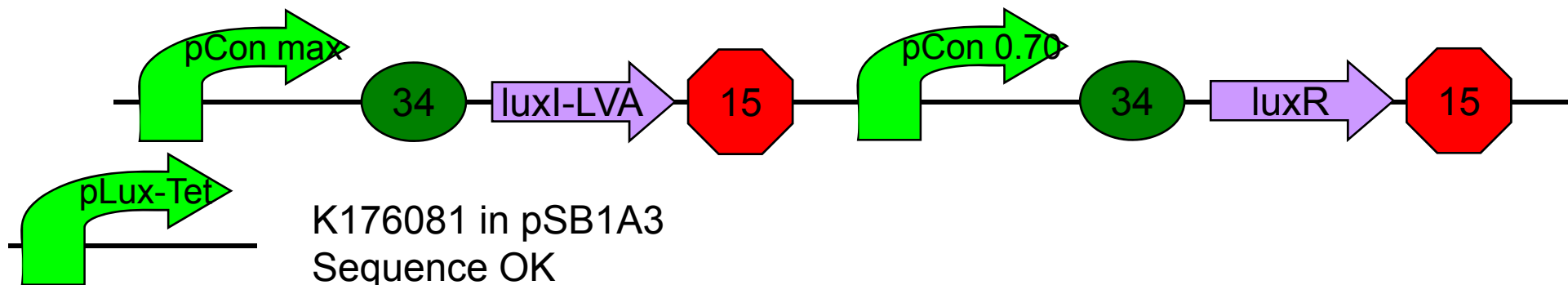

K176081 in pSB1A3  
Sequence OK

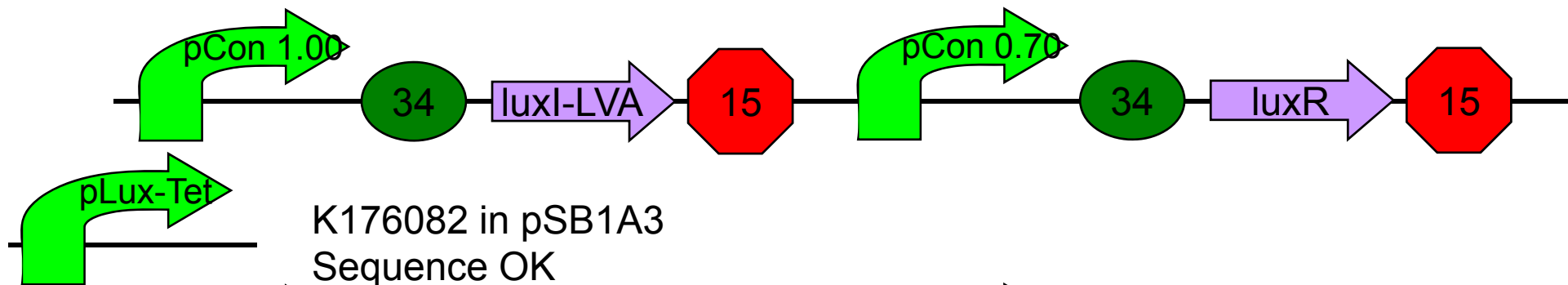

K176082 in pSB1A3  
Sequence OK

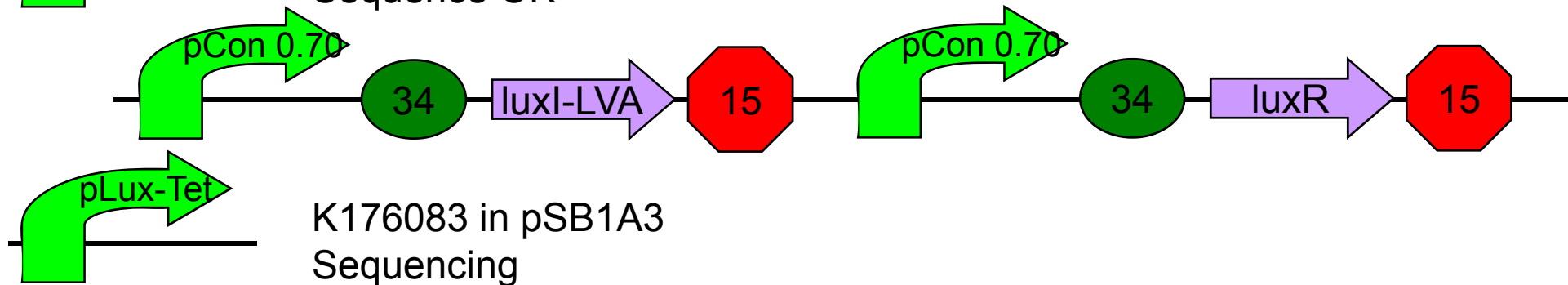

K176083 in pSB1A3  
Sequencing

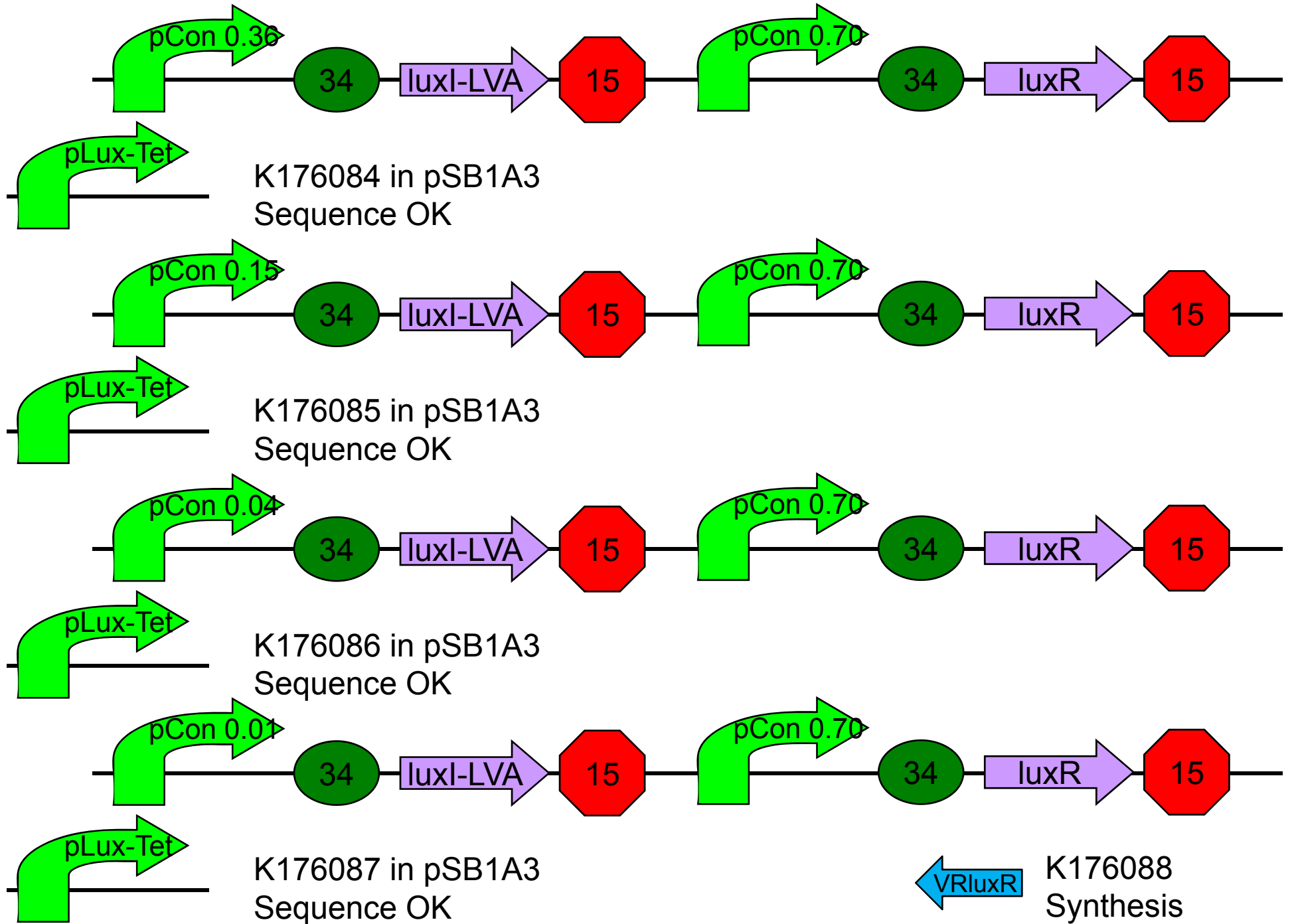

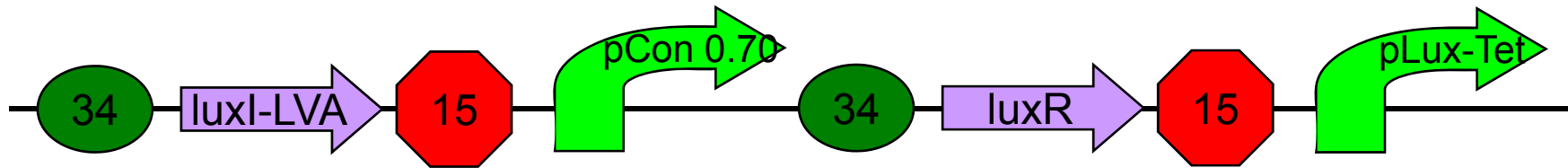

K176080 in pSB1A3 S+P  
Waiting

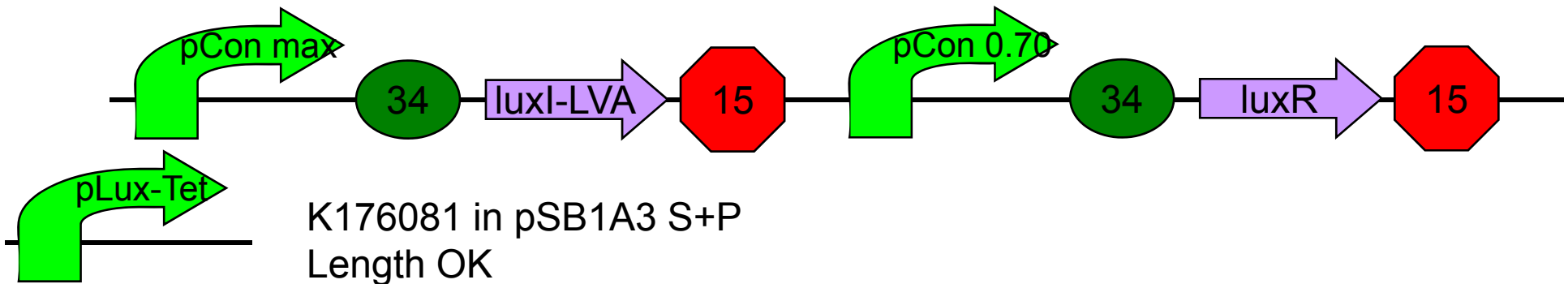

K176081 in pSB1A3 S+P  
Length OK

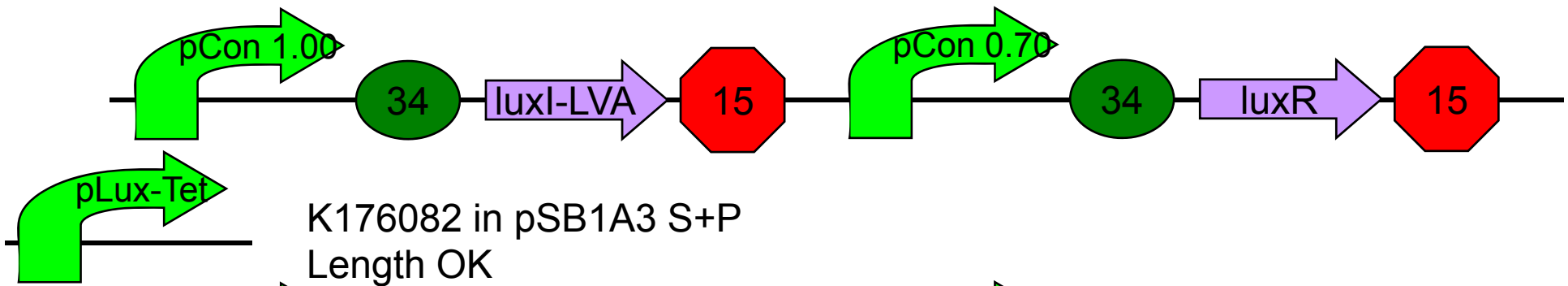

K176082 in pSB1A3 S+P  
Length OK

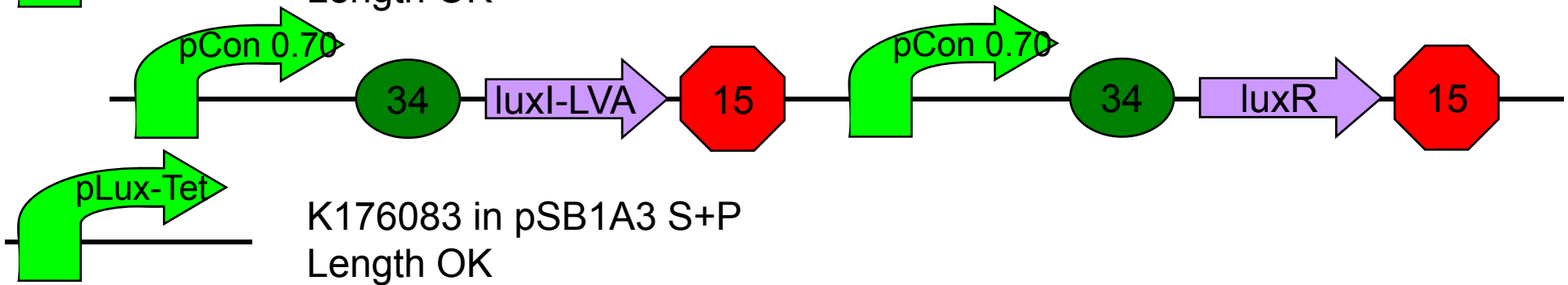

K176083 in pSB1A3 S+P  
Length OK

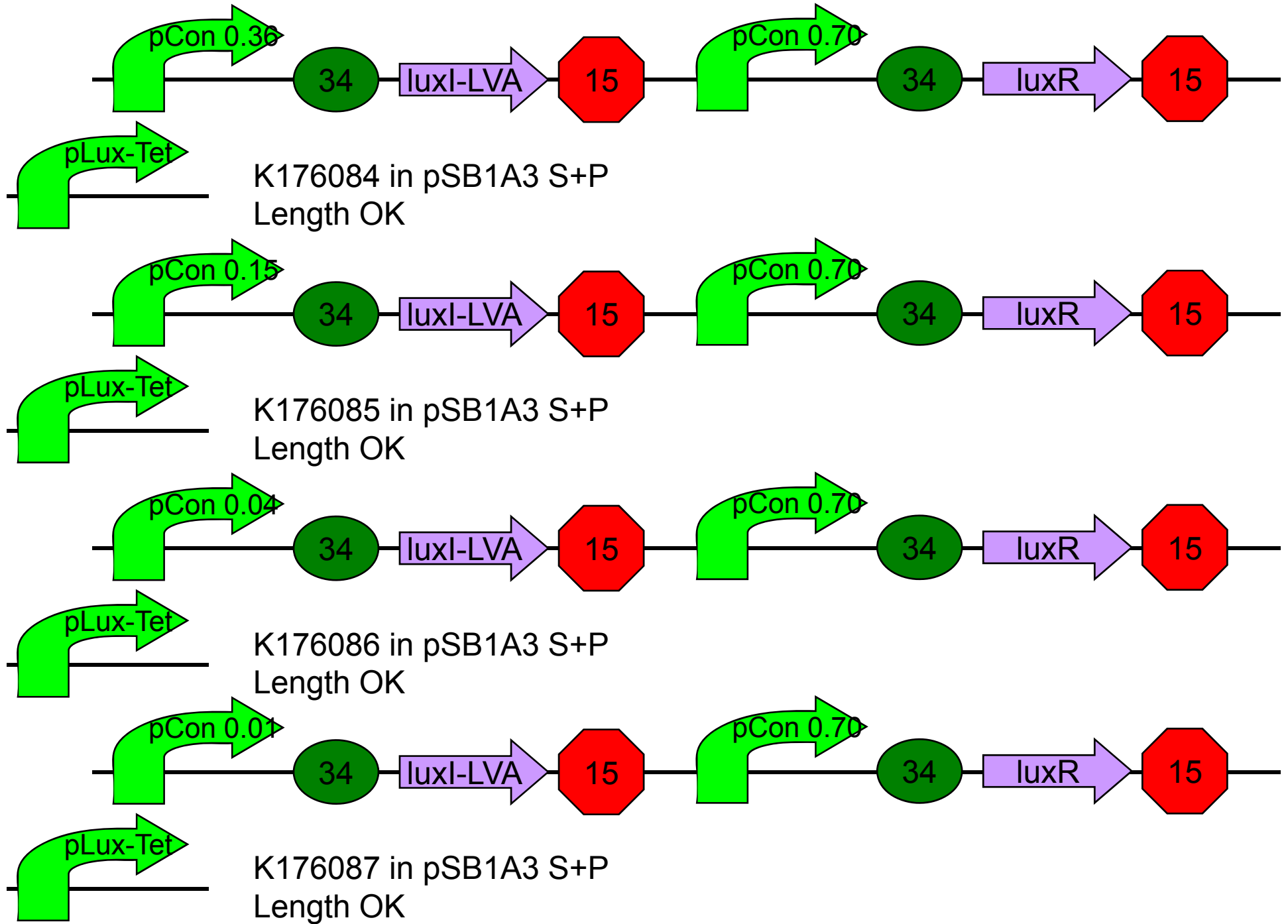

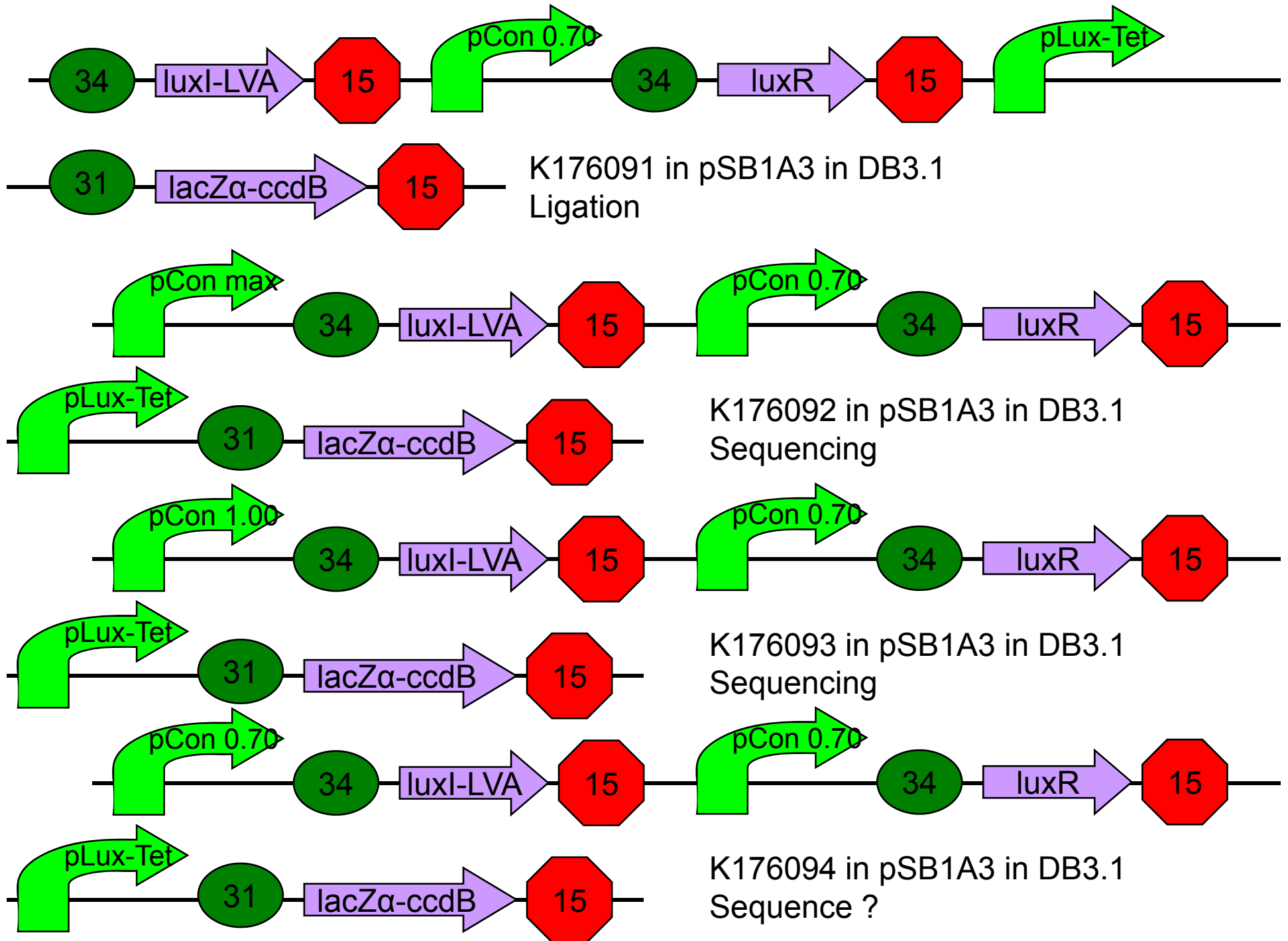

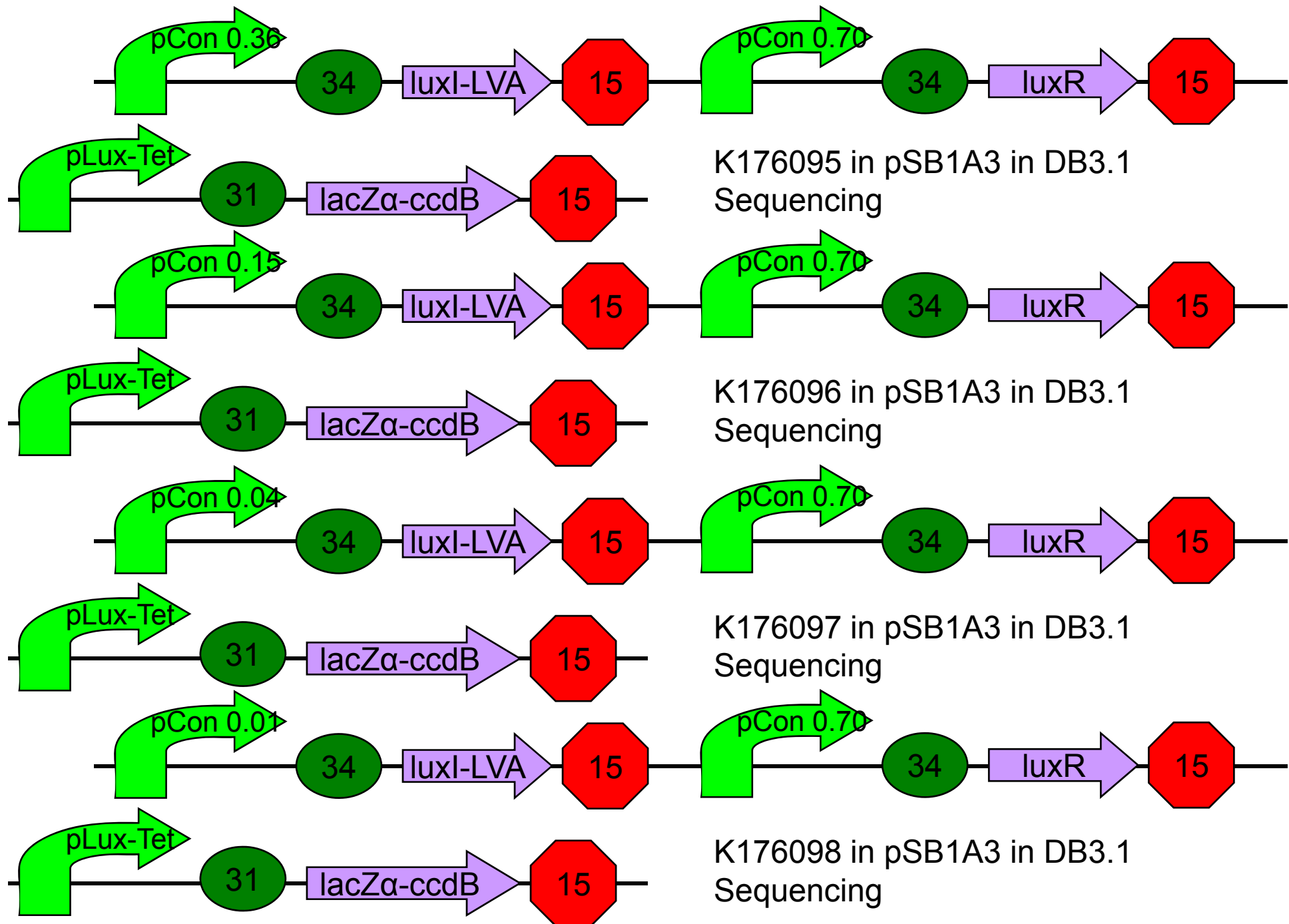

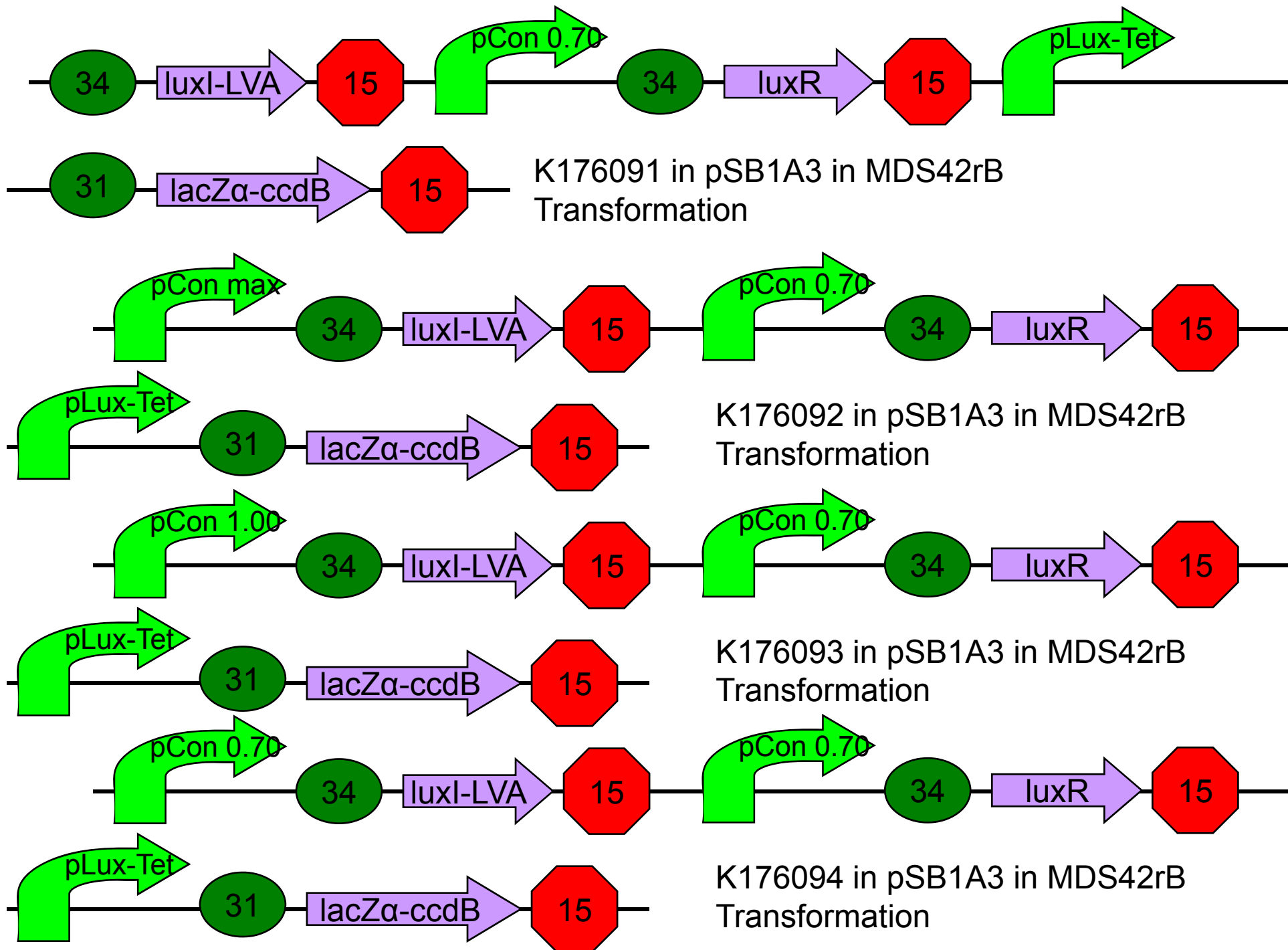

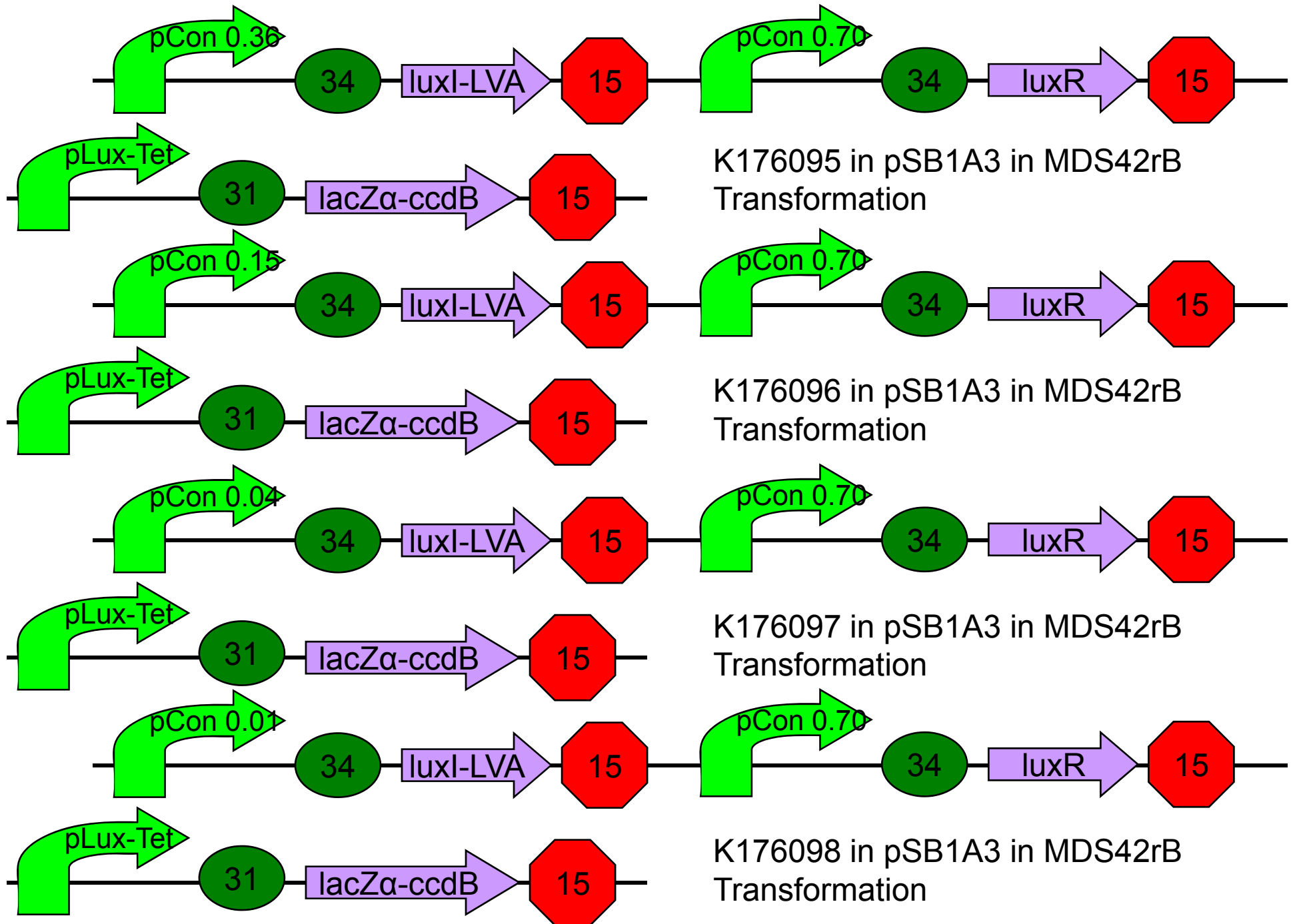



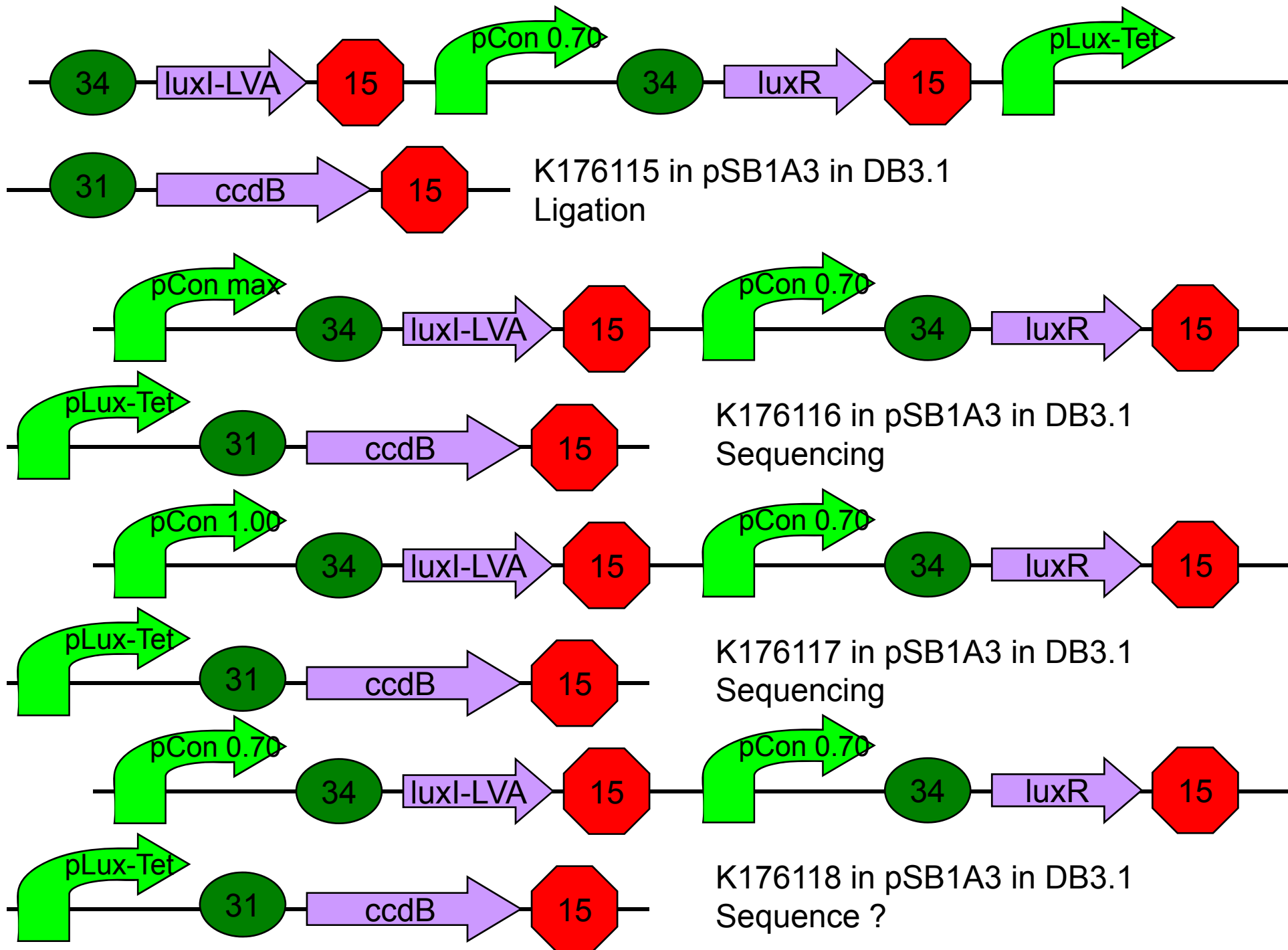

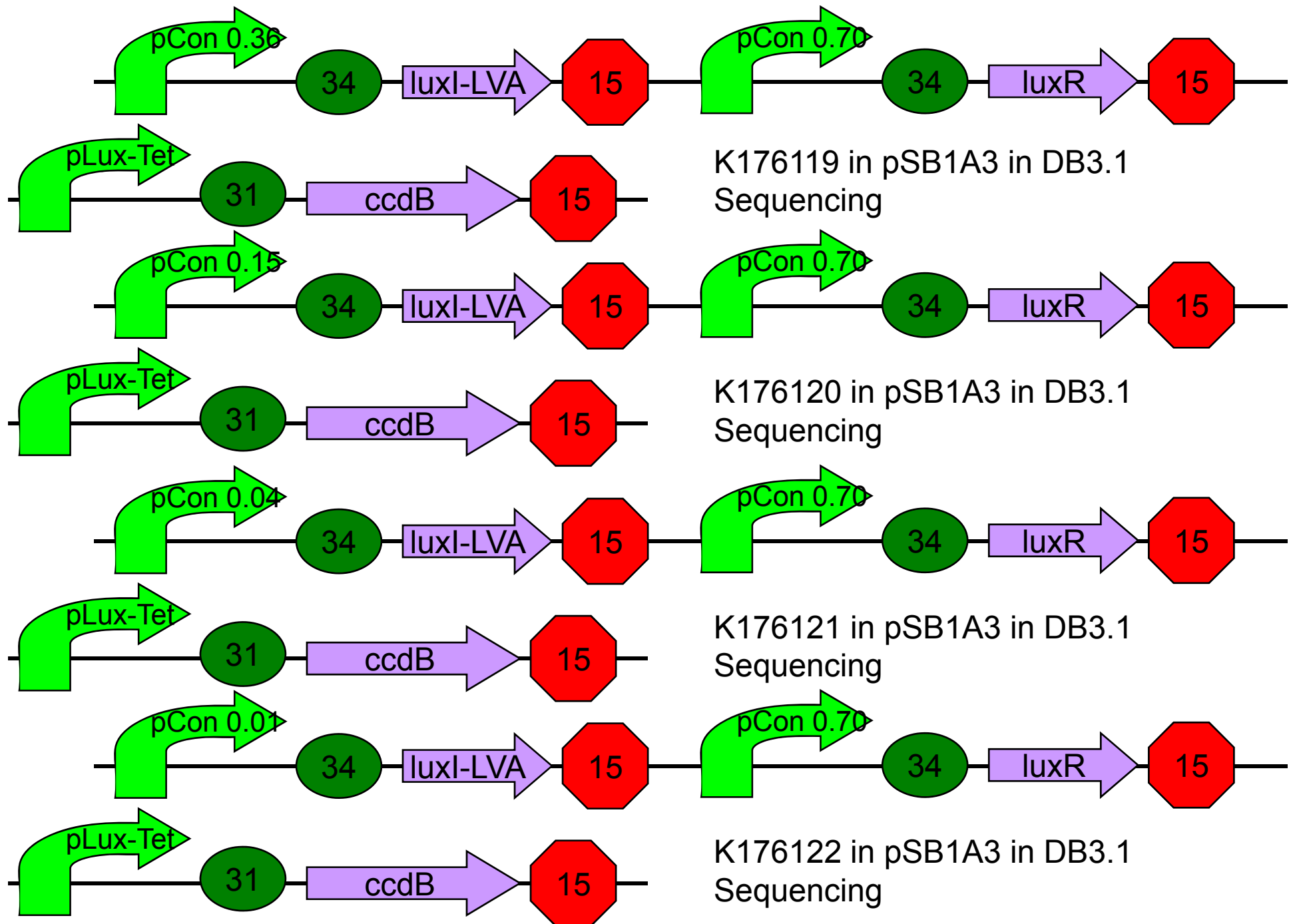

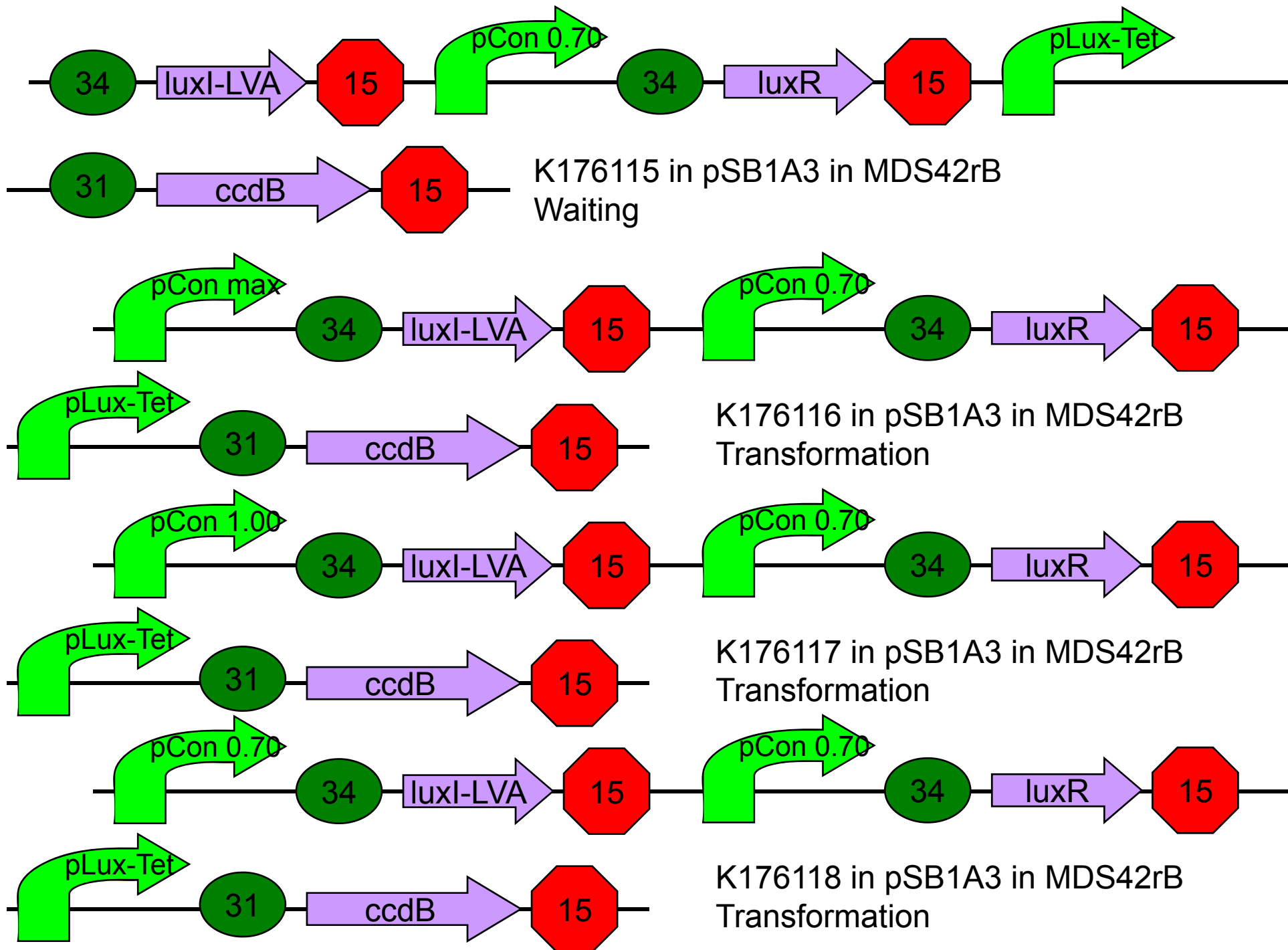

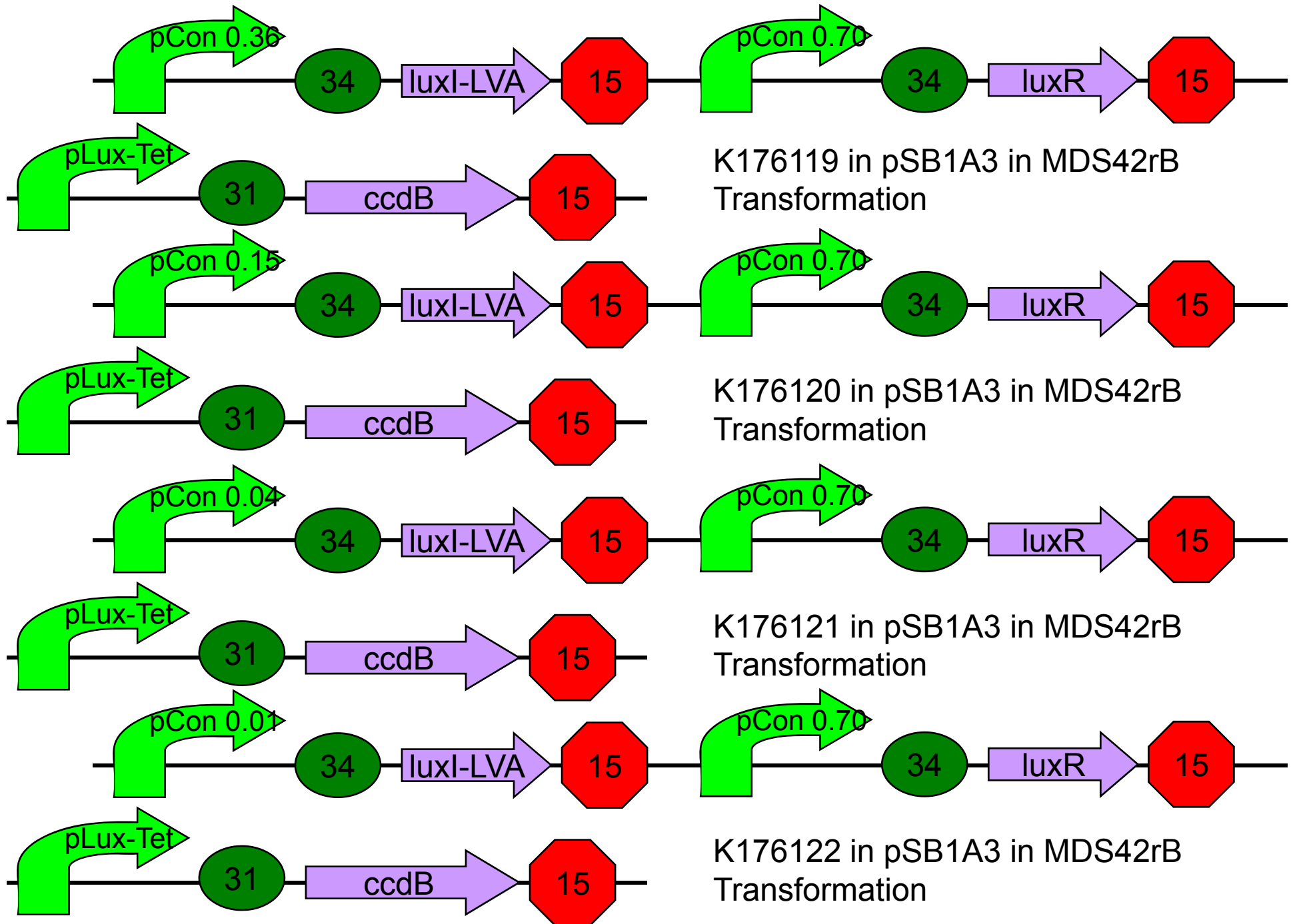

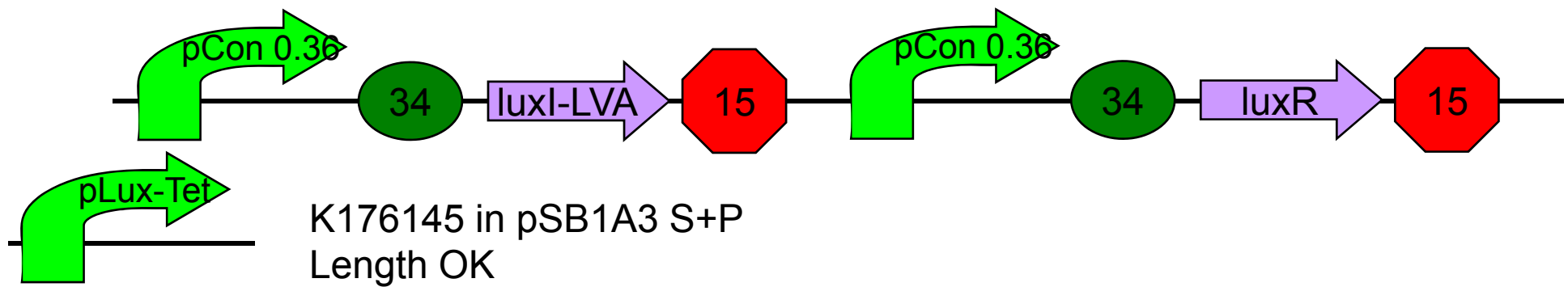
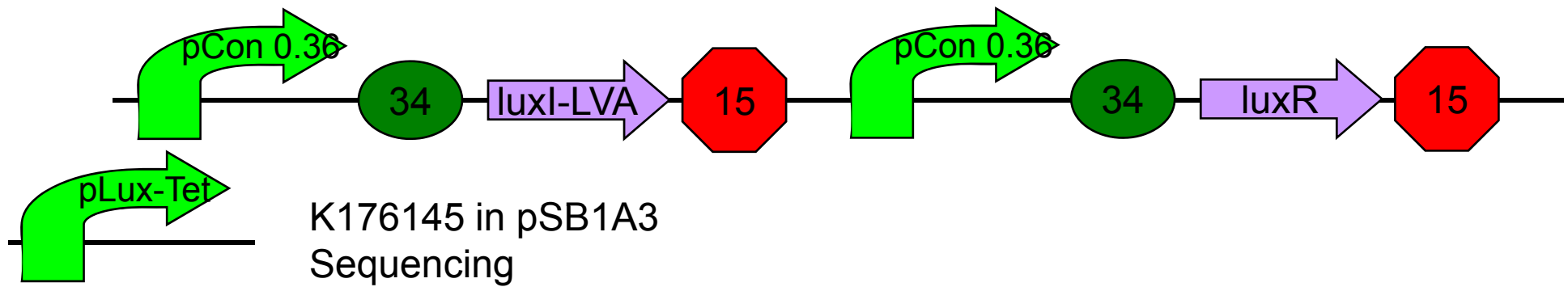
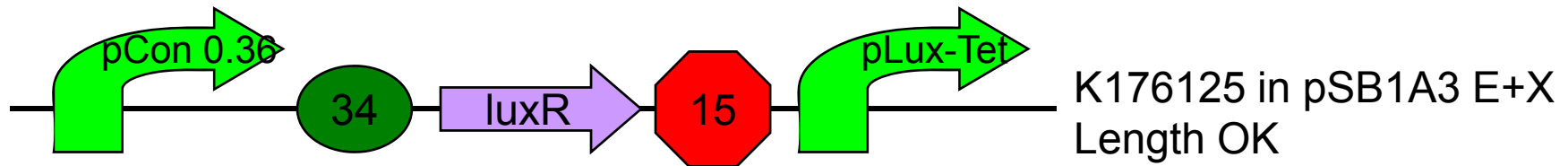

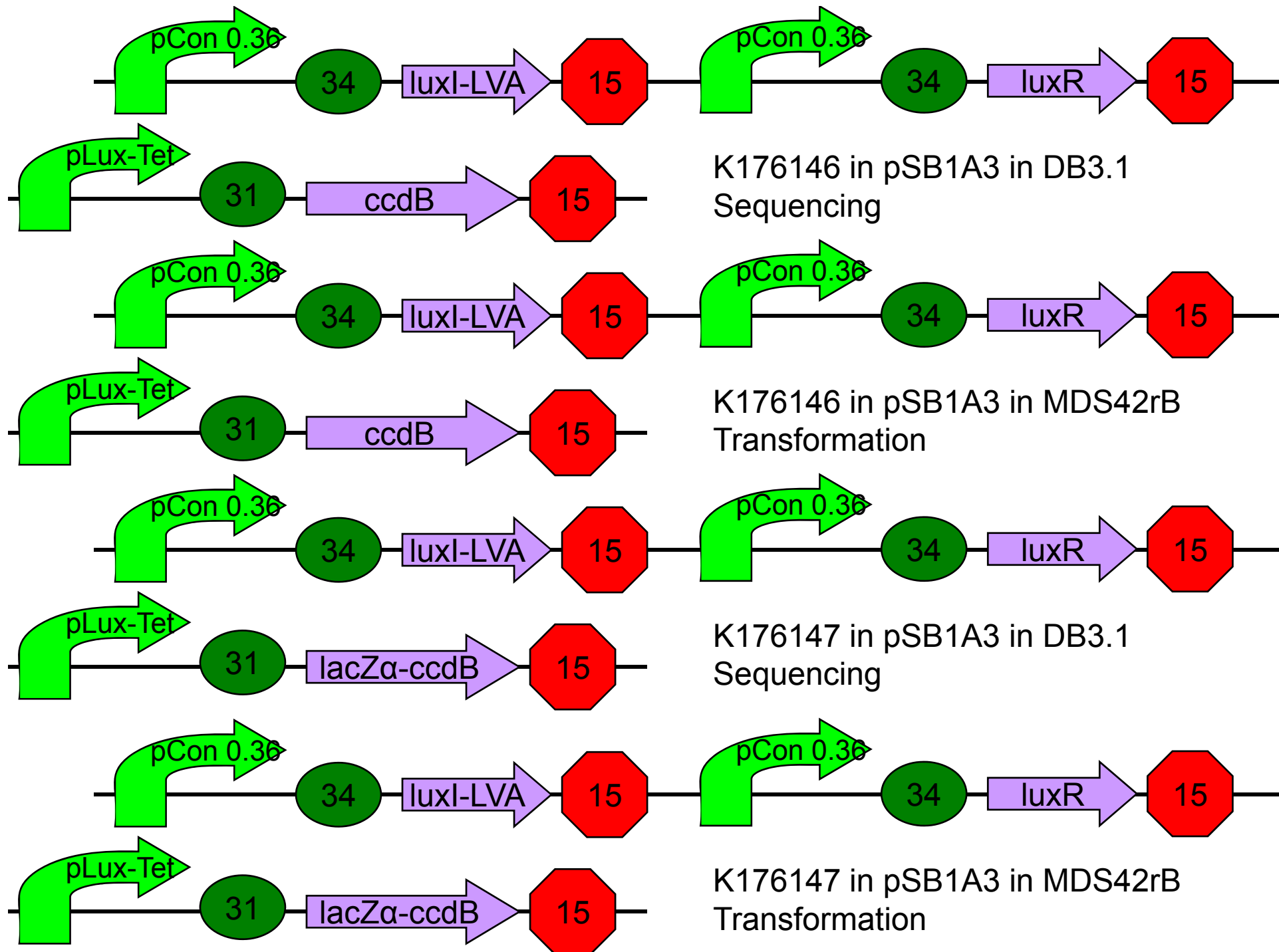

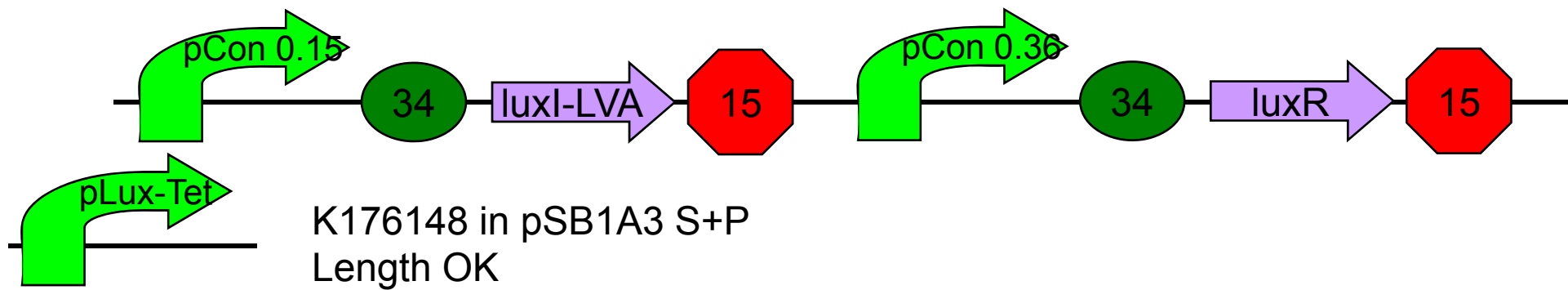
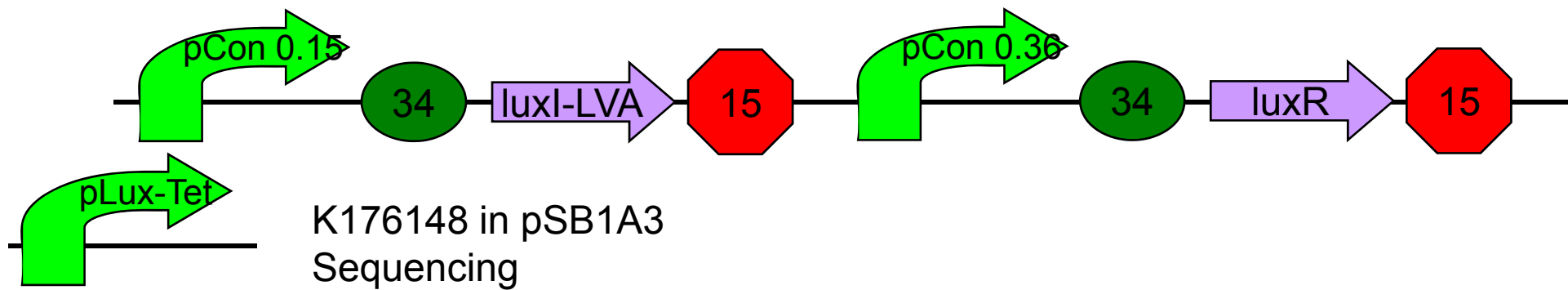

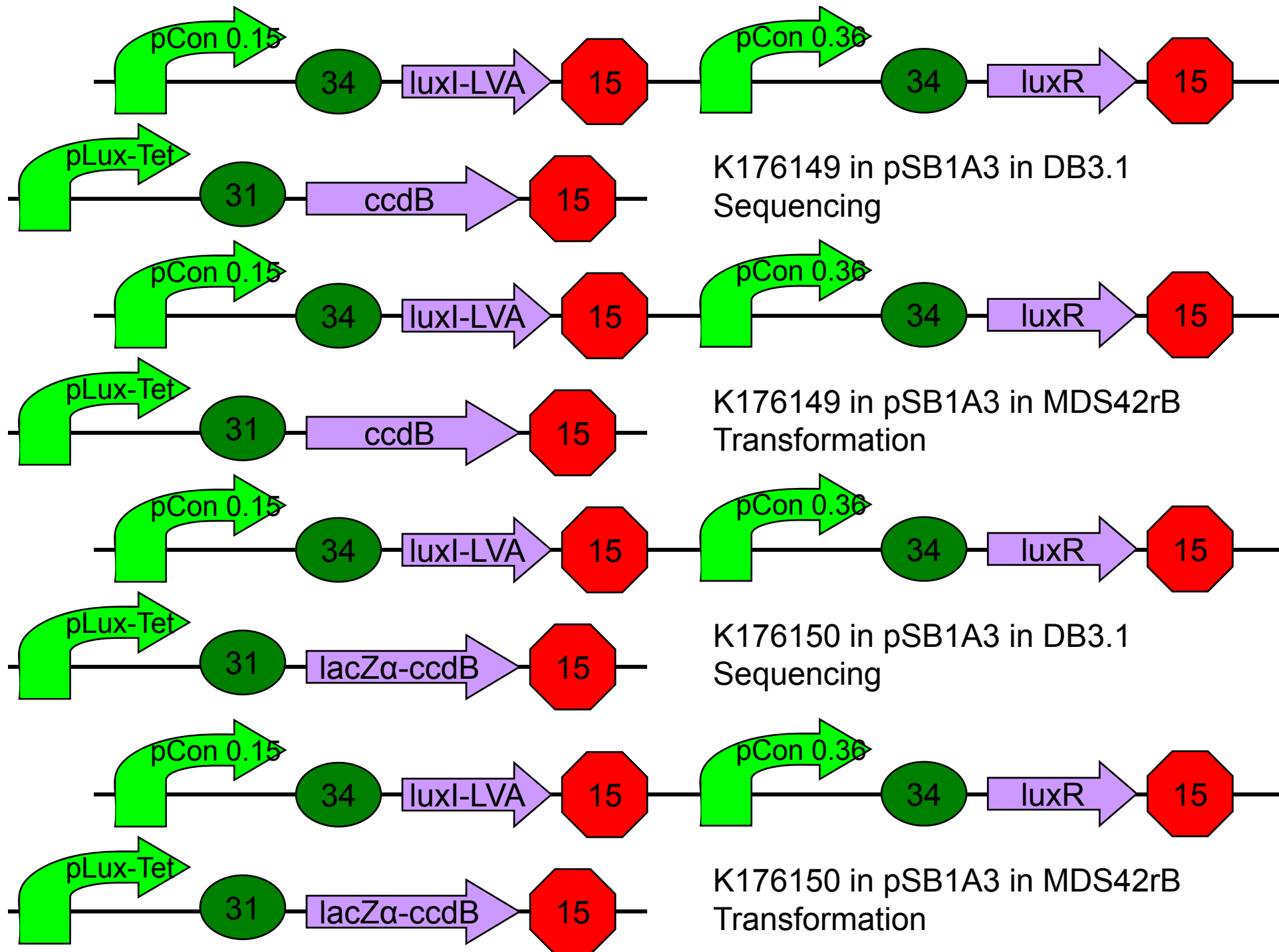



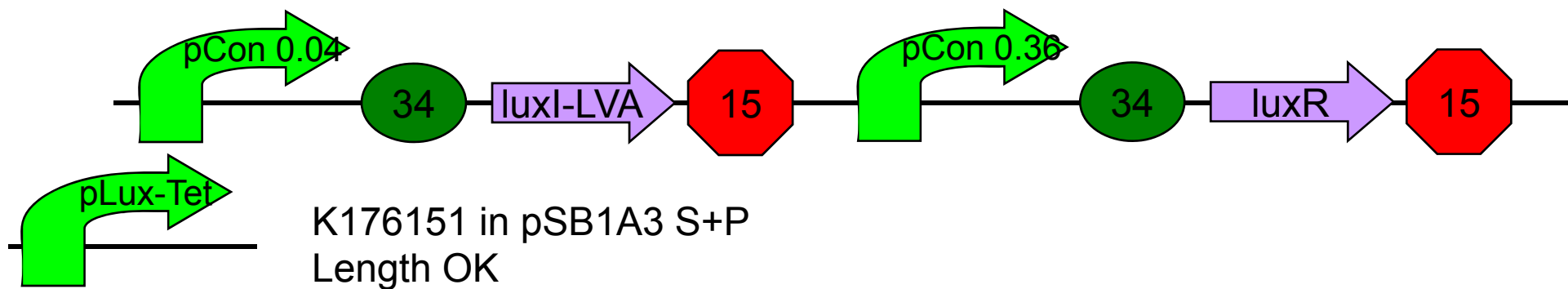
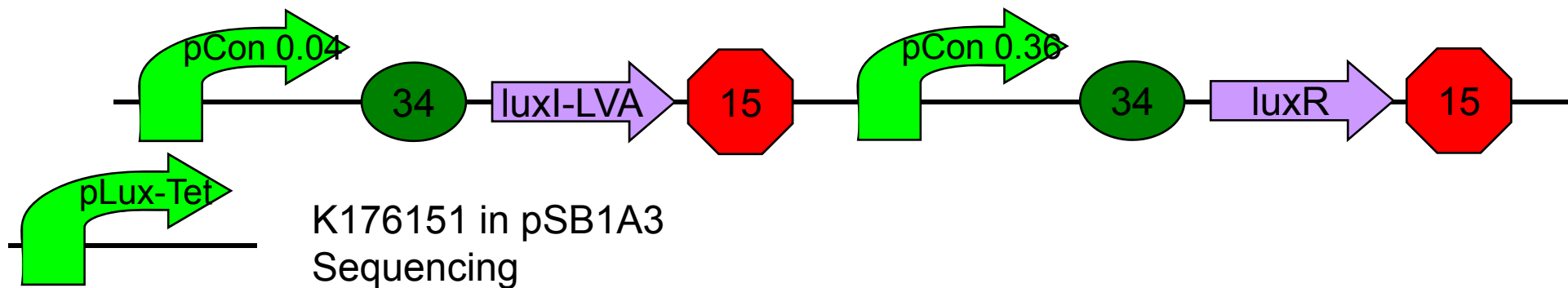

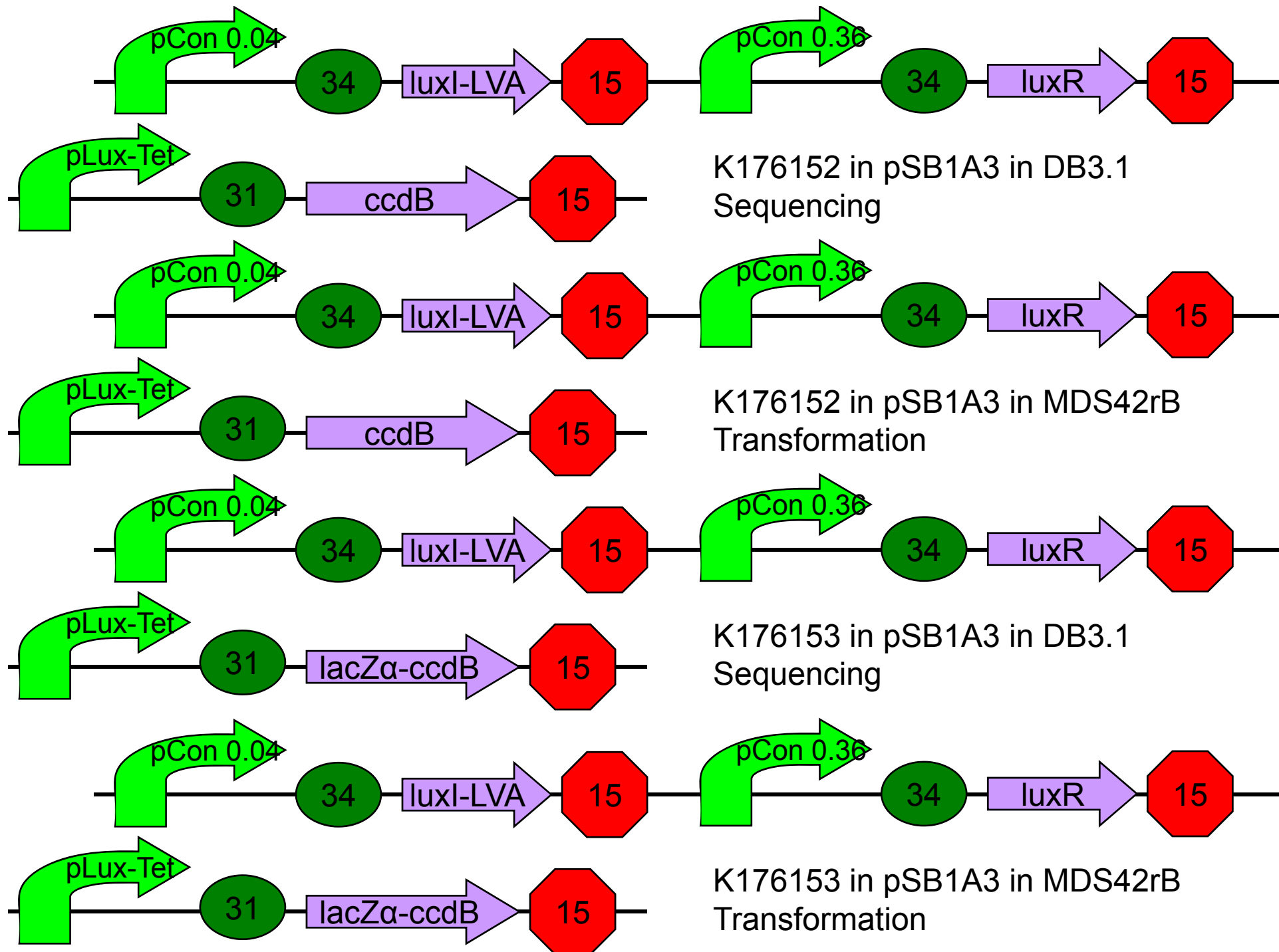

# pCon 0.04 luxI + luxR + B0031 lacZ $\alpha$ -ccdB

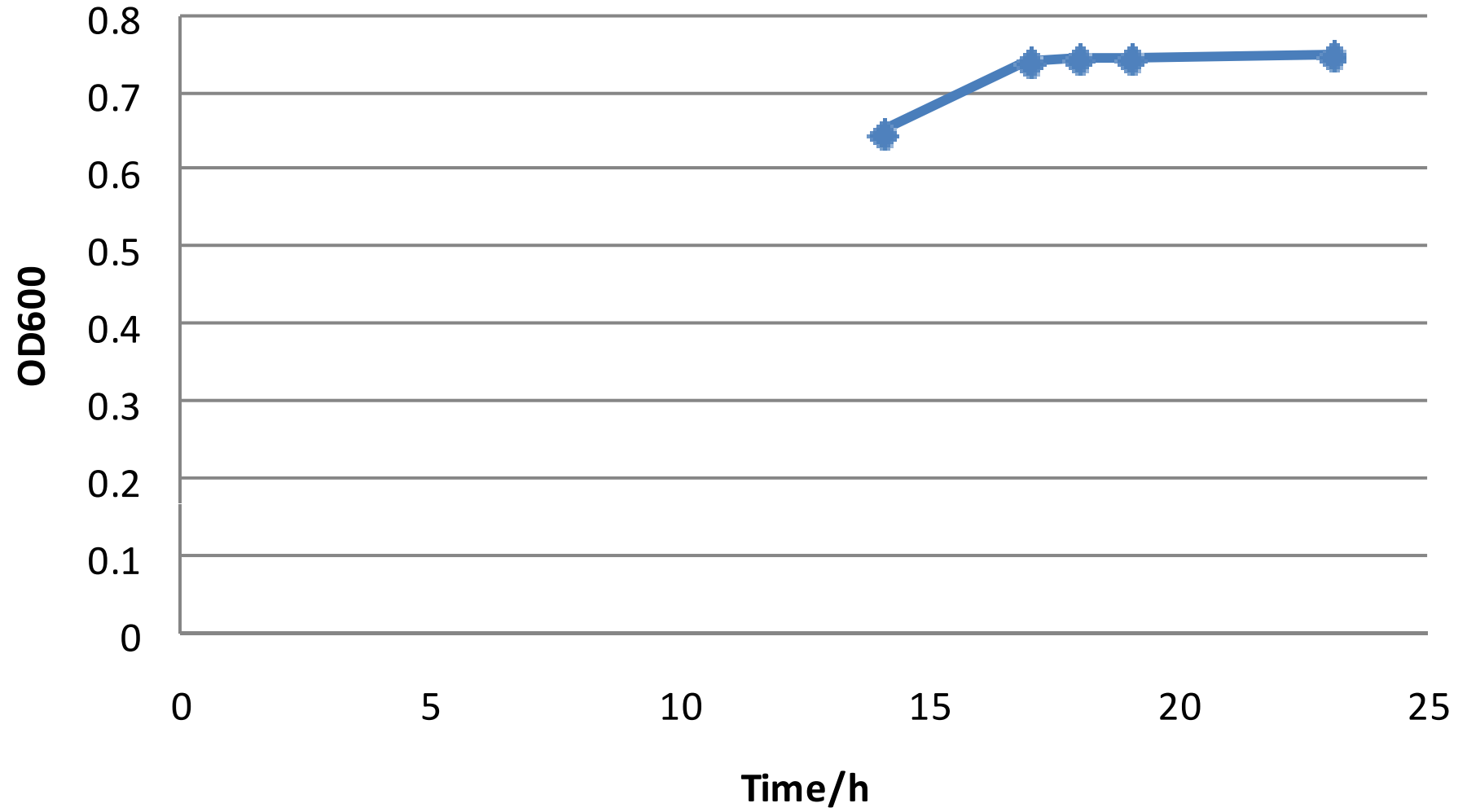

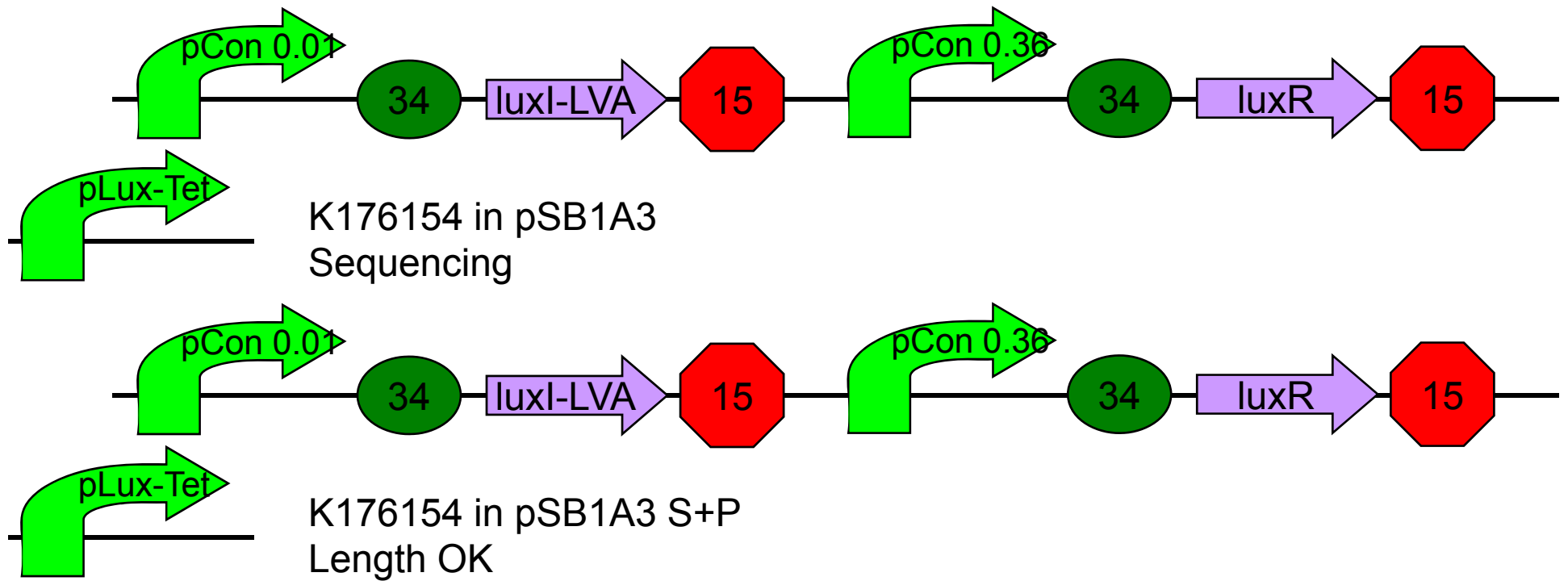

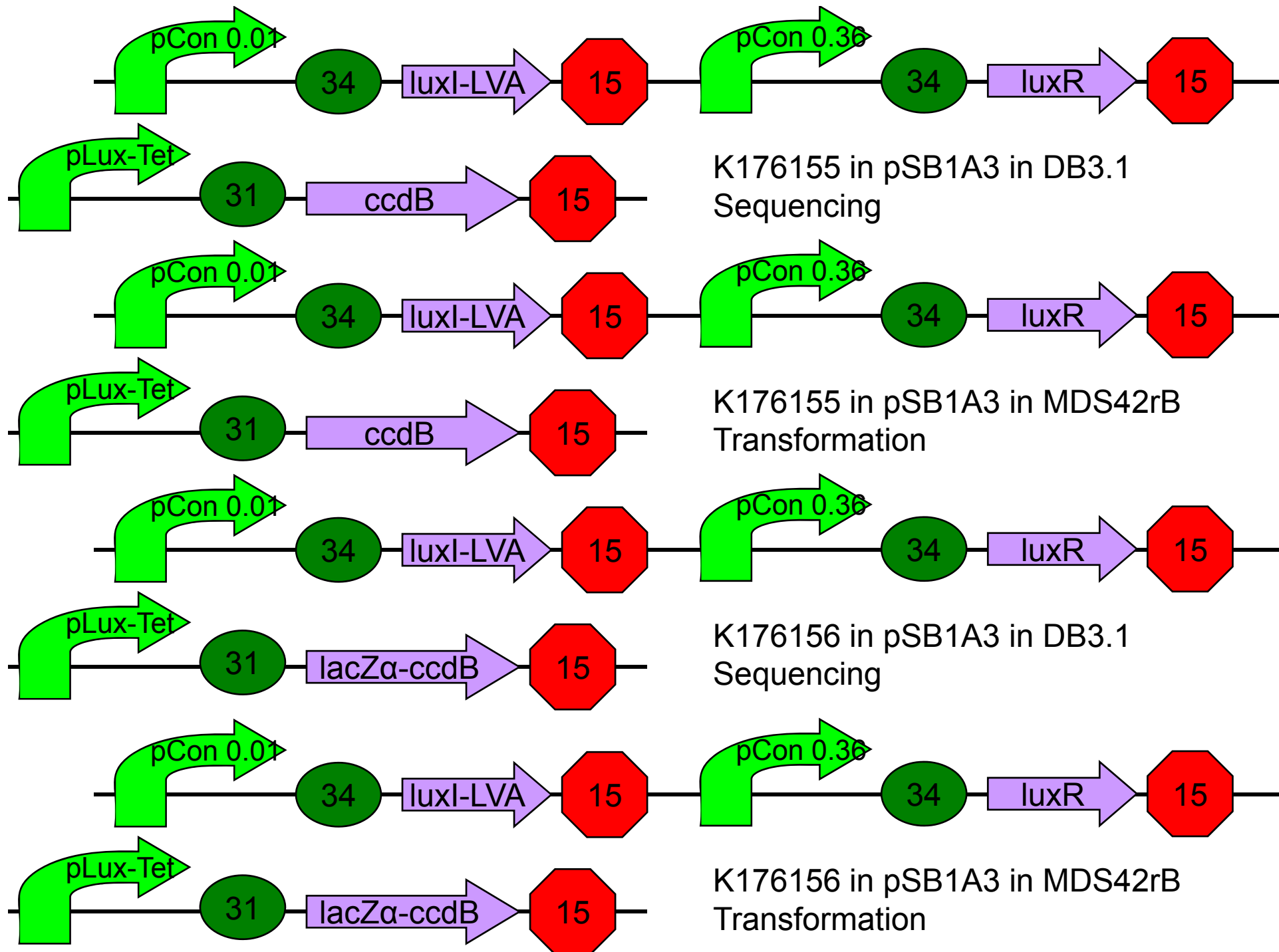

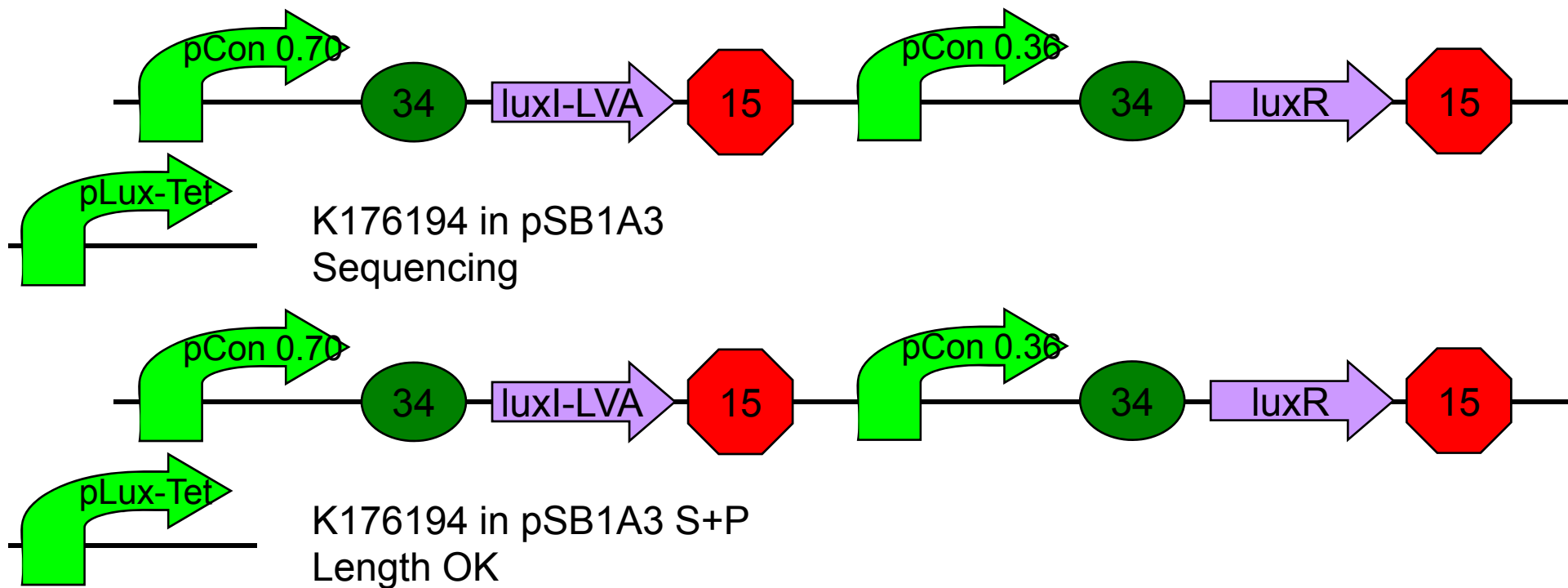

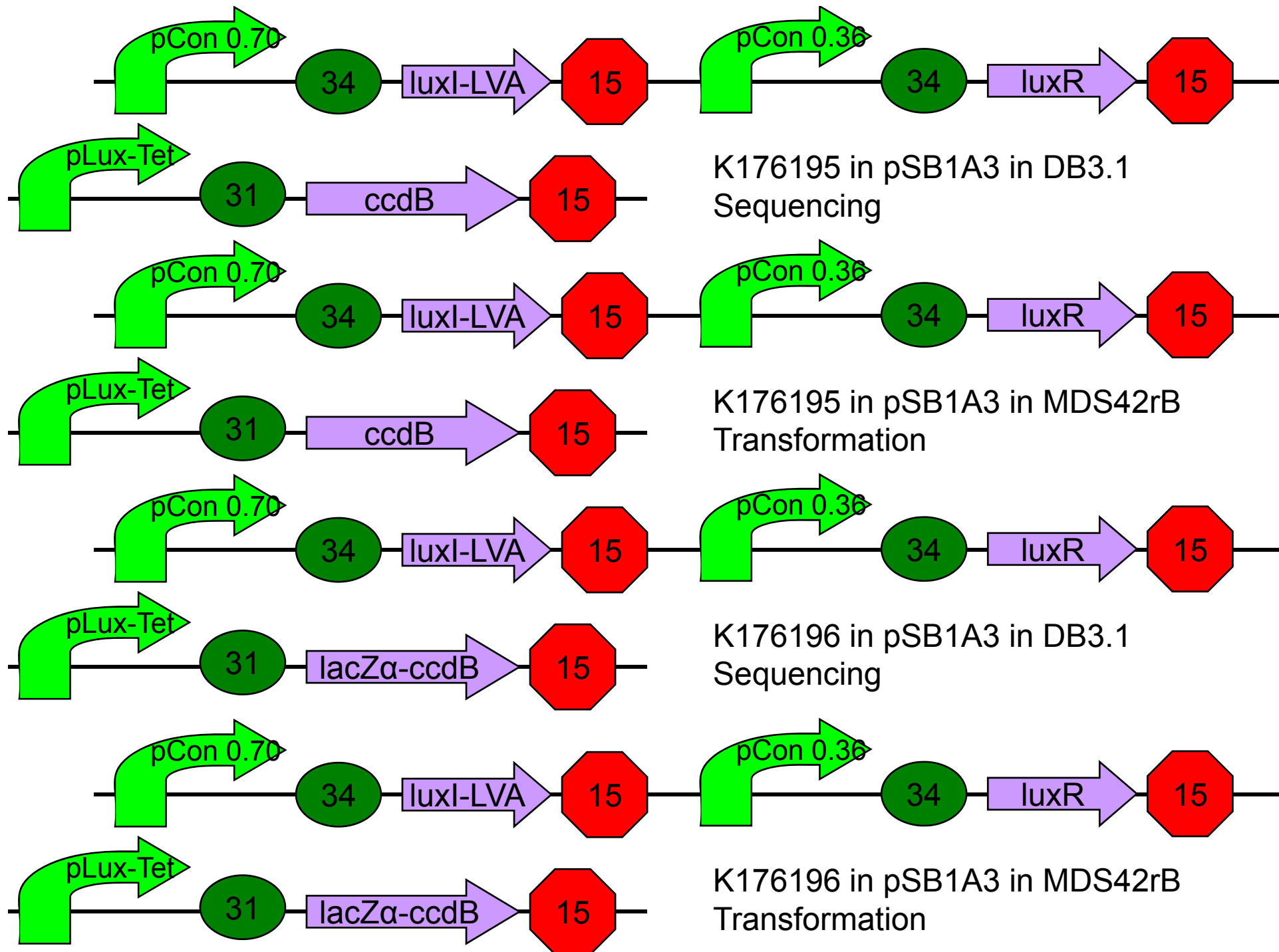

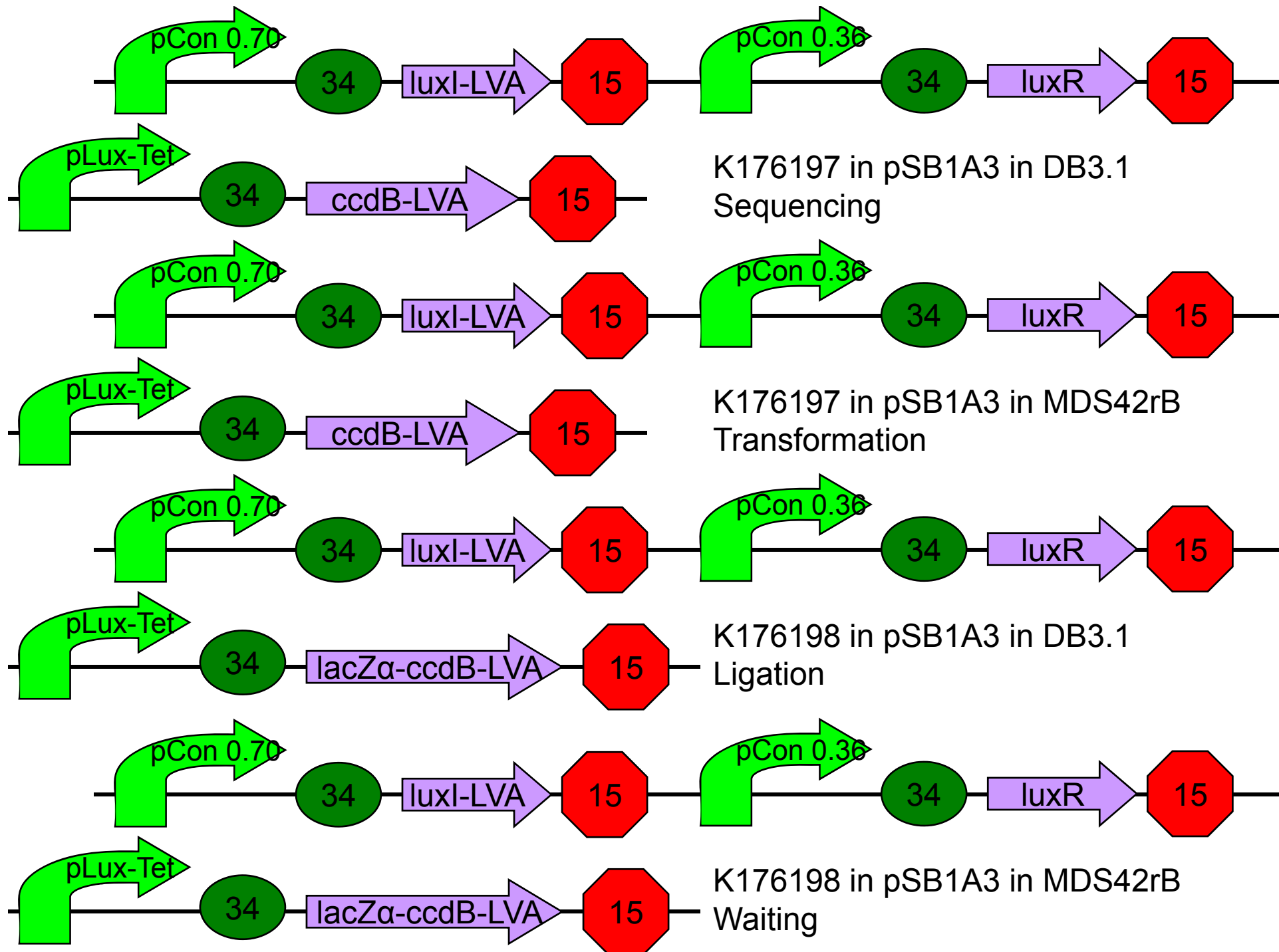



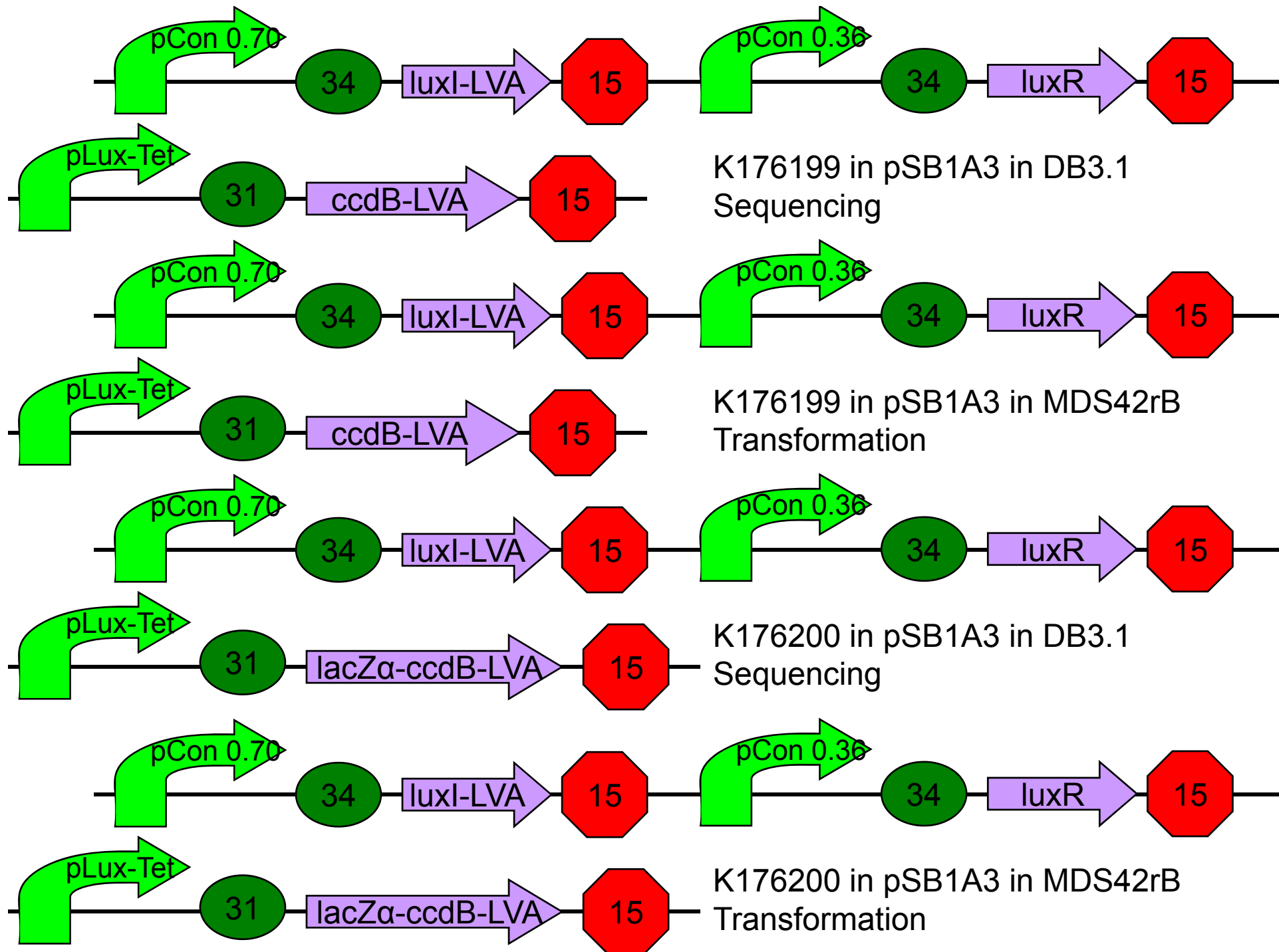

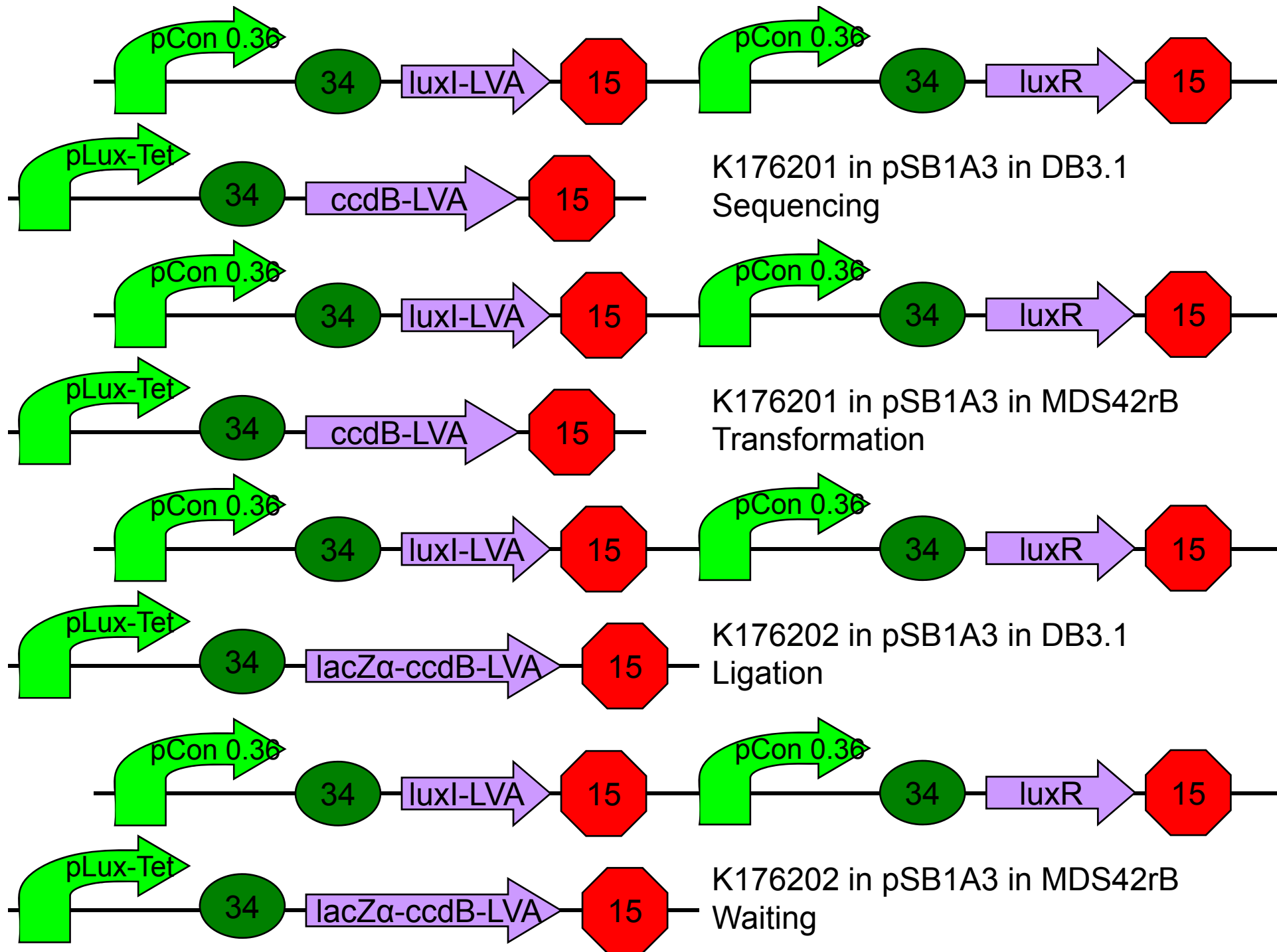

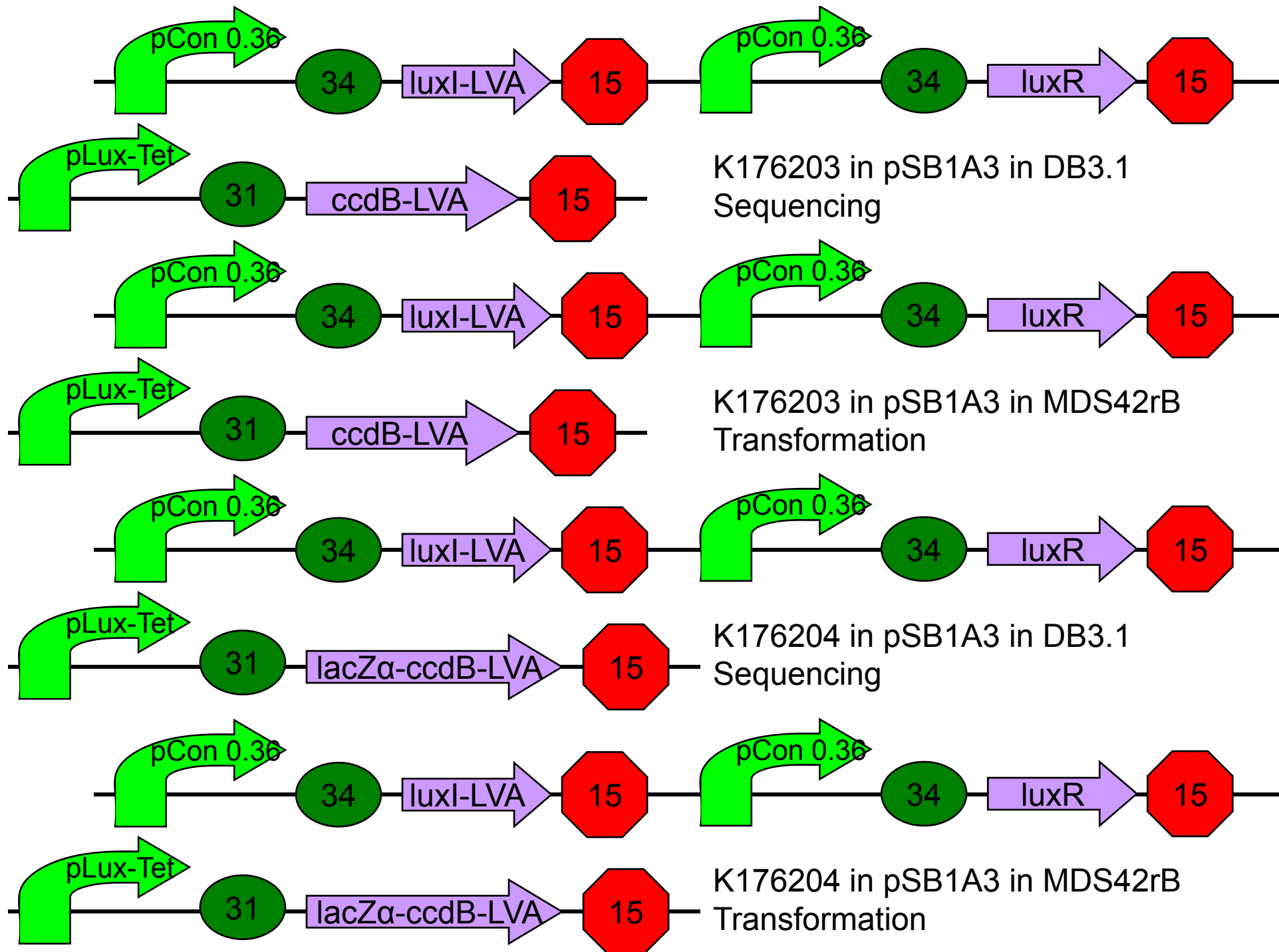

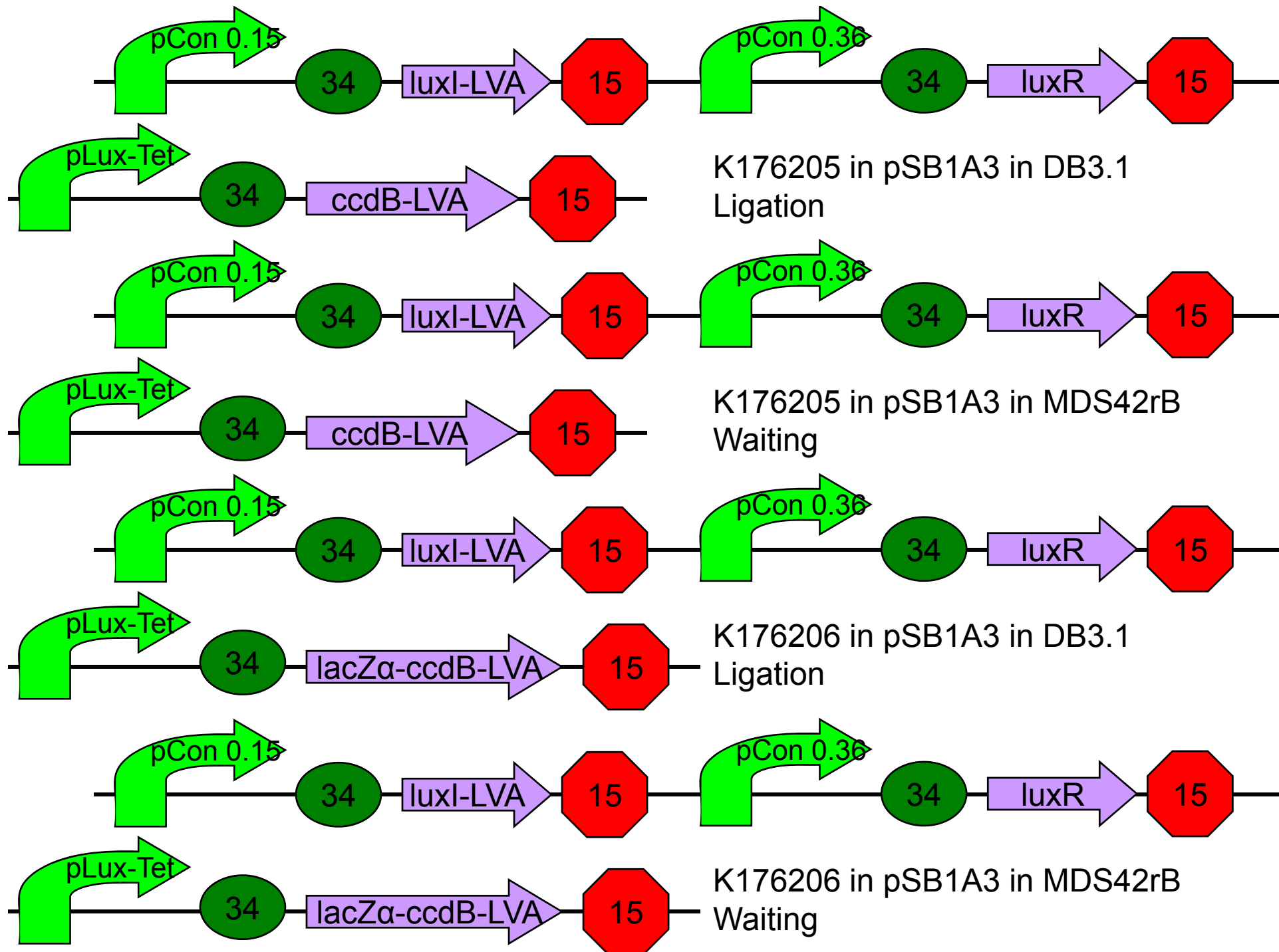

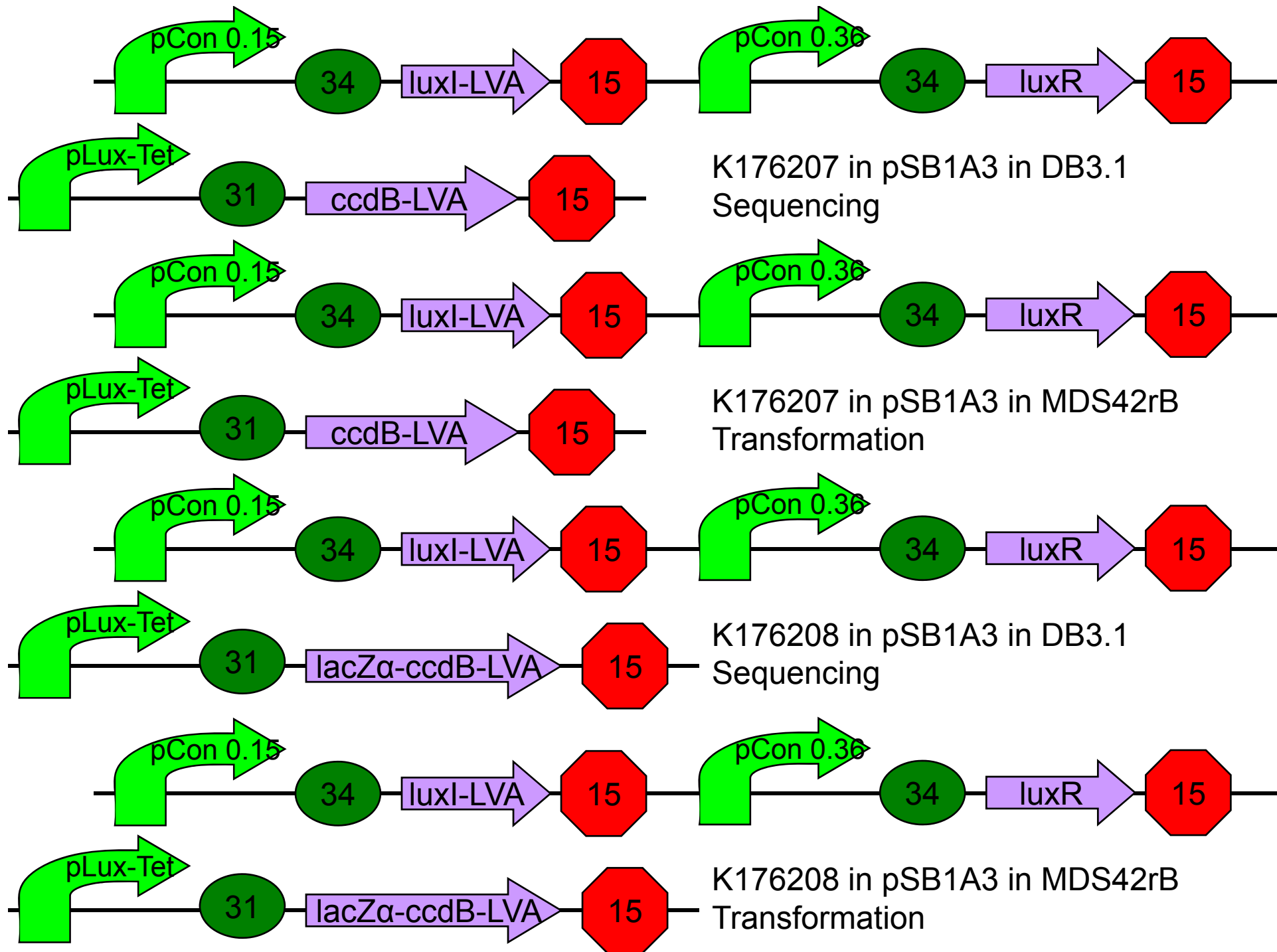

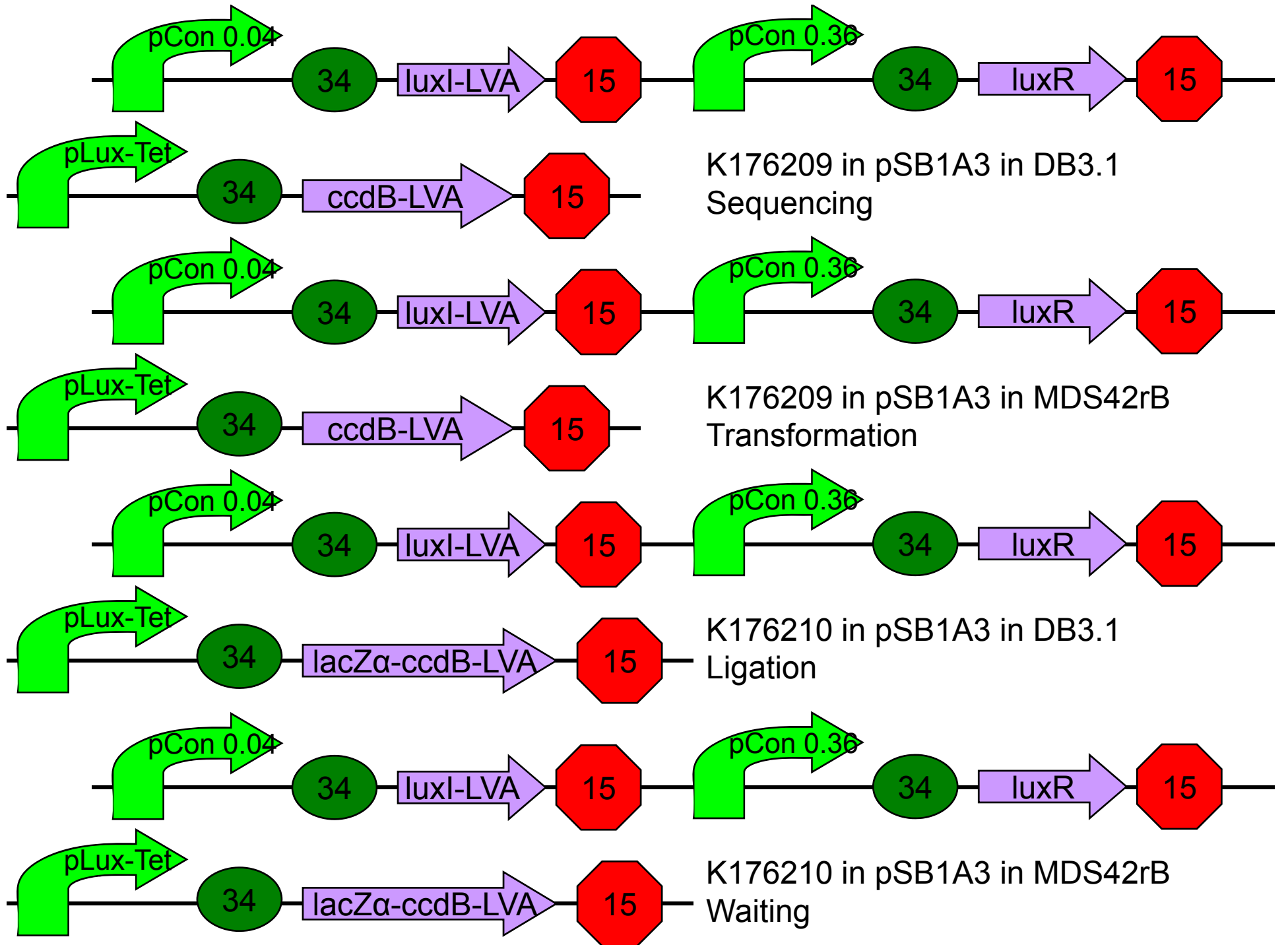

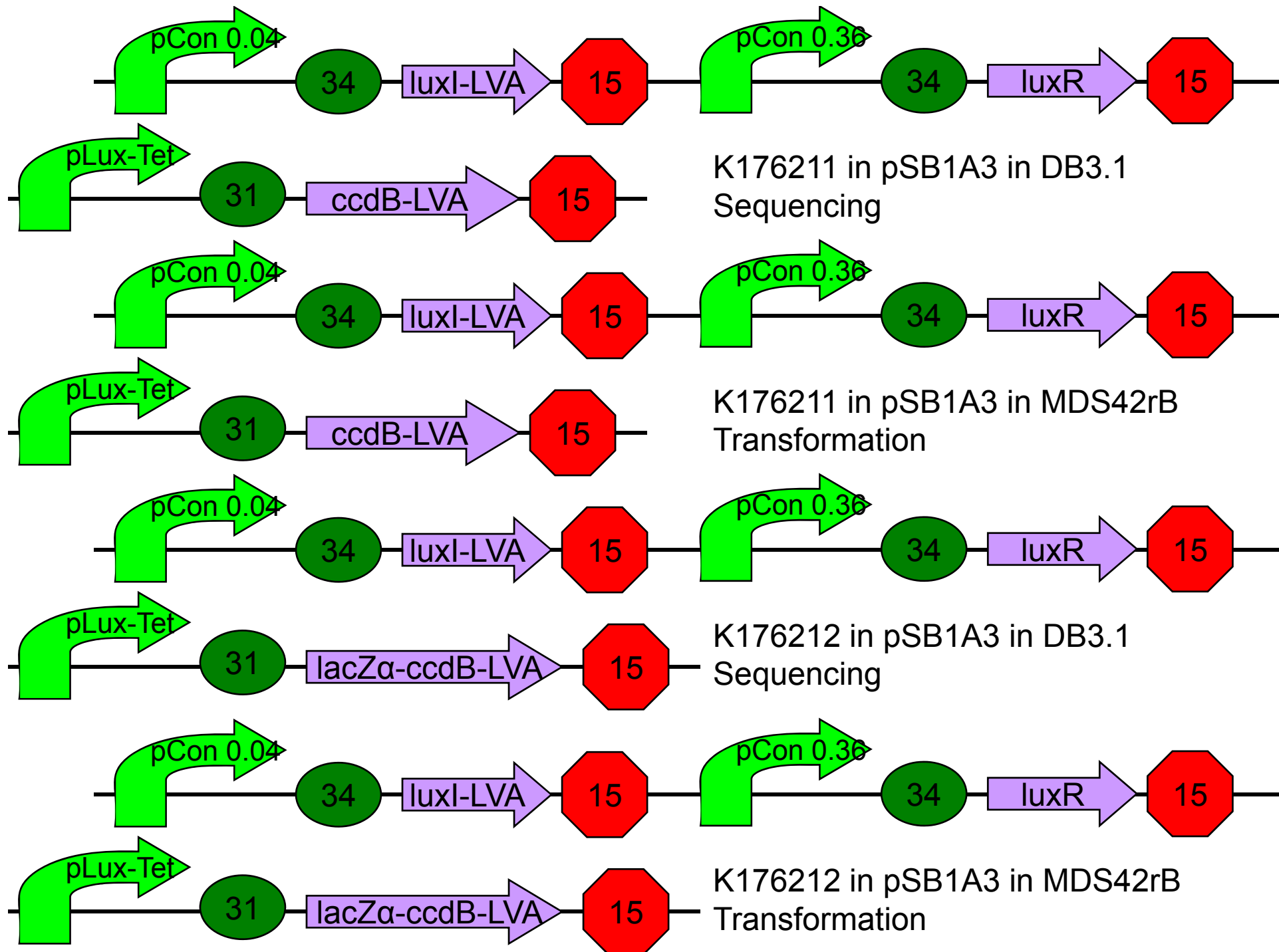

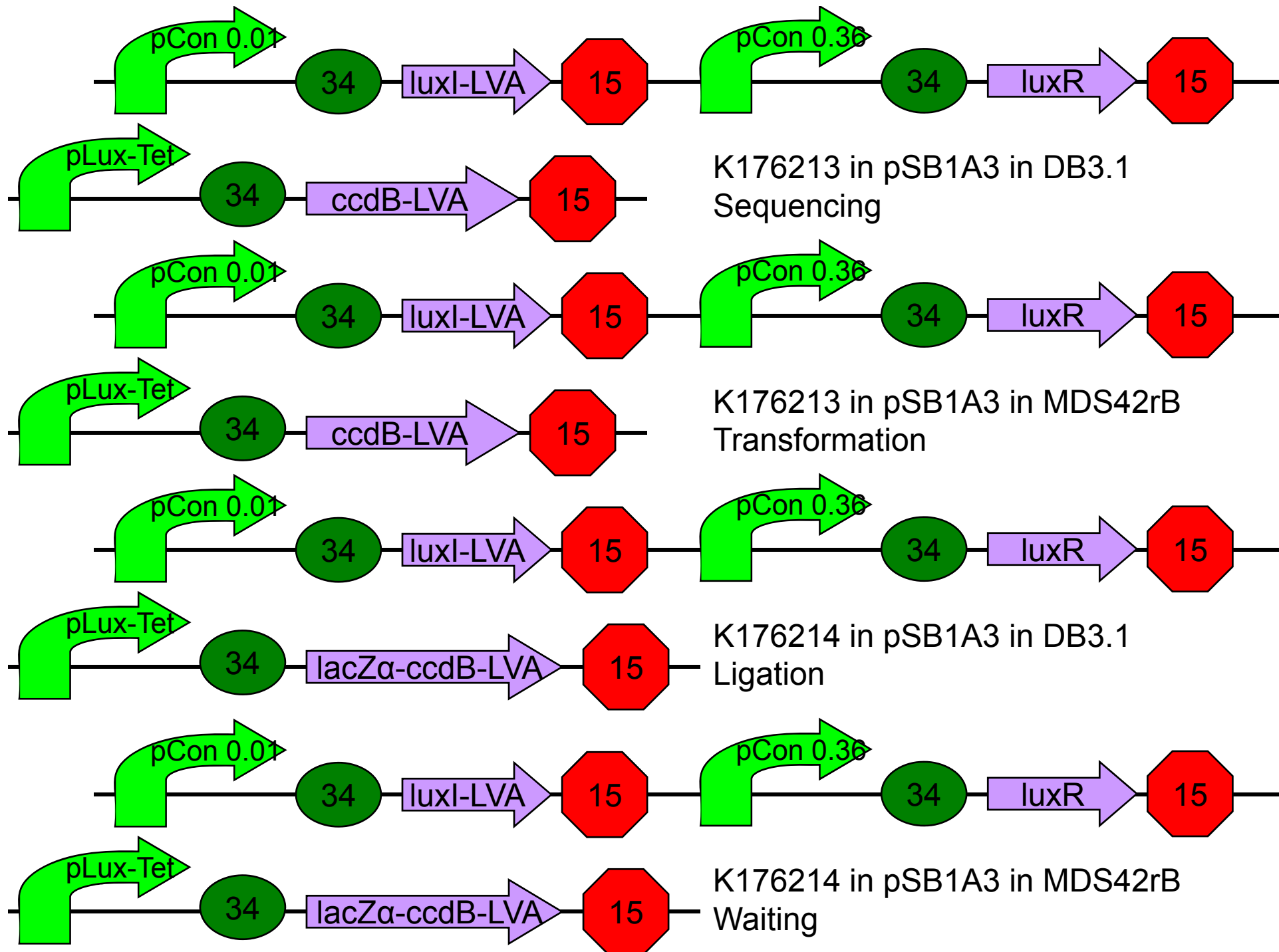



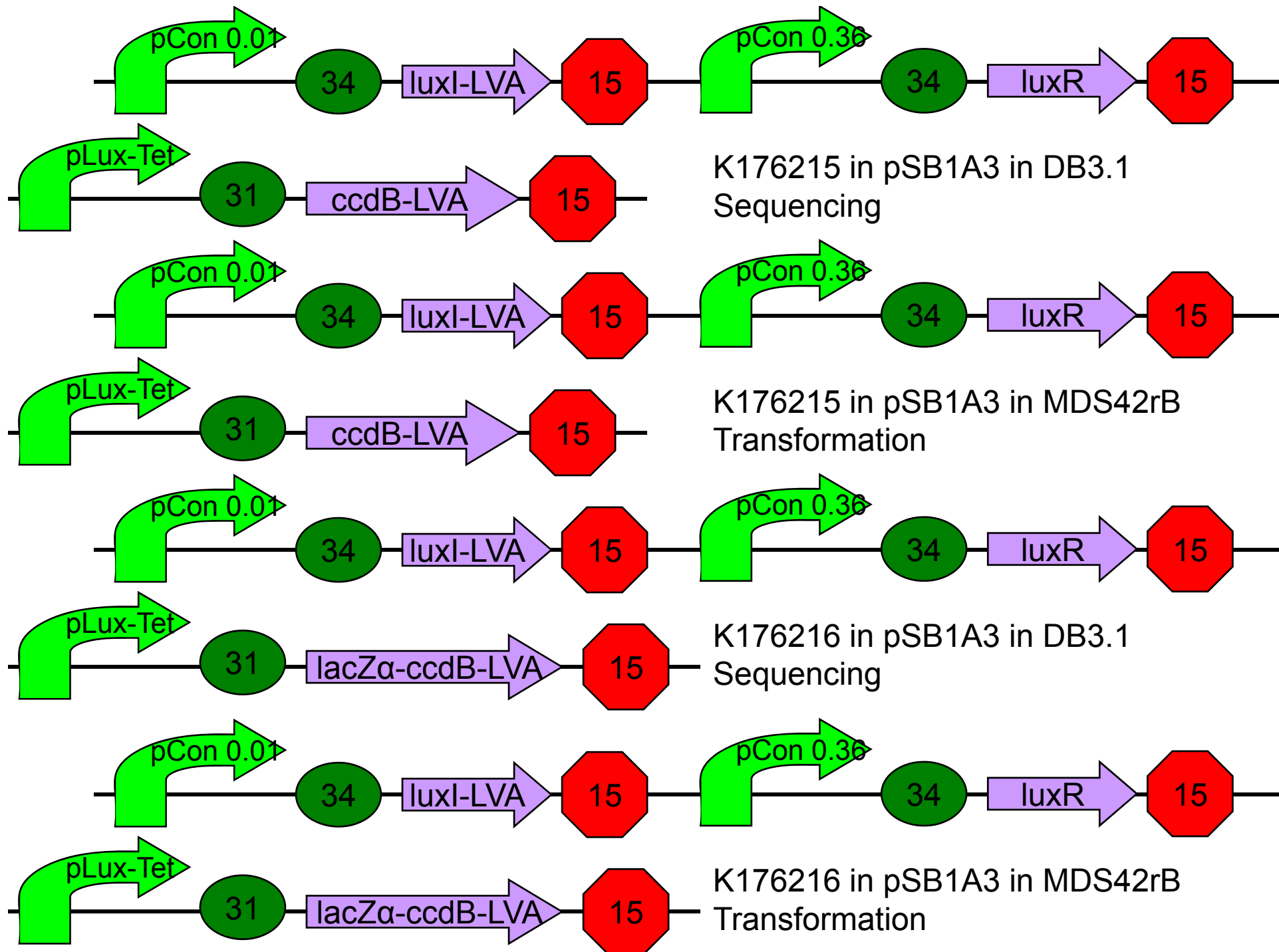

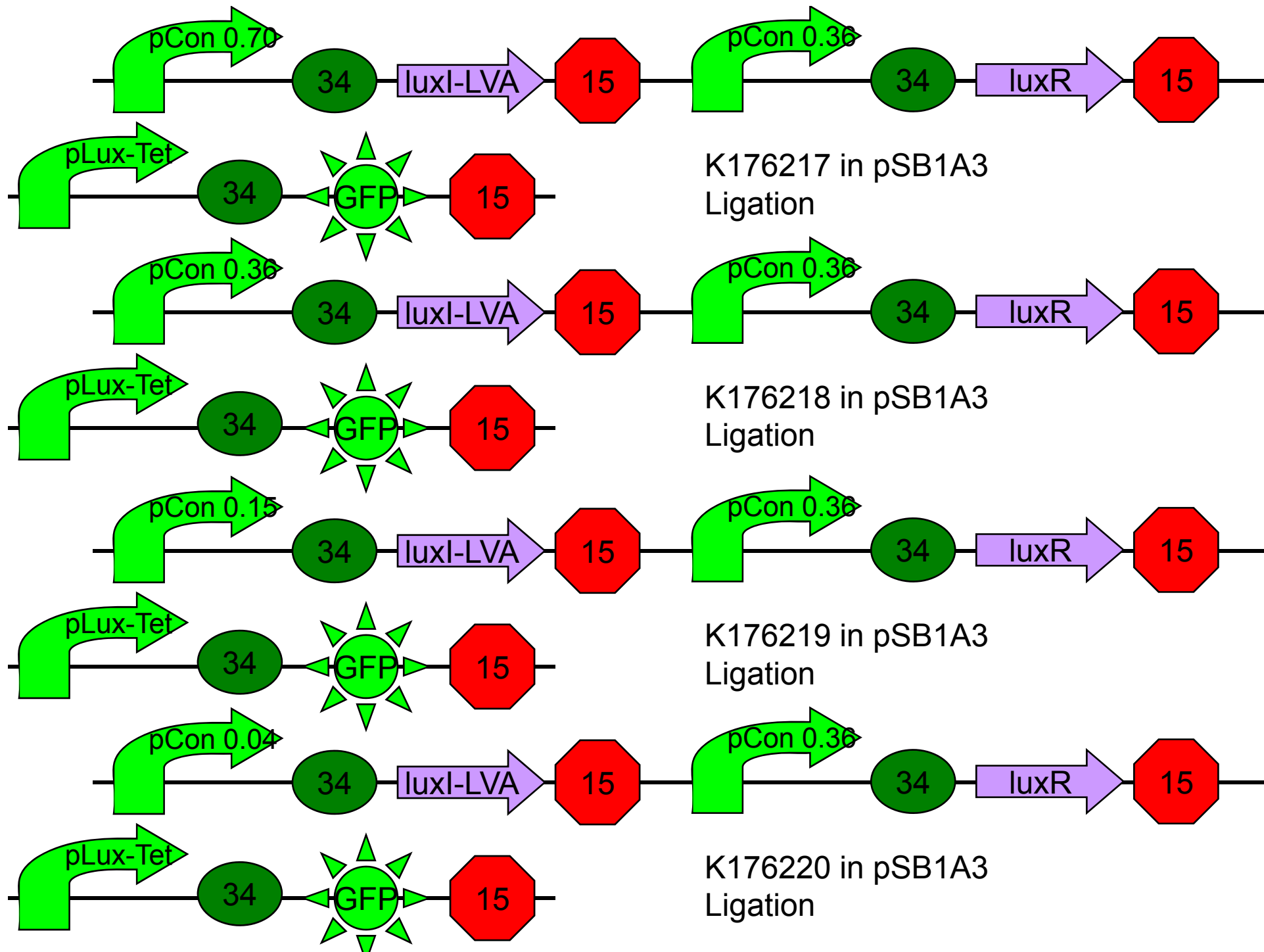

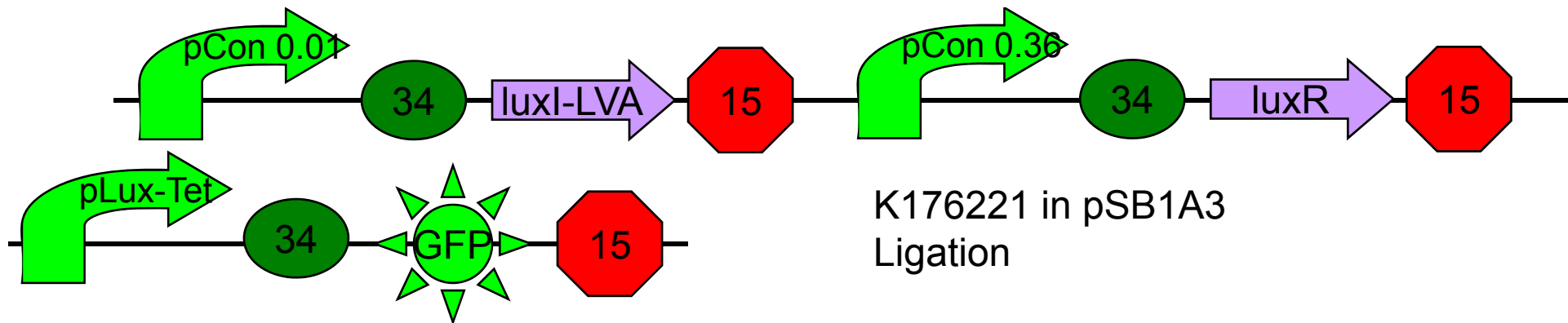

# luxI+luxR+GFP

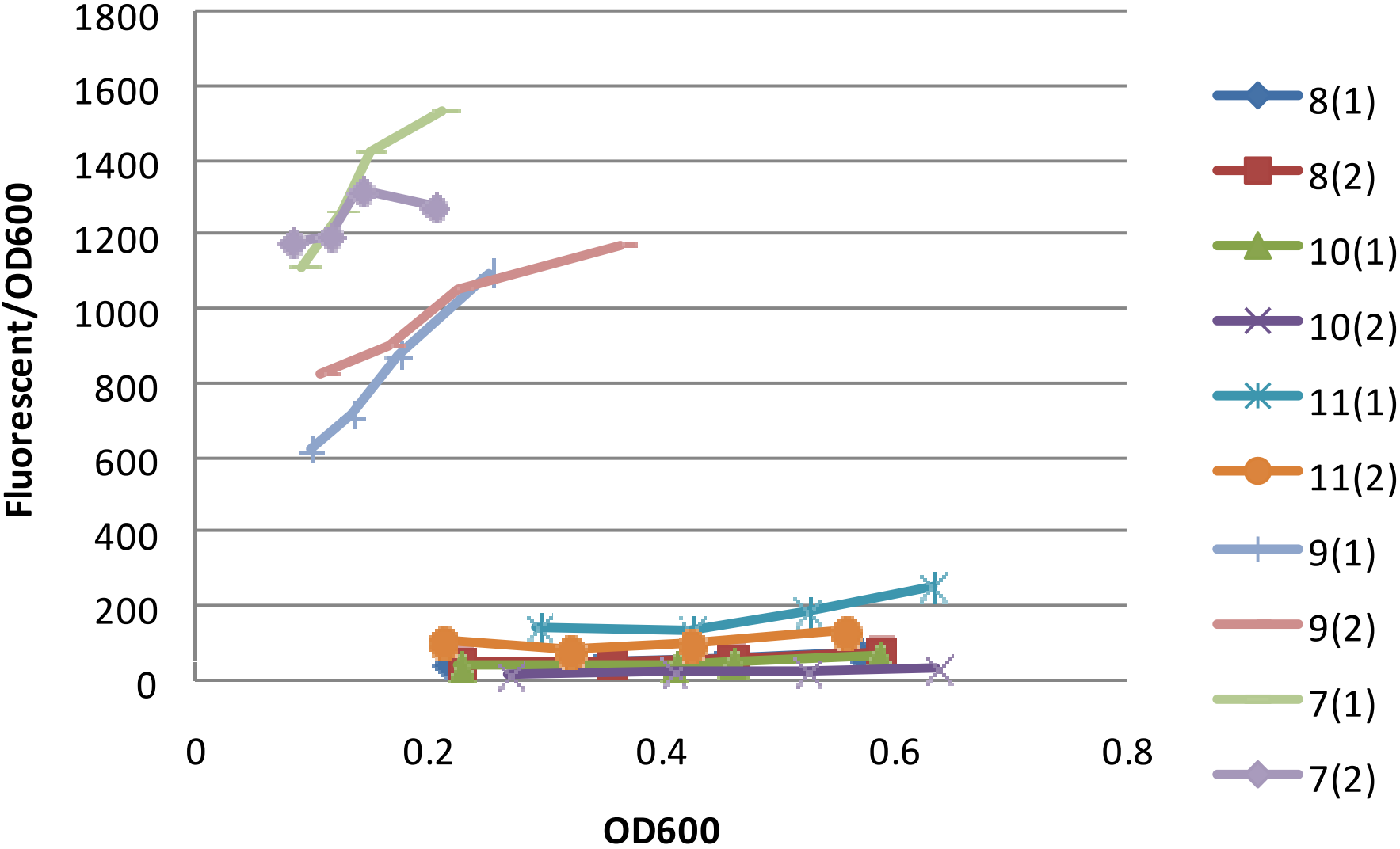



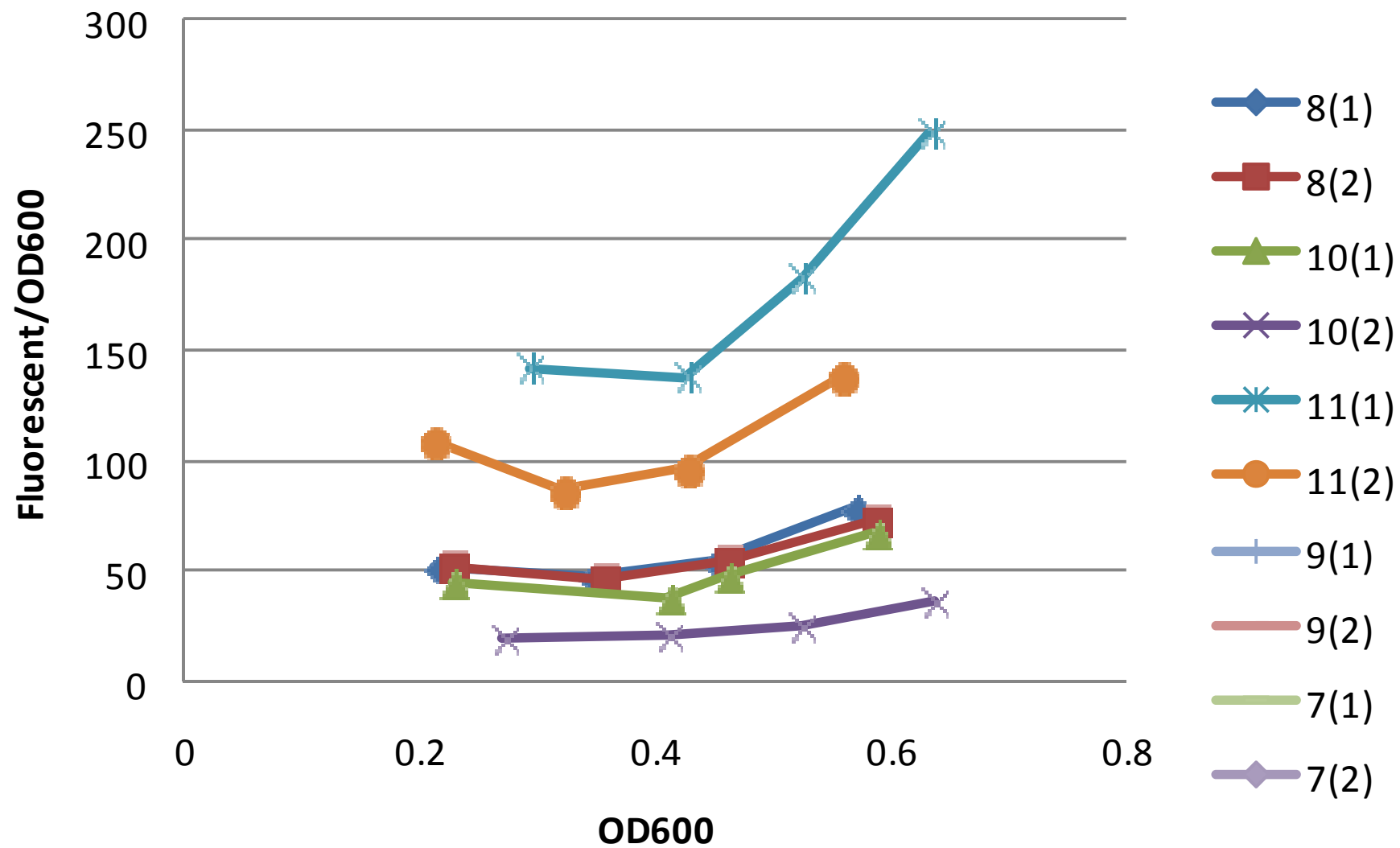





























# luxI+luxR+GFP





15

	K176037 E+S Synthesis OK		K176037 in pSB1A3 Sequence OK		K176047 Synthesis OK
	K176038 E+S Synthesis OK		K176038 in pSB1A3 Sequence OK		K176048 Synthesis OK
	K176039 E+S Synthesis OK		K176039 in pSB1A3 Sequence OK		K176049 Synthesis OK
	K176040 E+S Synthesis OK		K176040 in pSB1A3 Sequence OK		K176050 Synthesis OK
	K176041 E+S Synthesis OK		K176041 in pSB1A3 Sequence OK		K176051 Synthesis OK
	K176042 E+S Synthesis OK		K176042 in pSB1A3 Sequencing		K176052 Synthesis OK
	K176043 E+S Synthesis OK		K176043 in pSB1A3 Sequence OK		K176053 Synthesis OK
	K176044 E+S Synthesis OK		K176044 in pSB1A3 Sequence OK		K176054 Synthesis OK
	K176045 E+S Synthesis OK		K176045 in pSB1A3 Sequence OK		K176055 Synthesis OK
	K176046 E+S Synthesis OK		K176046 in pSB1A3 Sequence OK		K176056 Synthesis OK
—	pSB1A3 E+S Length OK				

16

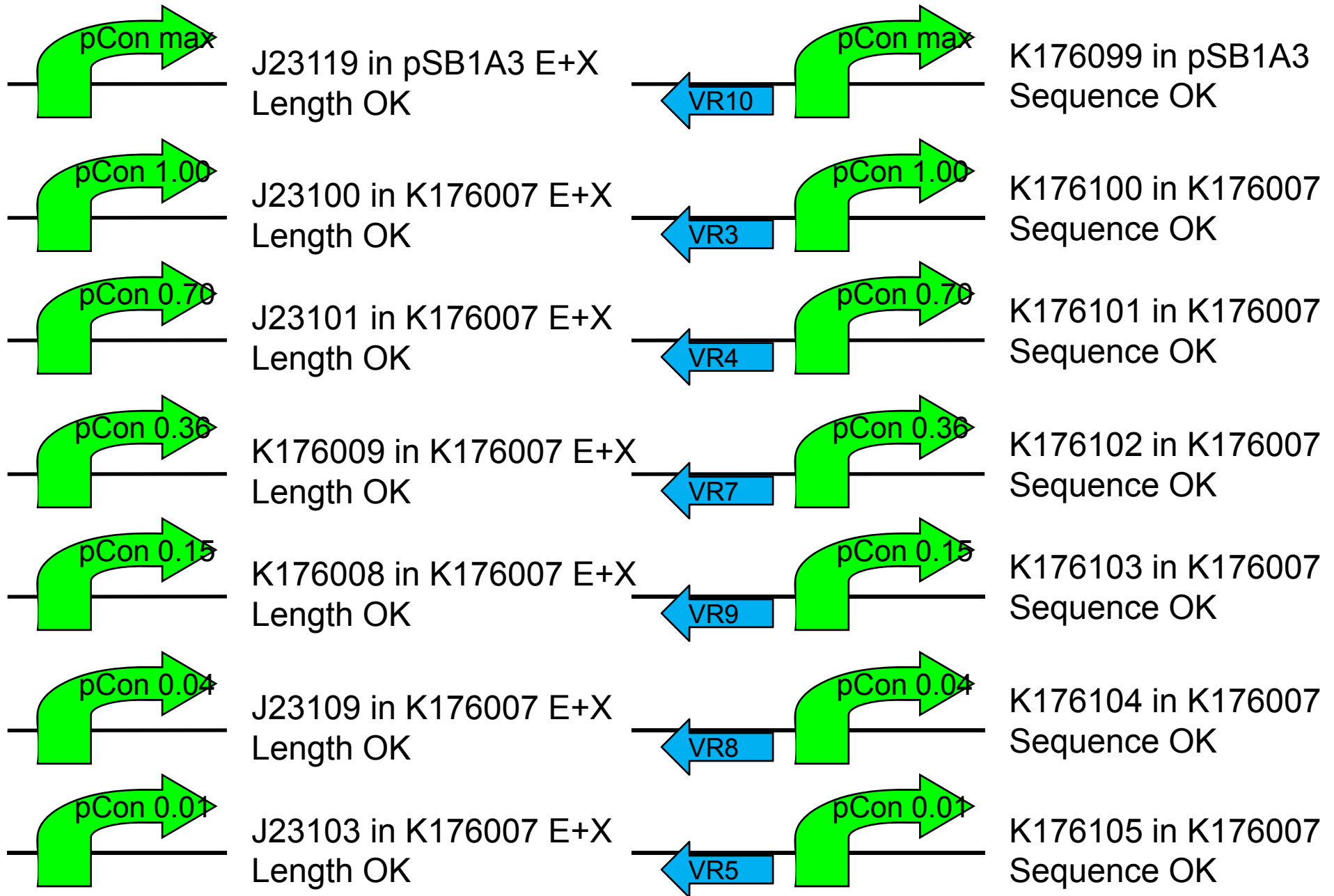



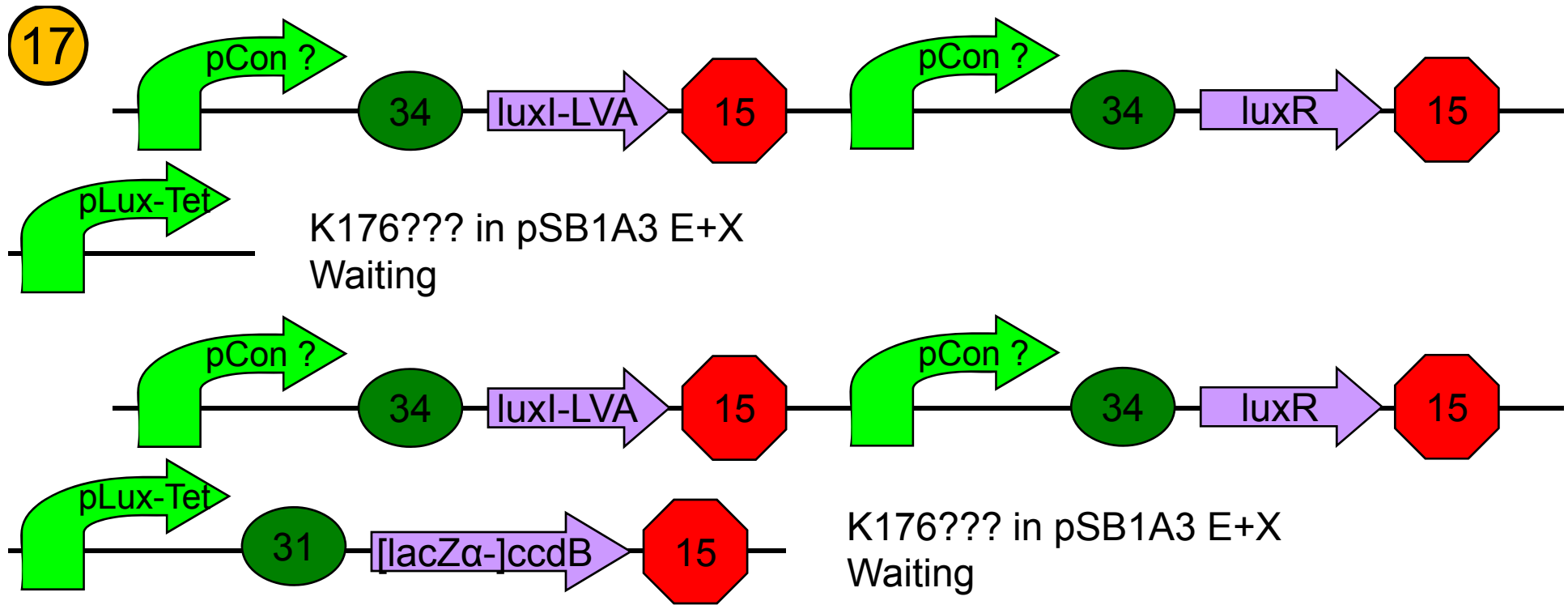

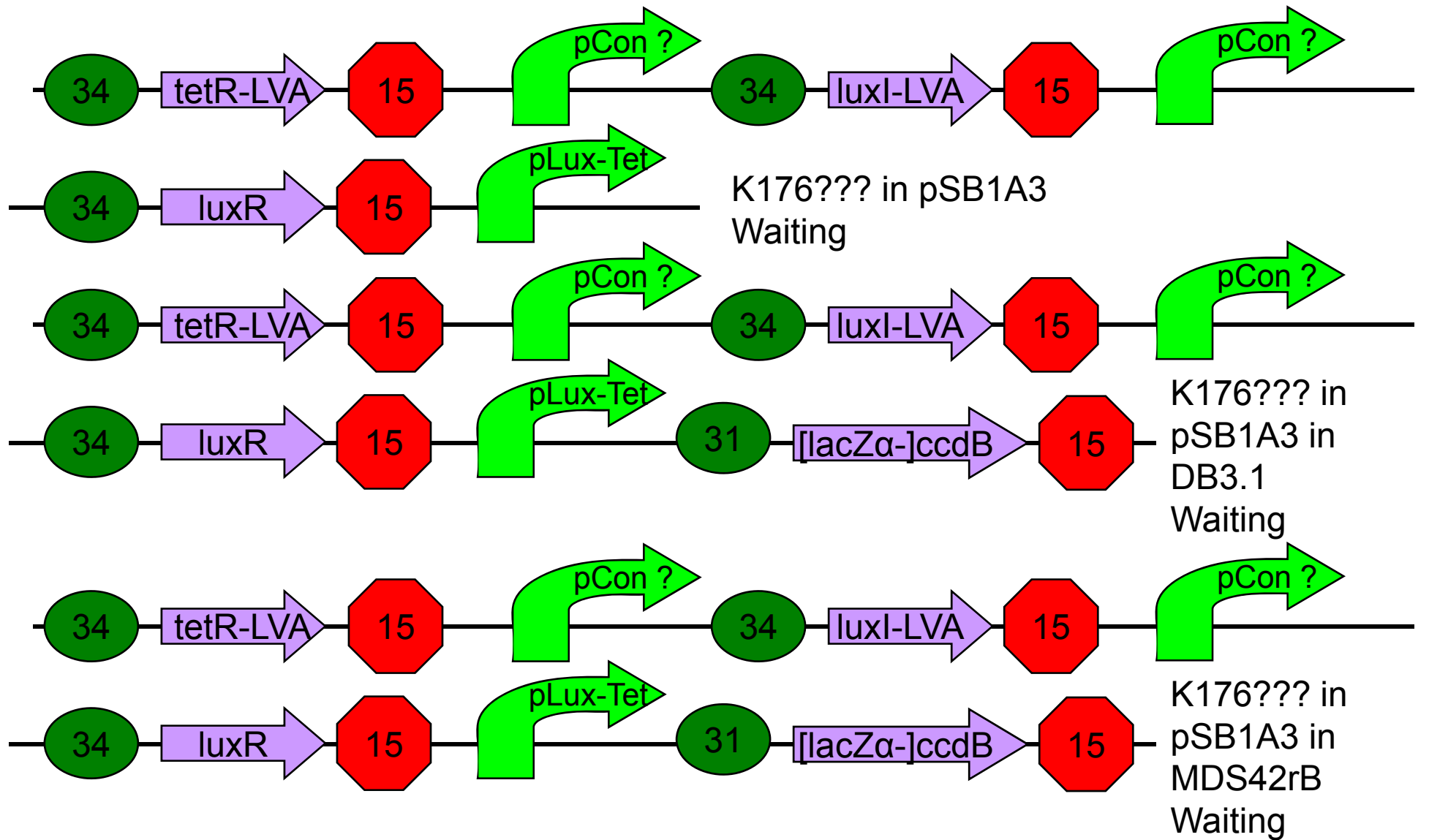

18

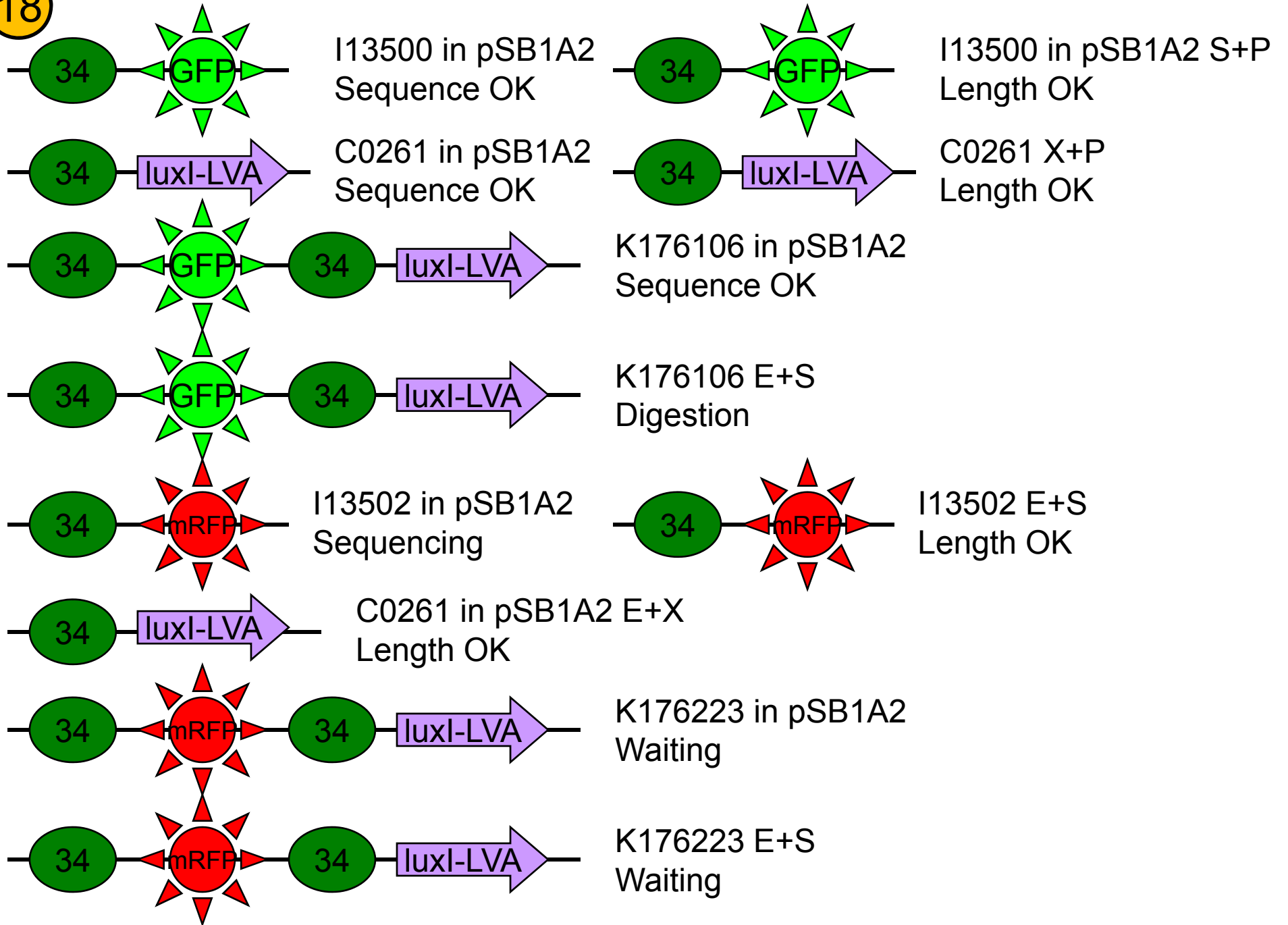

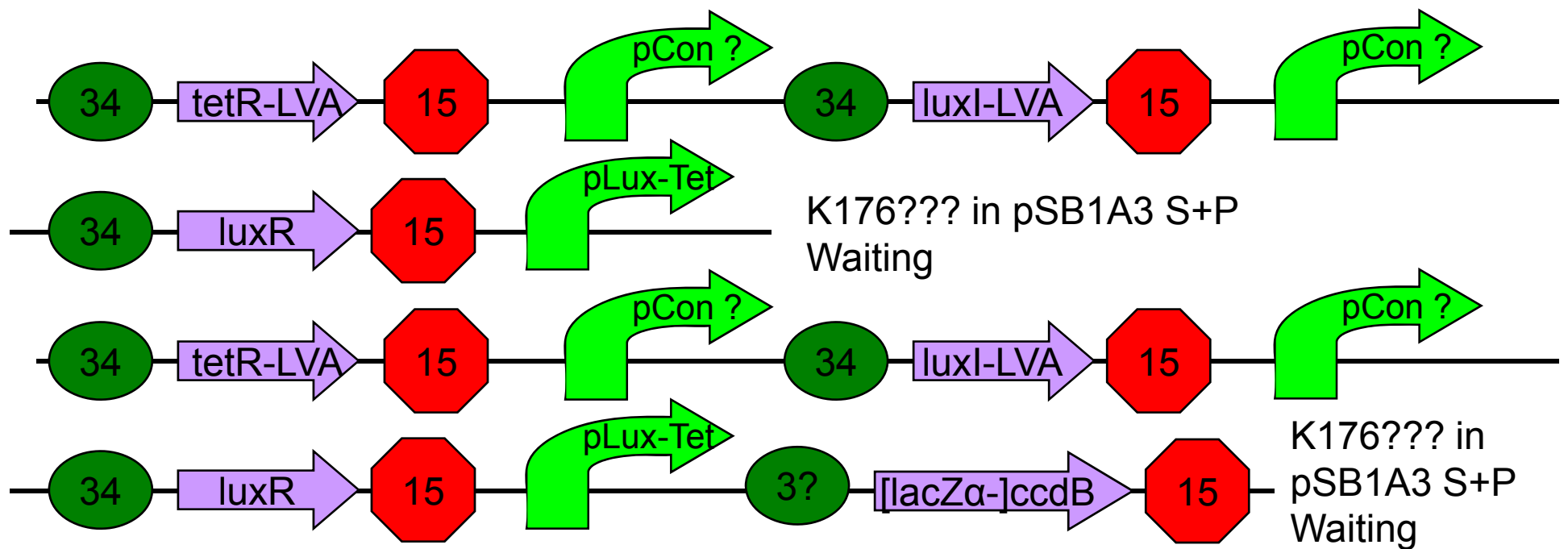

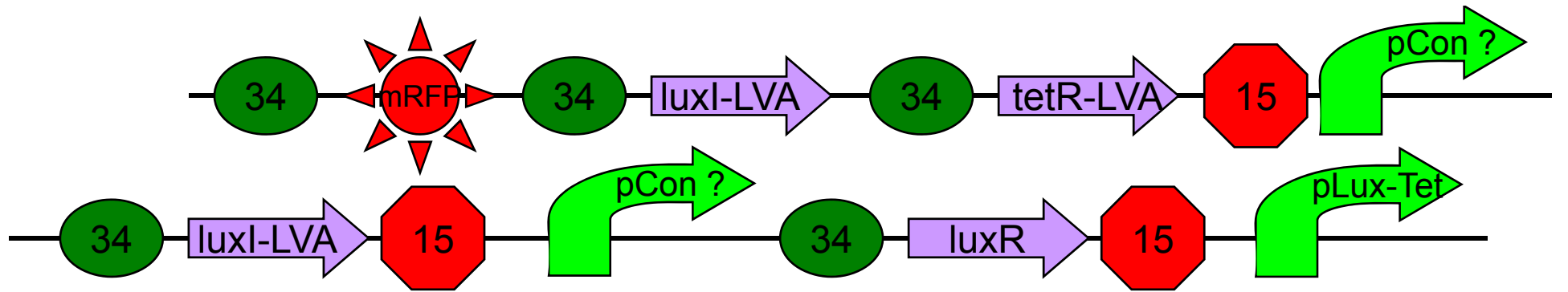

K176??? in pSB1A3  
Waiting

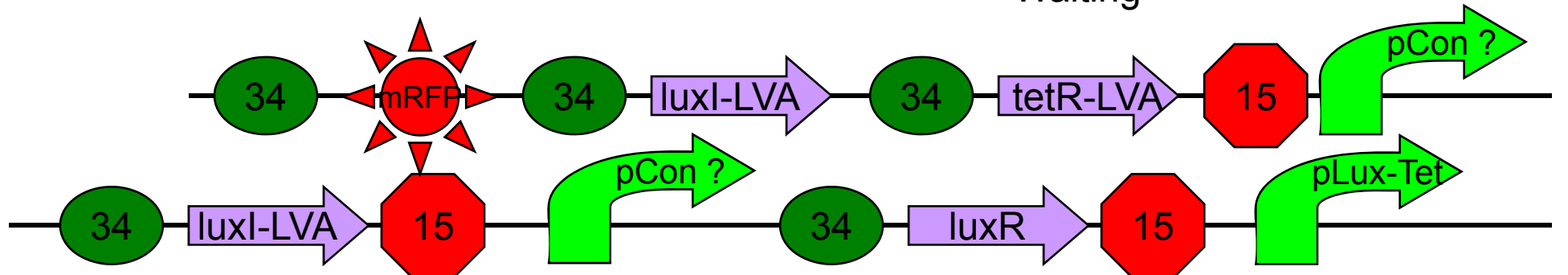

K176??? in pSB1A3 in DB3.1  
Waiting

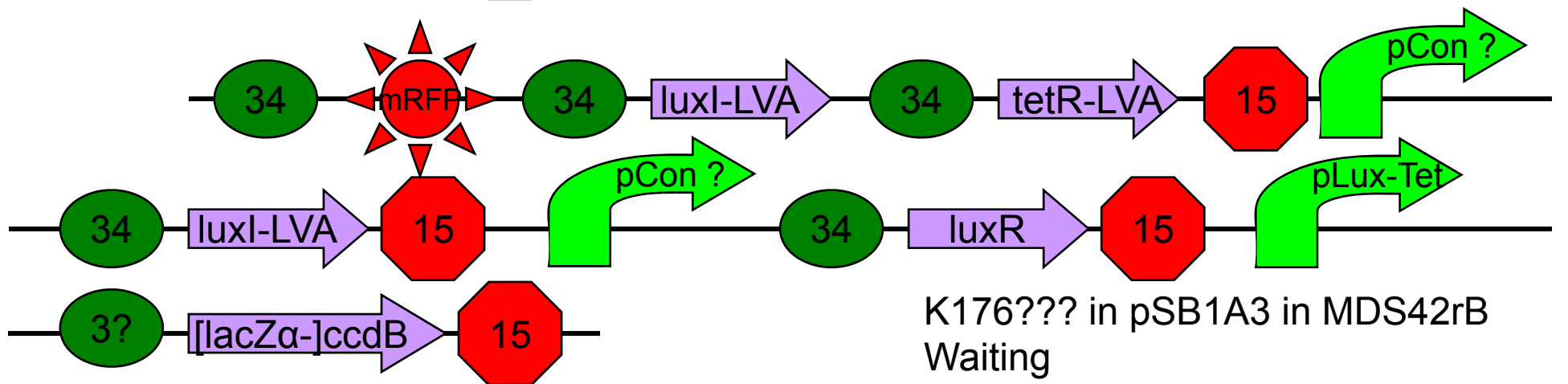

K176??? in pSB1A3 in MDS42rB  
Waiting

19

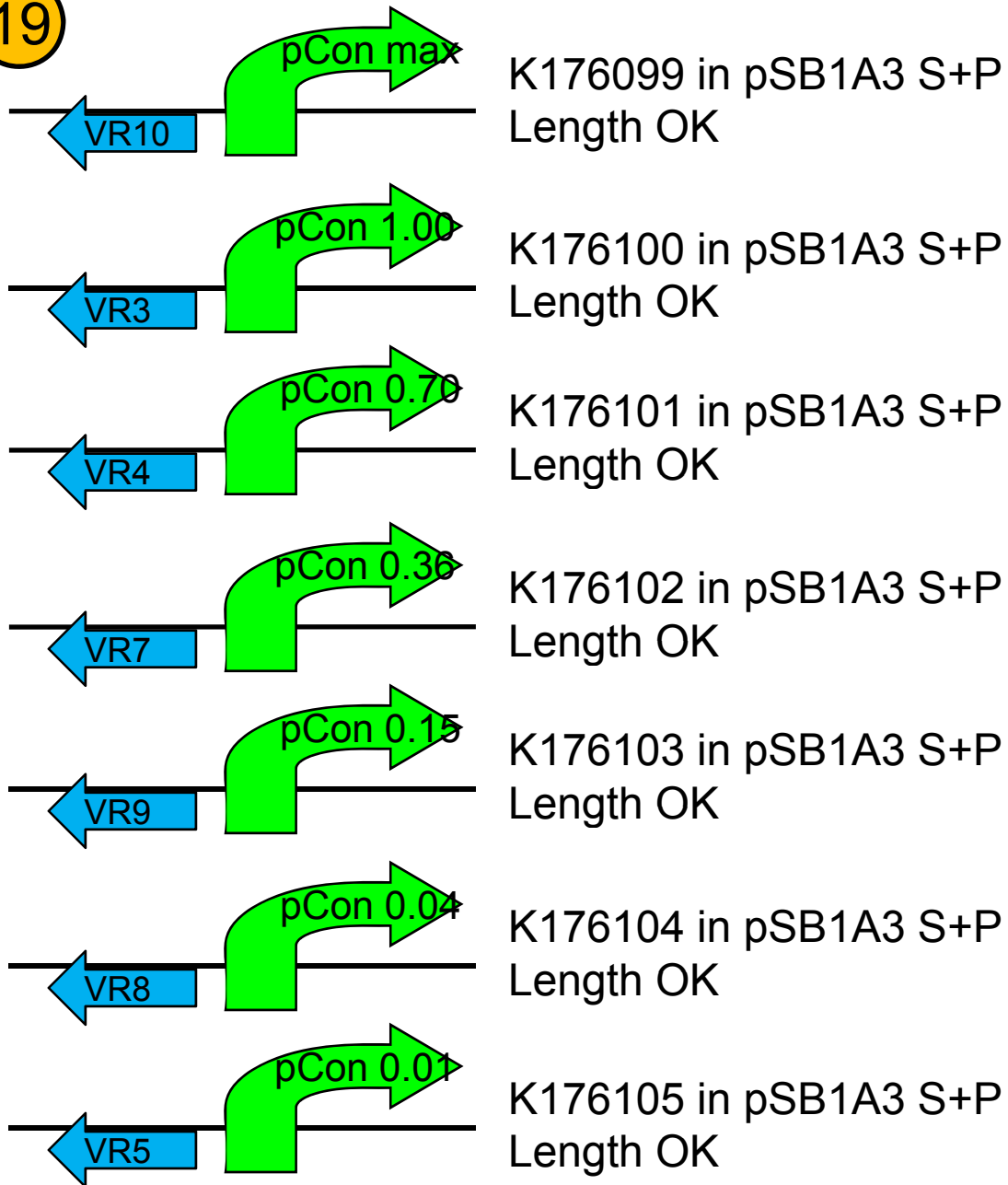



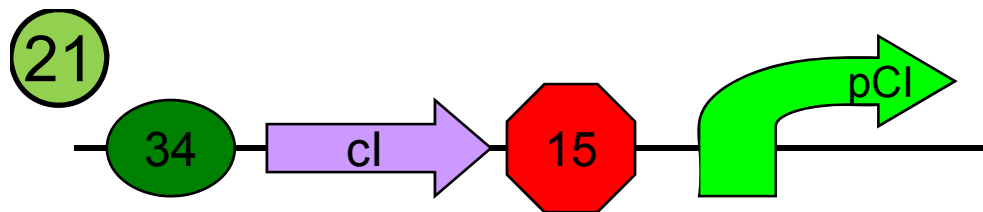

Q04510 in pSB2K3  
Sequence OK



22

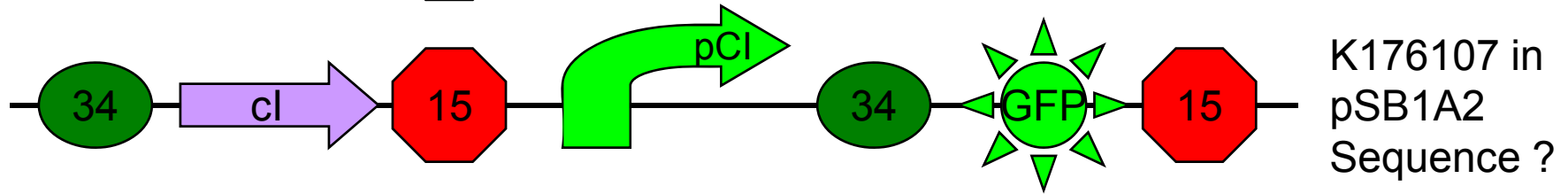
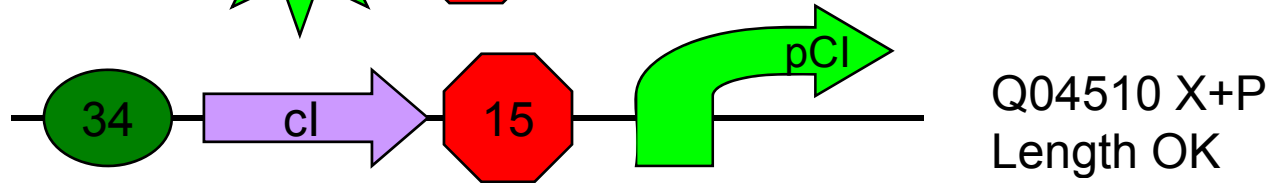
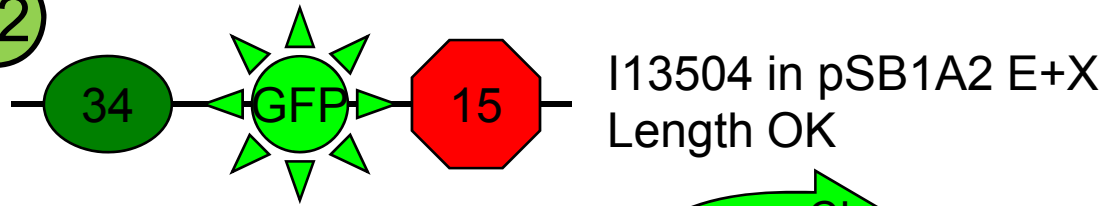

23

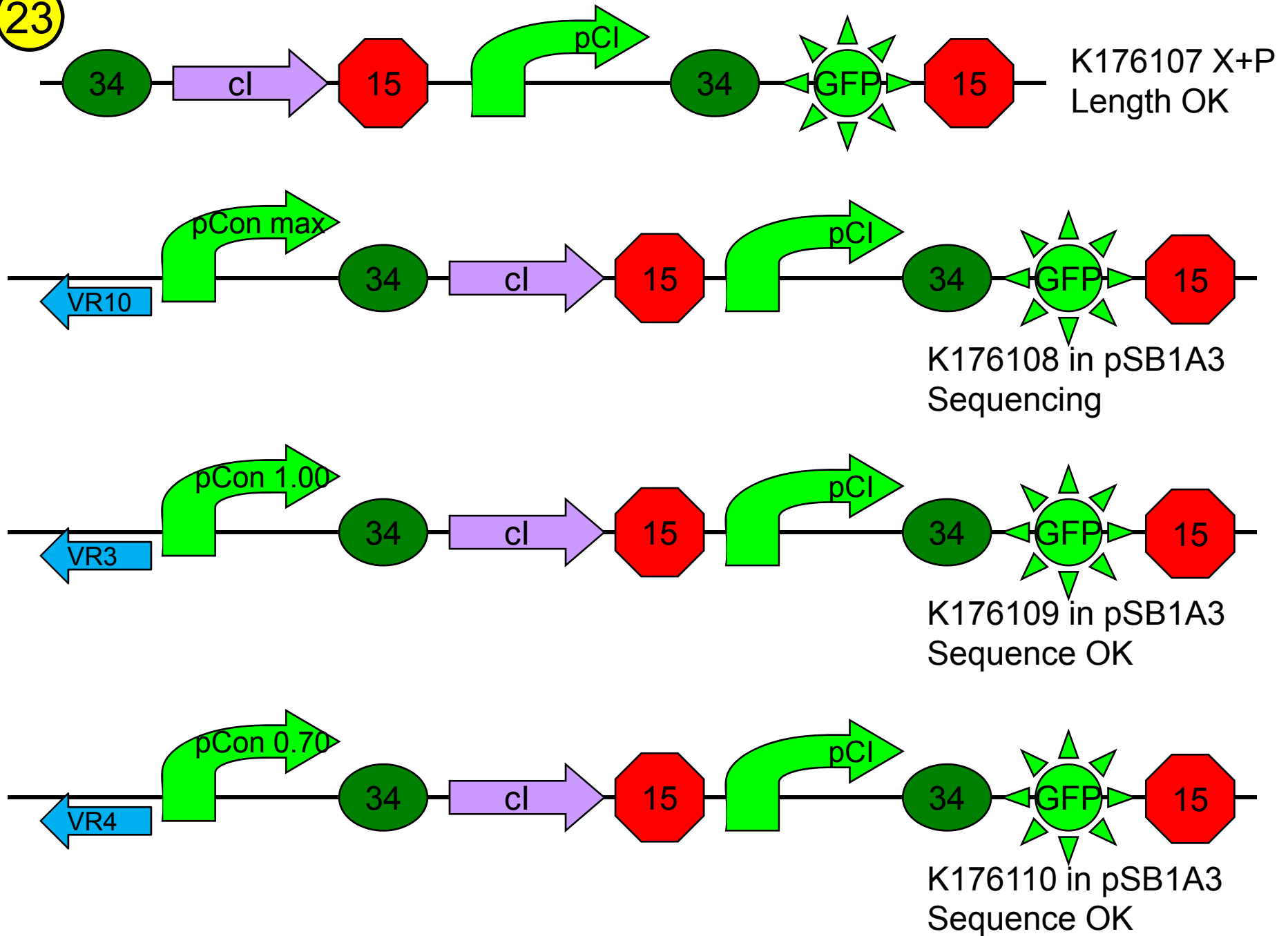

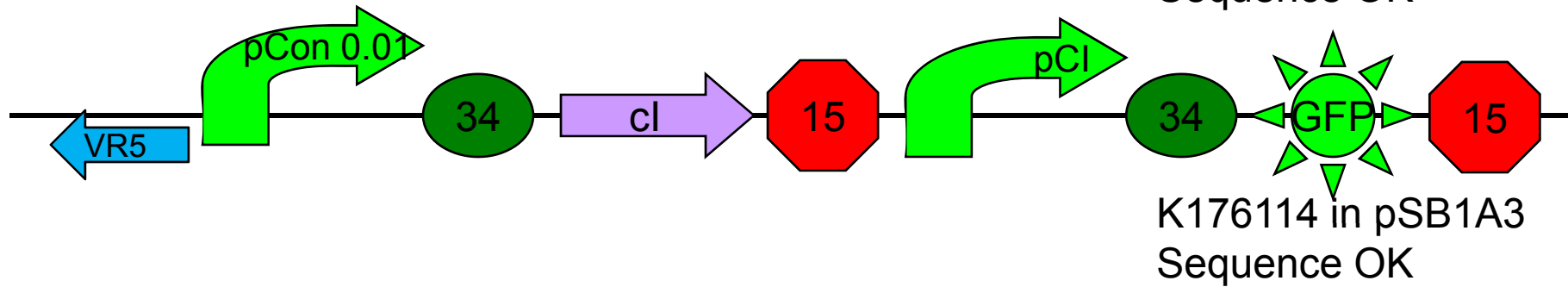
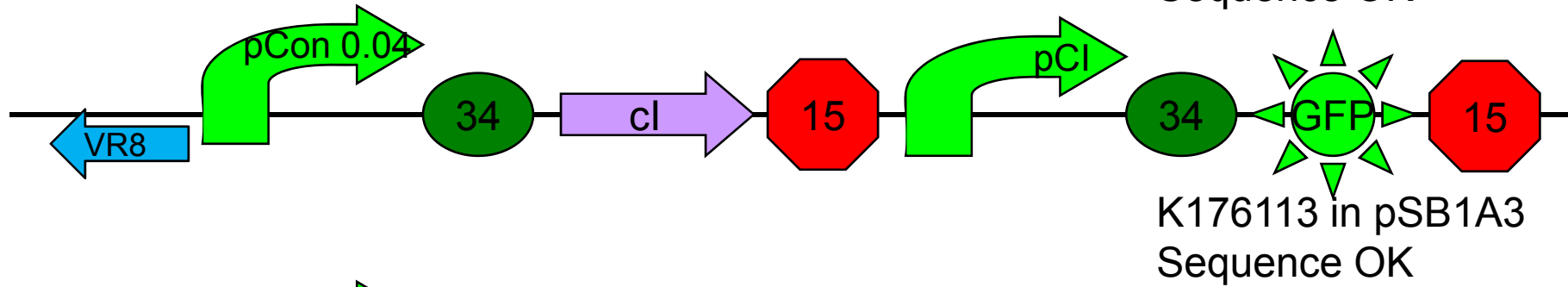
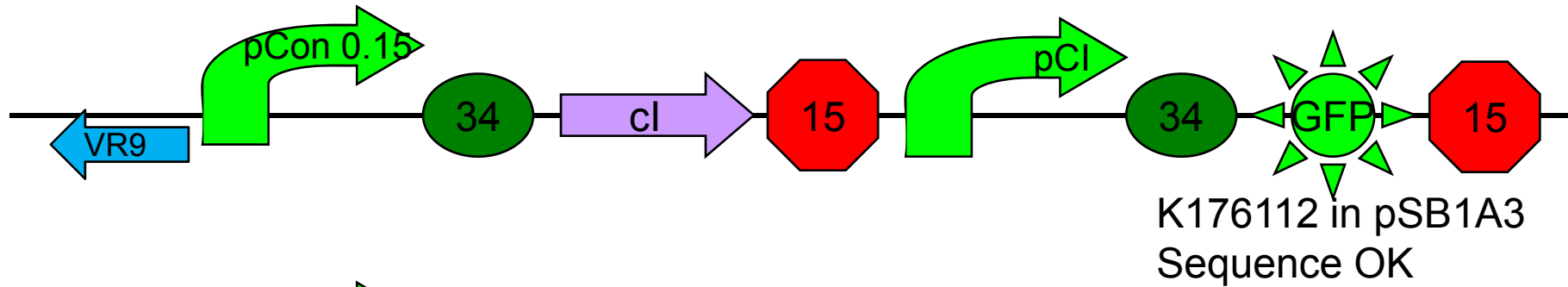
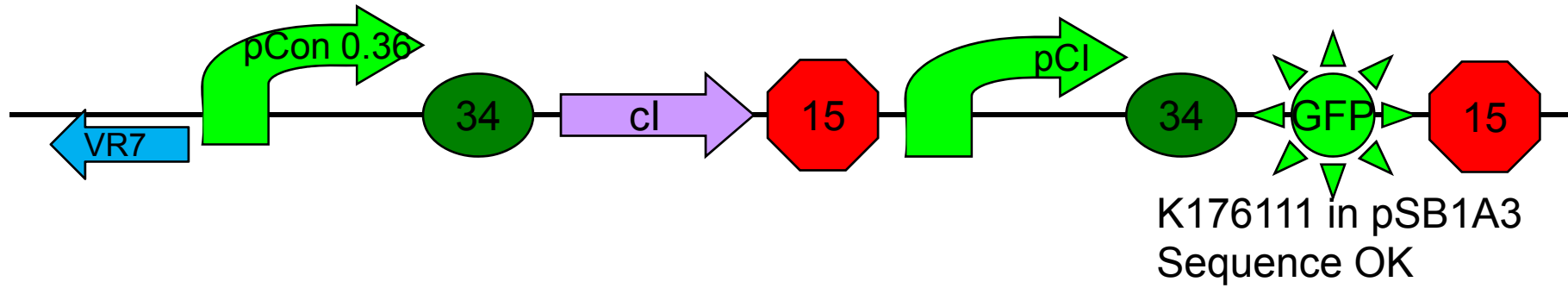

# MDS42 recA Blue

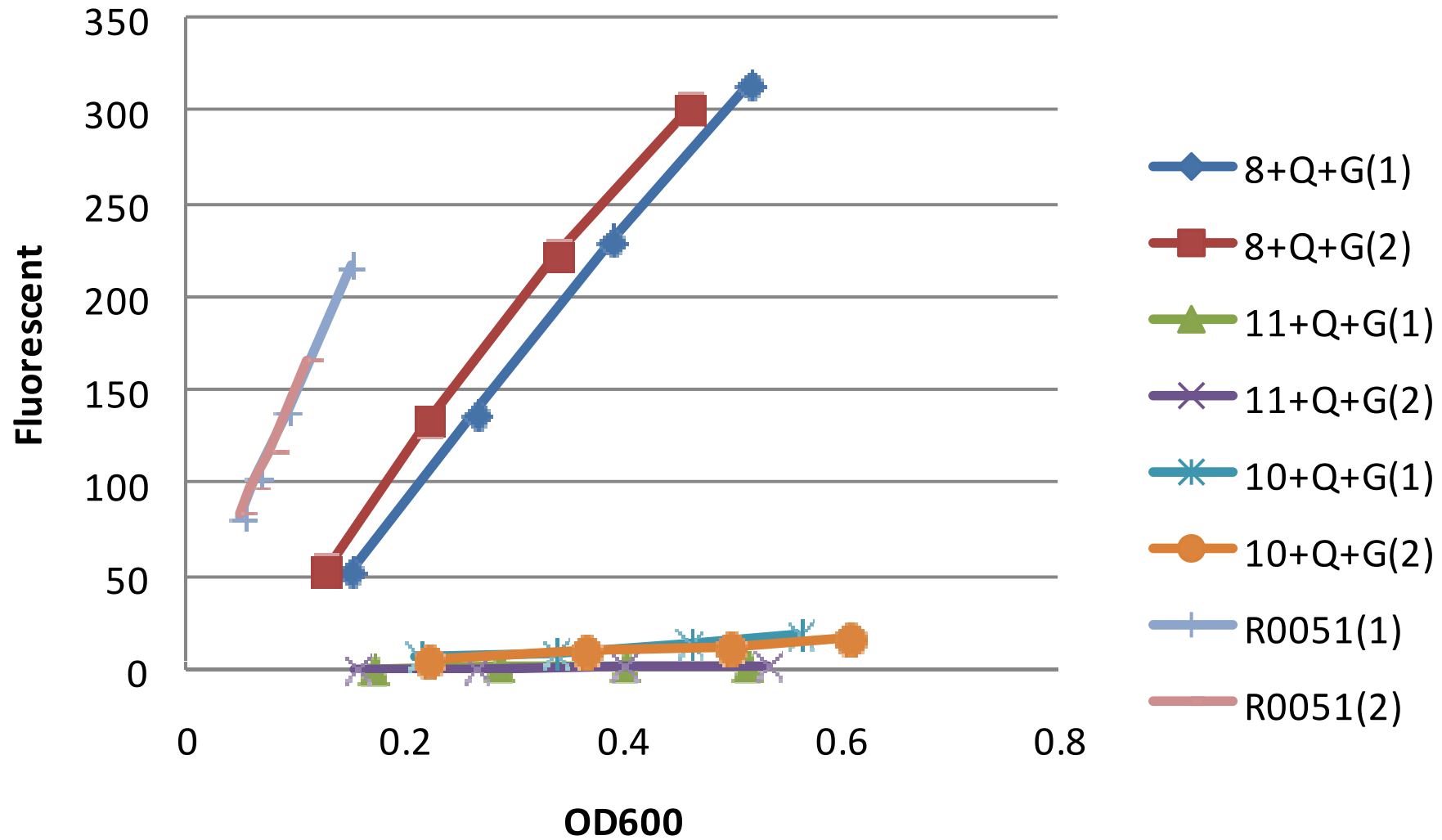

# Transfer Function

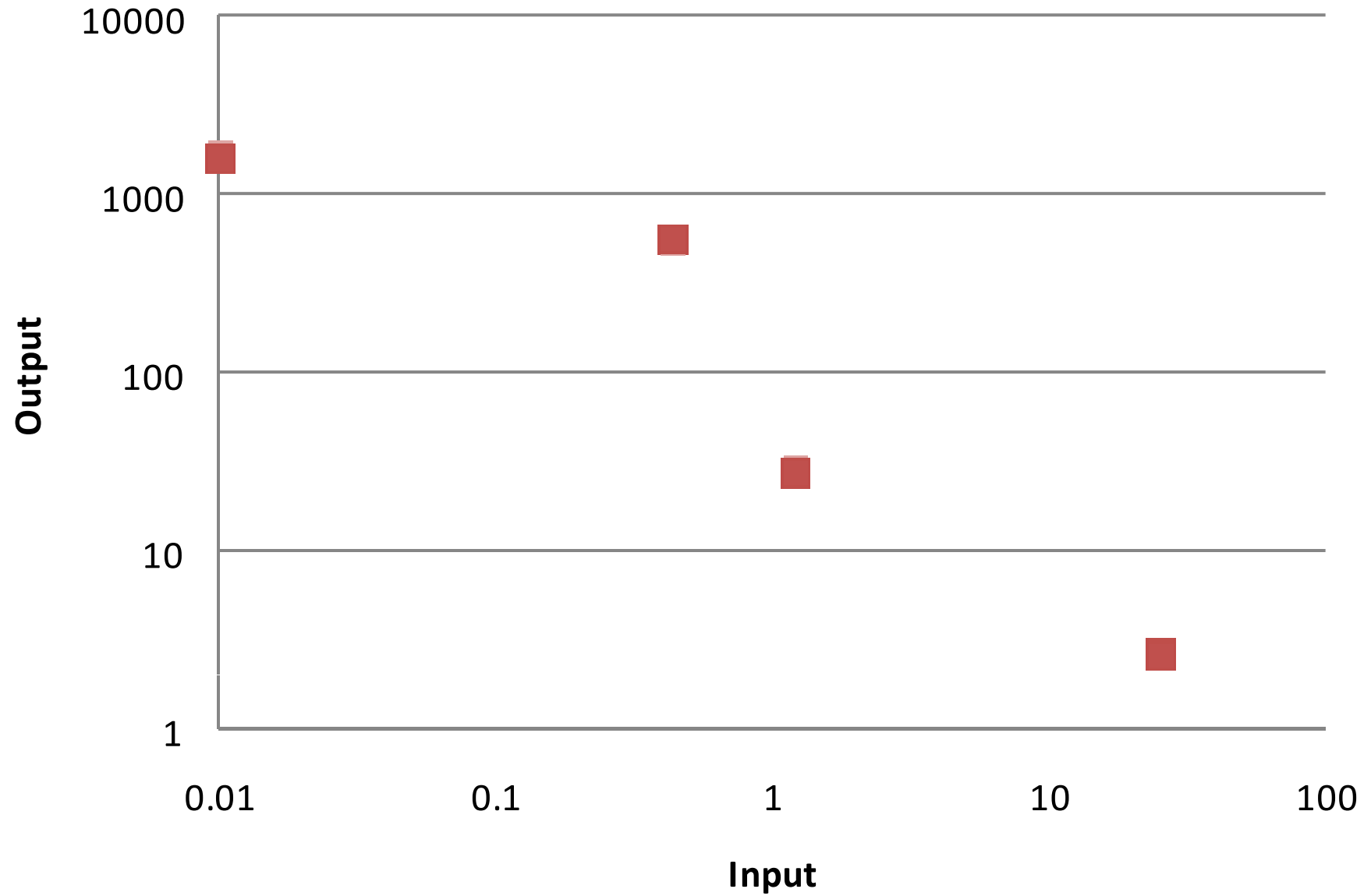

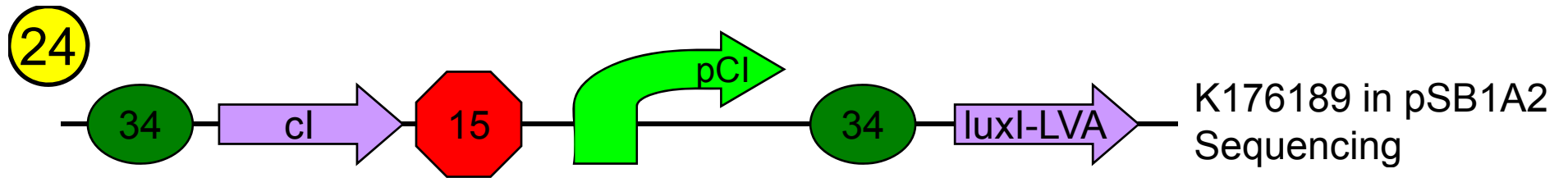

25



K103001 in pSB1A2  
Sequencing



K176190 fragment  
PCR



K176190 X+P  
Length OK



K176190 in pSB1A3  
Sequencing

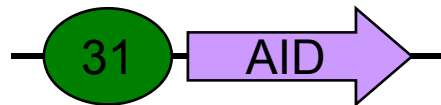

K176191 in pSB1A2  
Sequencing

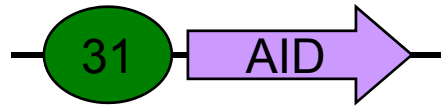

K176191 E+S  
Length OK

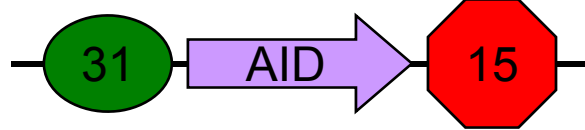

K176222 in pSB1AK3  
Sequencing

26

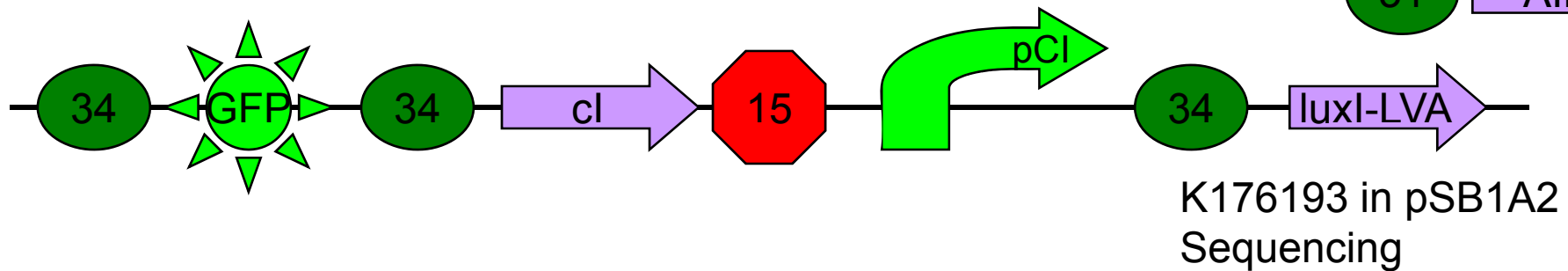
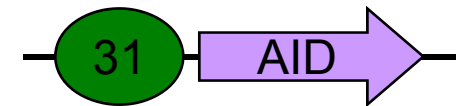
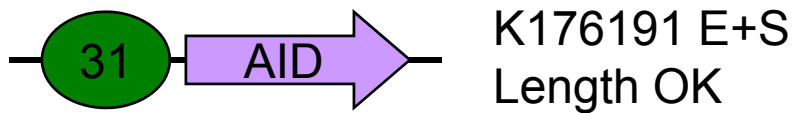
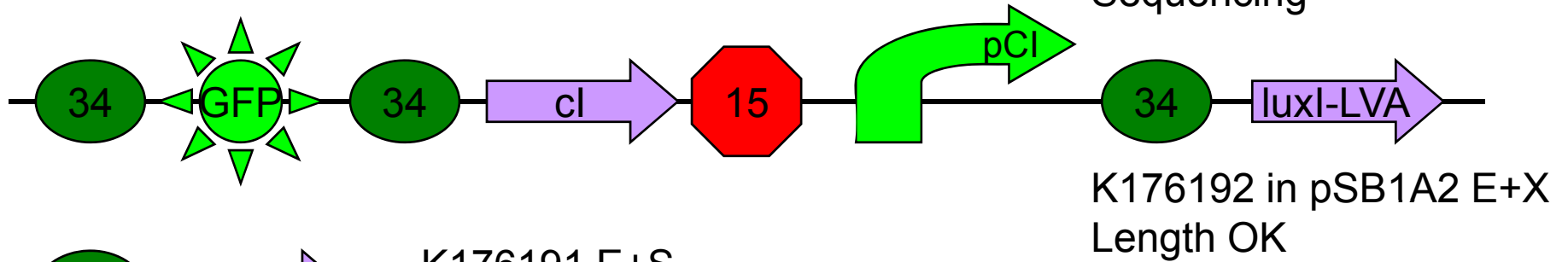
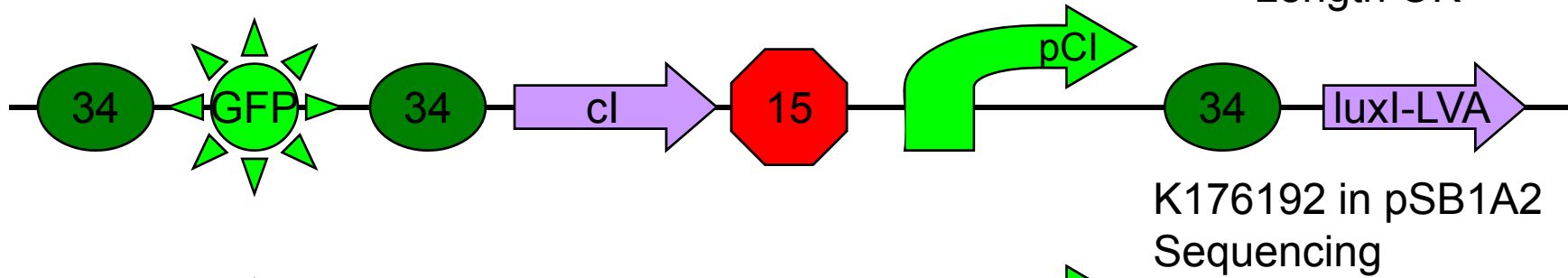
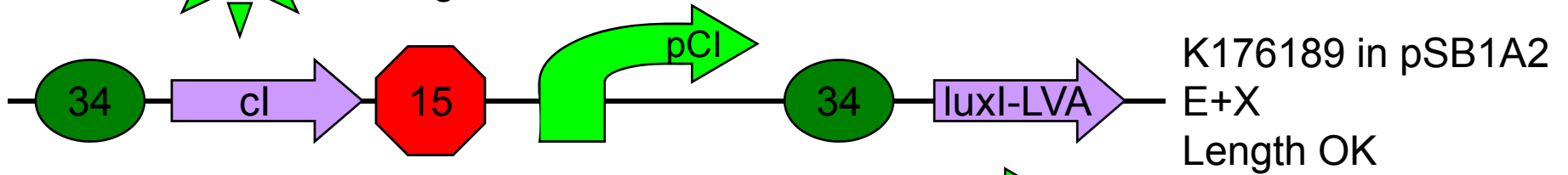
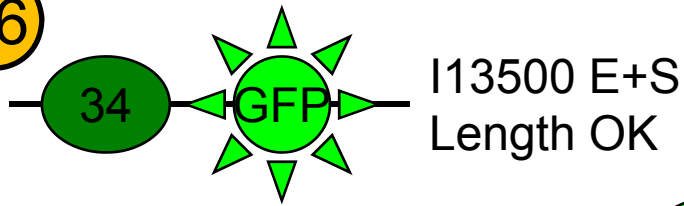



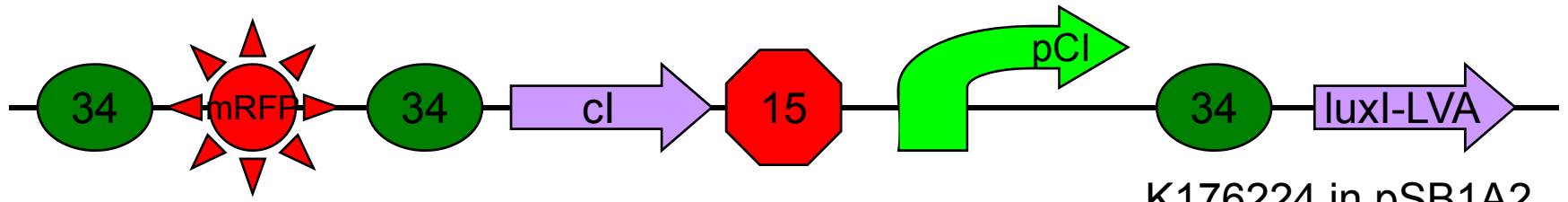

K176224 in pSB1A2  
Ligation

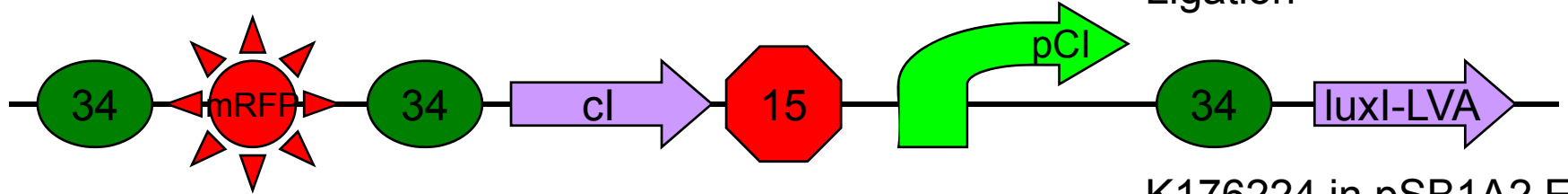

K176224 in pSB1A2 E+X  
Waiting

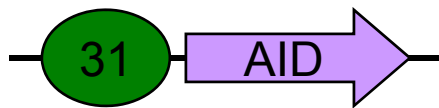

K176191 E+S  
Length OK

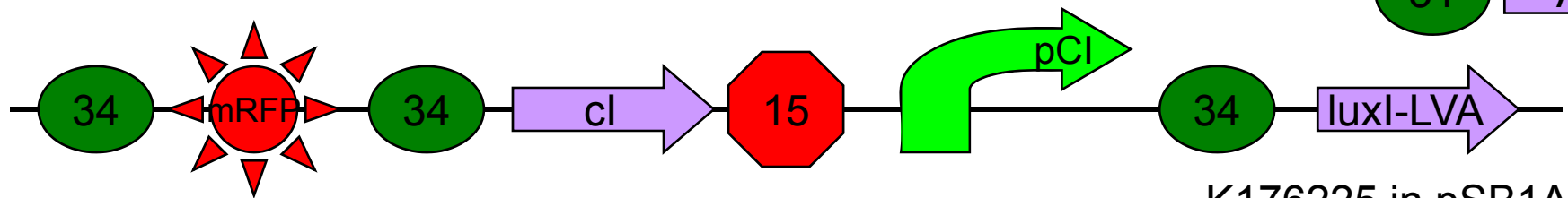
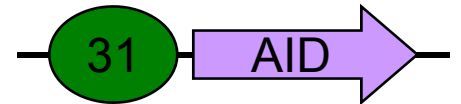

K176225 in pSB1A2  
Waiting





# Measurement

- Strain
  - TOP10
  - DH5 $\alpha$
  - MG1655
  - MDS 42 recA Blue
- Plasmid
- Medium
  - LB
  - M9
    - Minimal
    - Supplemented
  - EZ Rich Define
  - pH-buffered TBK
  - pH-buffered LBK
- pH
- Temperature
  - 37°C
  - 30°C
  - 34°C
- Pre-warm
- Shake
- Dilution
- Wash

# Wiki

- Team project description
- Notebook
  - Meetings
  - Lab Work
  - Sample Naming Sheets
- Logo
- Team
- Other pages

# NOTICE

## Visitor to USTC iGEM team

Prof. Fang

2009.9.20  
AM 9:00



化学工程与生物工程系

Department of Chemical  
and Biochemical Engineering

本系简介  
教师风采

教学动态

科研学术

学生活动  
资料下载

| 网站首页 | 本系简介 | 新闻通知 | 教学园地 | 师资队伍 | 招生信息 | 学术科研 | 学生活动 | 招聘信息 | 资料下载 | 精品课程

栏目导航 [网站首页](#)>>[师资队伍](#)>>[生物化工研究所](#) >>方柏山

发表日期: 2008年12月10日      编辑: cebe      有2291位朋友读过此文 【字体: 大 中 小】

### 方柏山



#### 方柏山

男，福建莆田人，1957年生于北京，工学博士，闽江学者特聘教授，博士生导师（招收生物化工专业博士后、工业催化专业博士生、生物化工和化学工程等专业硕士研究生）。

Thank You