

E.ADEM v0.0.5.3

2009.8.29

2009.5.3

117 days

2009.8.29

61 days

2009.10.30

Calendar of Events

IGEM 2009 Calendar of Events

Note: Dates in grey have not been finalized yet. Make sure to check the calendar periodically for any changes!

- 19 February** IGEM 2009 registration opens
- 31 March** IGEM 2008 registration closes; Team registration fee due
- 13 May** DNA Distribution sent to teams (**target deadline; subject to change**)
- 16/17 May** [iGEM Workshop, MIT, USA](#)
- 1 June** [Visa invitation letter](#) requests due
- 20/21 June** [iGEM Workshop, Europe](#)
- 27/28 June** [iGEM Workshop, Asia](#)
- 15 June** Preliminary team rosters due
- 1 August** Team project descriptions due
- 18 September** [Jamboree attendance fee](#) due
- 18 September** [Request for variance](#) due (notice and description of any use of non-standard parts or devices schemes due)
 - [Track selection](#) due
 - [Project abstracts](#) due
 - [Team rosters](#) due
- 21 October** Project and part documentation due, including documentation for all medal criteria
 - BioBrick Part DNA needs to be received by the Registry
 - [Judging form](#) due
 - Wiki FREEZE at 11:59pm, EST
- 30 Oct - 2 Nov** iGEM Competition Jamboree, MIT, USA

Outline

- Assembly
- Measurement
 - General Conditions
 - GFP
 - AHL
 - CcdB
 - LacZ α
- Wiki
 - Team project description
 - Notebook
- Instructional Videos

Assembly

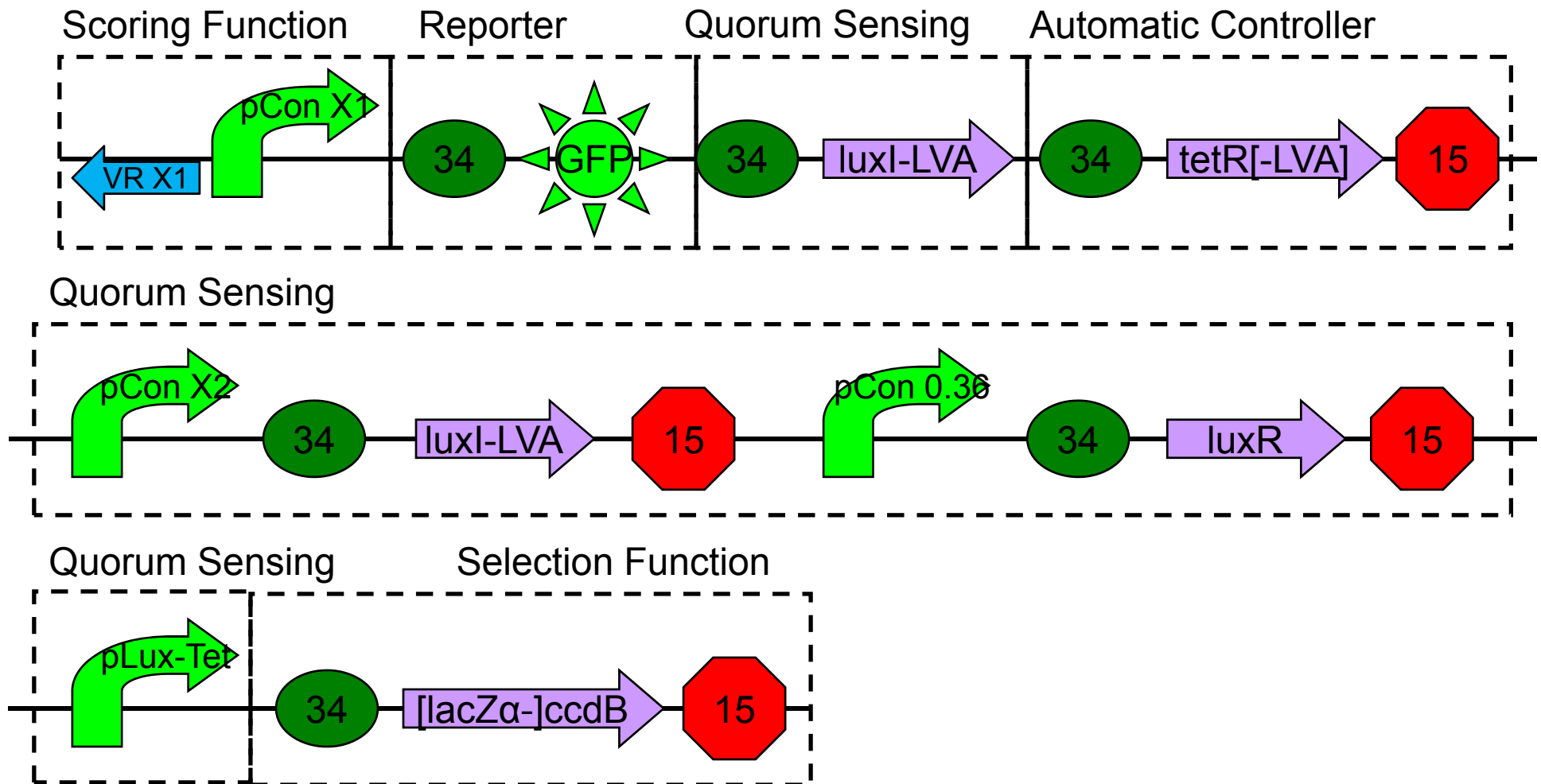

1. pLux-Tet
2. pLux-Tet + GFP
3. pCon + luxR × 4 + pLux-Tet
4. ccdB × 4

Waiting
Working
Done
Sequenced

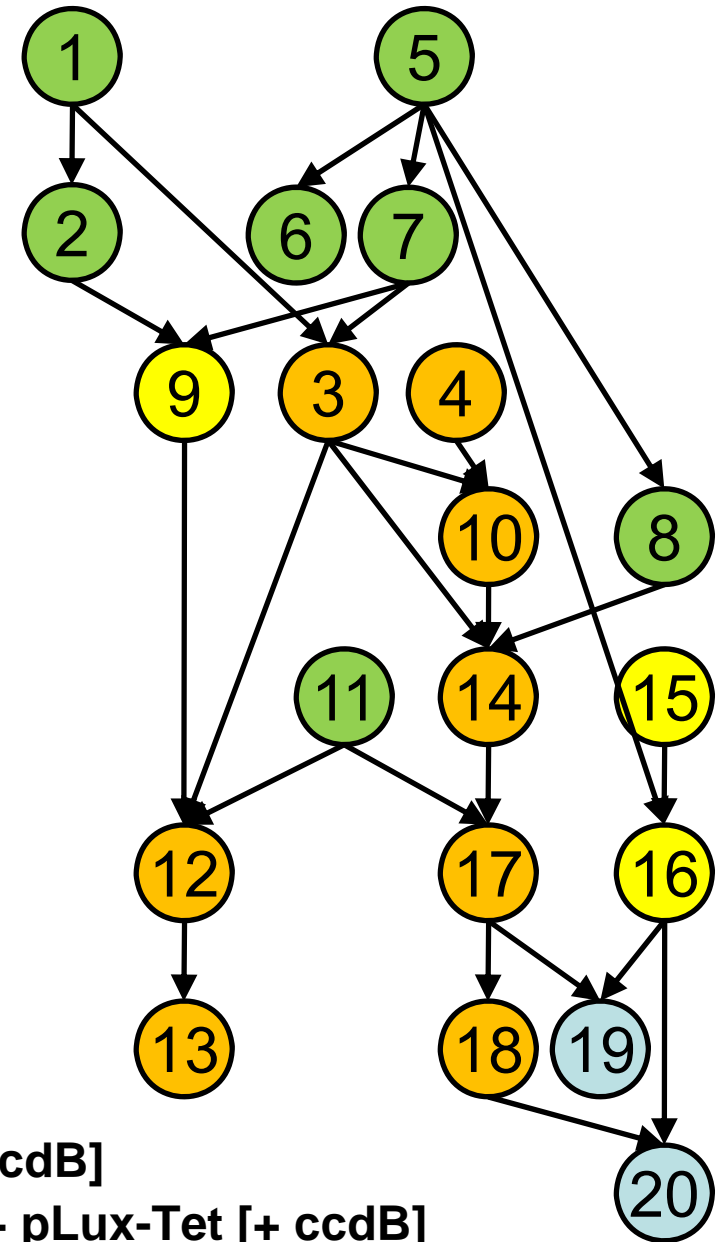

5. pCon × 8

6. pCon × 8 + GFP

7. pCon + luxR

8. pCon × 7 + luxI (AHL detection by 9)

9. pCon + luxR × 4 + pLux-Tet + GFP (AHL)

10. pCon + luxR × 4 + pLux-Tet + ccdB × 4 (AHL)

11. tetR × 2

12. tetR × 2 + pCon × 2 + luxR + pLux-Tet [+ GFP]

13. pCon × 4 + tetR × 2 + pCon × 2 + luxR + pLux-Tet
[+ GFP] (AHL/aTc)

14. [pCon × 7 +] luxI + pCon × 2 + luxR + pLux-Tet
[+ ccdB × 2]

15. VR × 10

16. (VR + pCon) × 7

17. tetR + pCon + luxI + pCon + luxR + pLux-Tet [+ ccdB]

18. [GFP +] luxI + tetR + pCon + luxI + pCon + luxR + pLux-Tet [+ ccdB]

19. (VR + pCon) × 6 + tetR + pCon + luxI + pCon + luxR + pLux-Tet [+ ccdB]

20. (VR + pCon) × 6 + GFP + luxI + tetR + pCon + luxI + pCon + luxR + pLux-Tet [+ ccdB]

Evolution Object

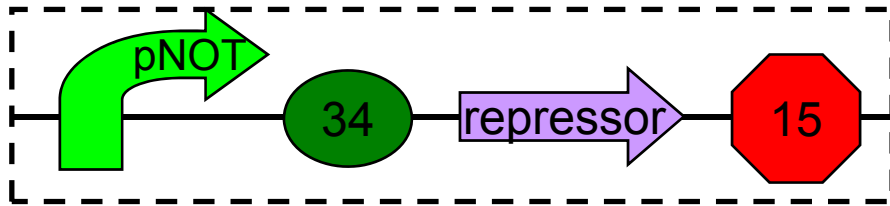

Scoring Function

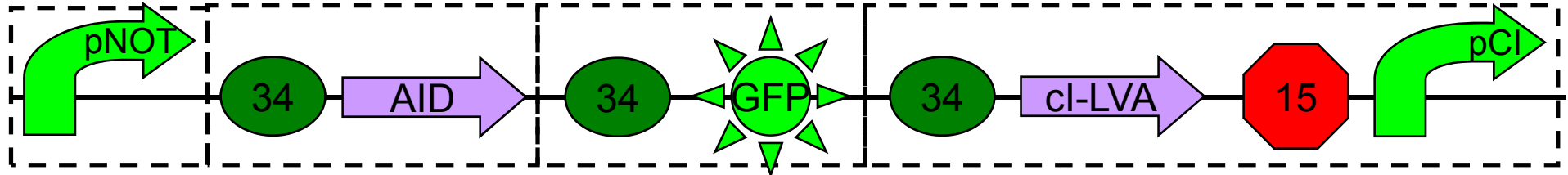

Quorum Sensing

Automatic Controller

Quorum Sensing

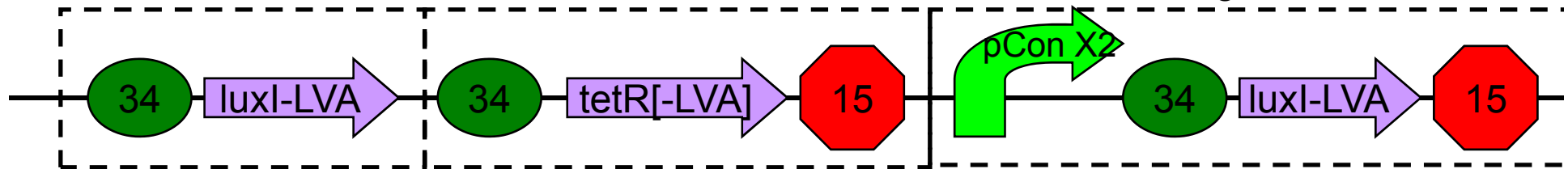

Quorum Sensing

Selection Function

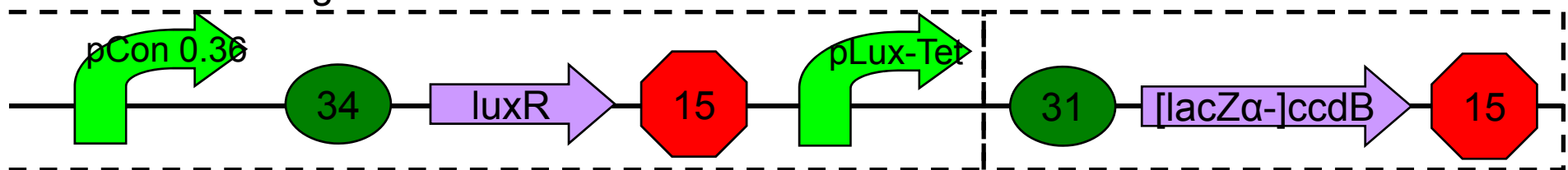

- 21. *cl* + p*Cl*
- 22. *cl* + p*Cl* + GFP
- 23. (VR + pCon) × 7 + *cl* + p*Cl* + GFP
- 24. *cl* + p*Cl* + *luxI* + *tetR* + pCon + *luxI* + pCon + *luxR* + pLux-Tet [+ *ccdB*]
- 25. AID
- 26. [AID +] GFP + *cl* + p*Cl* + *luxI* + *tetR* + pCon + *luxI* + pCon + *luxR* + pLux-Tet [+ *ccdB*]
- 27. (VR + pCon) × 7 + GFP + *cl* + p*Cl* + *luxI* + *tetR* + pCon + *luxI* + pCon + *luxR* + pLux-Tet [+ *ccdB*]
- 28. pNOT
- 29. pNOT + GFP
- 30. pNOT + [AID +] GFP + *cl* + p*Cl* + *luxI* + *tetR* + pCon + *luxI* + pCon + *luxR* + pLux-Tet [+ *ccdB*]
- 31. repressor
- 32. pNOT + repressor

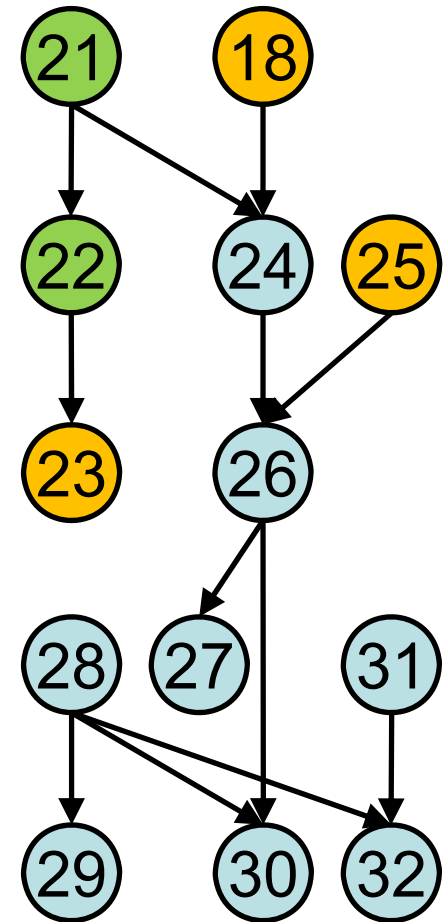

1

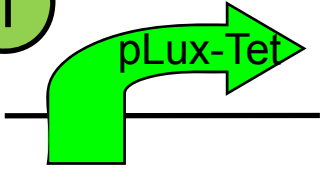

K176000 X+P with nicks
Sequence OK



G00100
Synthesis OK



G00101
Synthesis OK

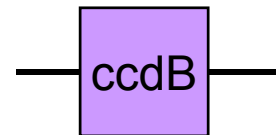

P1010 in pSB1A3 in DB 3.1
Length OK



pSB1A3 X+P
Length OK

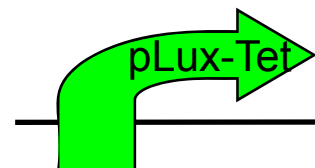

K176000 in pSB1A3
Sequence OK

2

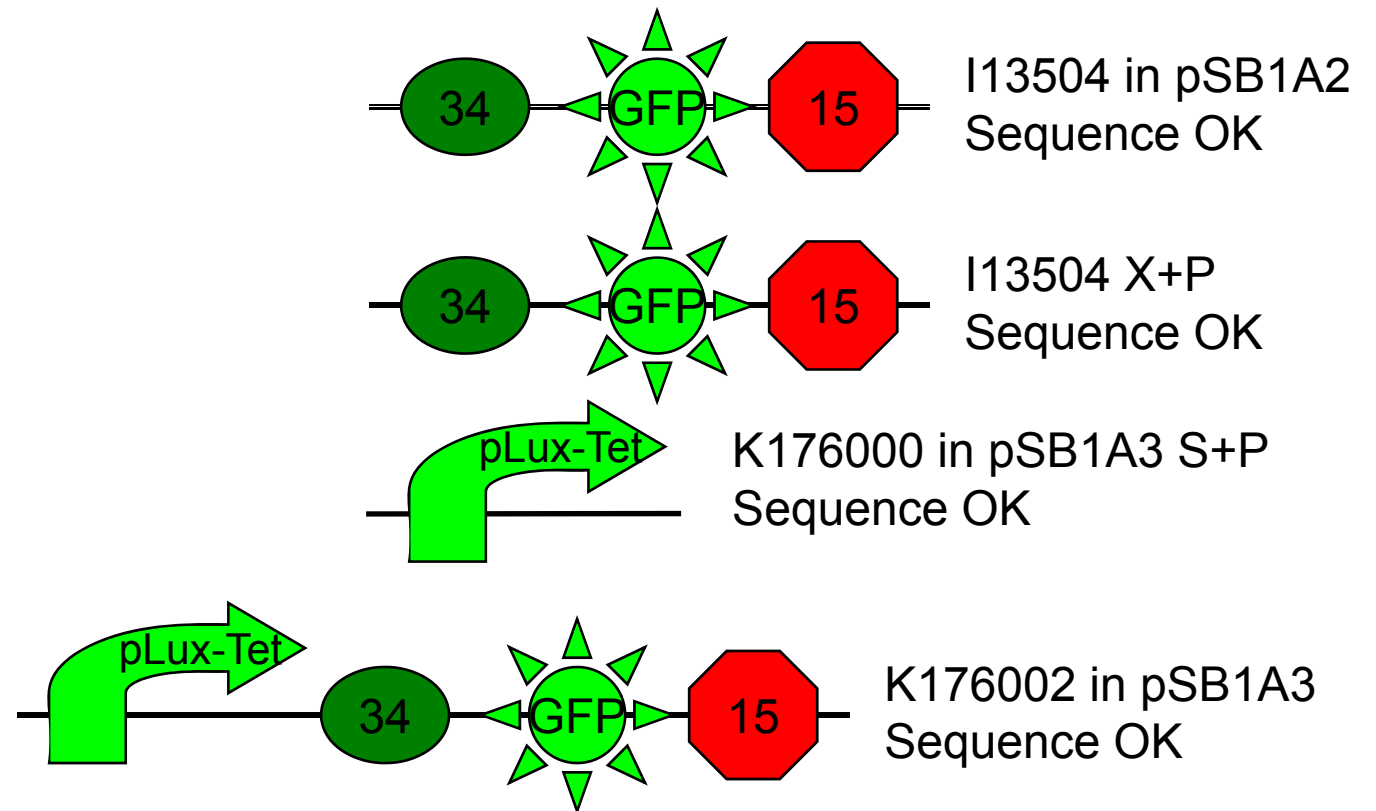

4



K145151 in pSB1A2 in DB3.1

Sequence OK

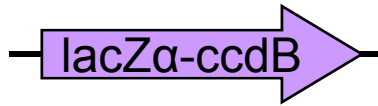

K176003 Fragment Length OK



B0034 in pSB1A2 Sequence OK



B0034 in pSB1A2 S+P Length OK

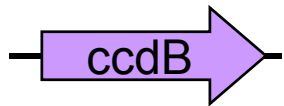

K145151 X+P Length OK

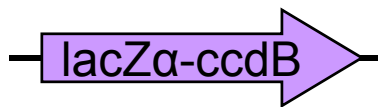

K176003 X+P Length OK

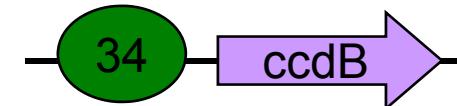

K176010 in pSB1A2 in DB3.1 Ligation

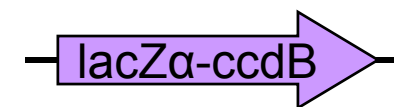

K176003 in pSB1A3 in DB3.1 Sequence OK

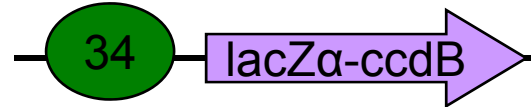

K176027 in pSB1A2 in DB3.1 Sequence OK

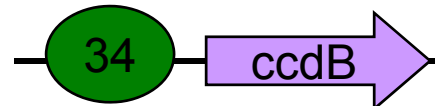

K176010 E+S Length OK

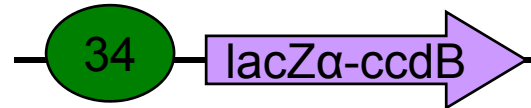

K176027 E+S Length OK

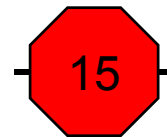

B0015 in pSB1AK3 Sequence OK



B0031 in pSB1A2 Length OK



B0031 S+P Length OK

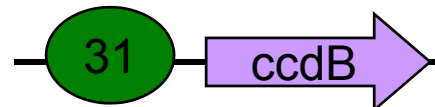

K176060 in pSB1A2 in DB3.1 Sequence OK

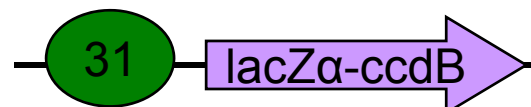

K176061 in pSB1A2 in DB3.1 Sequence OK

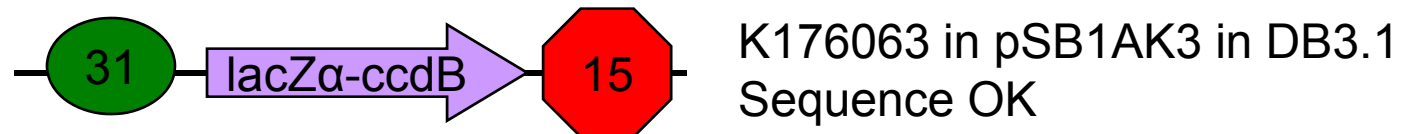
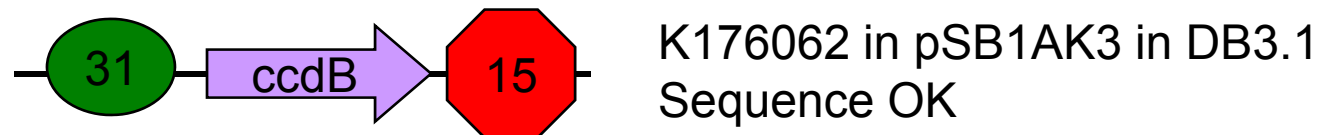
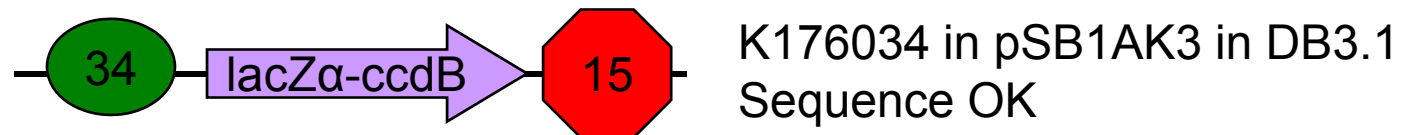
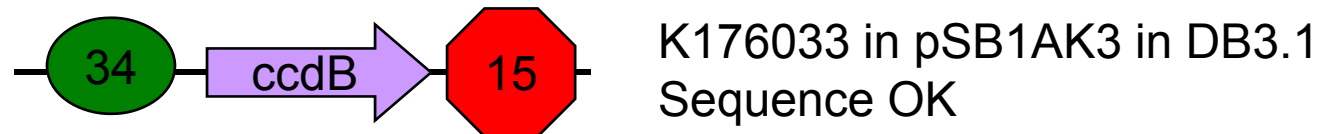
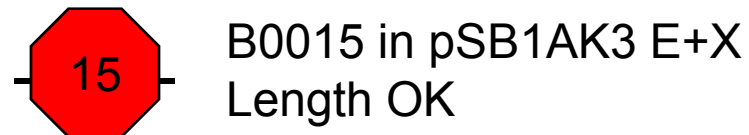
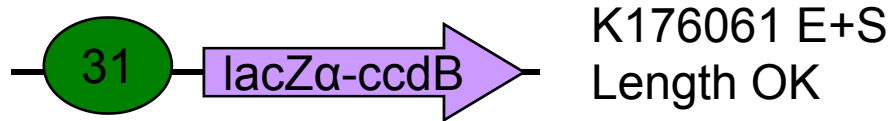
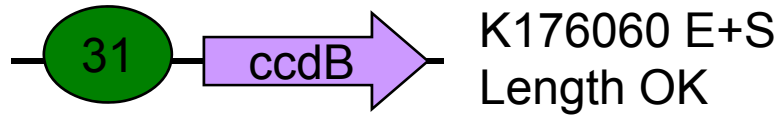

5

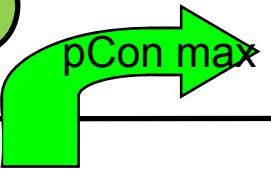
 J23119 in pSB1A2
Sequence OK

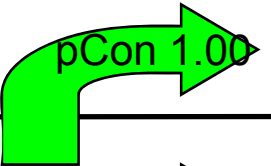
 J23100 in J61002
Sequence ?

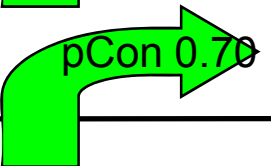
 J23101 in J61002
Sequence OK

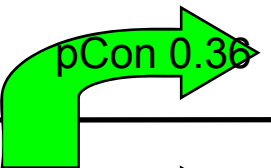
 K176009 in J61002
Sequence OK

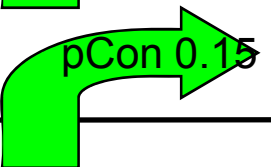
 K176008 in J61002
Sequence OK

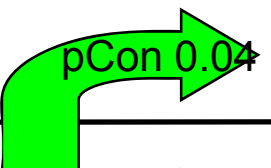
 J23109 in J61002
Sequence OK

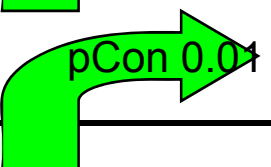
 J23103 in J61002
Sequence OK

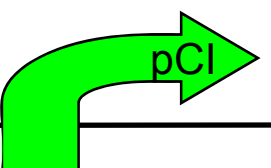
 R0051 in pSB1A2
Sequence OK

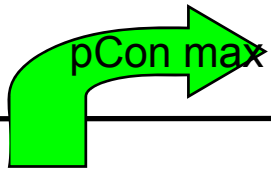
 J23119 X+P
Sequence OK

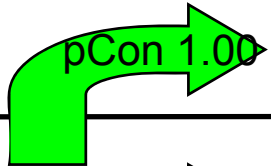
 J23100-J61002SF X+P
Sequence ?

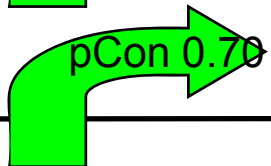
 J23101-J61002SF X+P
Sequence OK

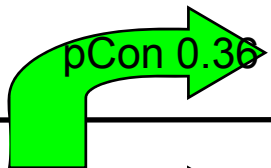
 K176009-J61002SF X+P
Sequence OK

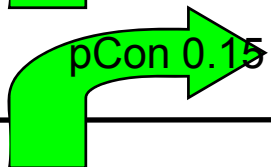
 K176008-J61002SF X+P
Sequence OK

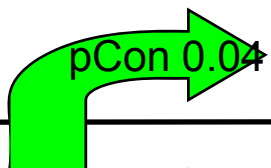
 J23109-J61002SF X+P
Sequence OK

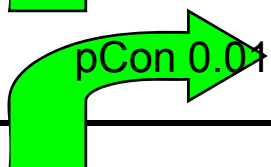
 J23103-J61002SF X+P
Sequence OK

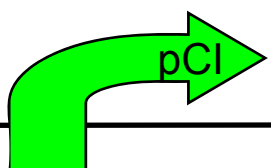
 R0051 X+P
Length OK

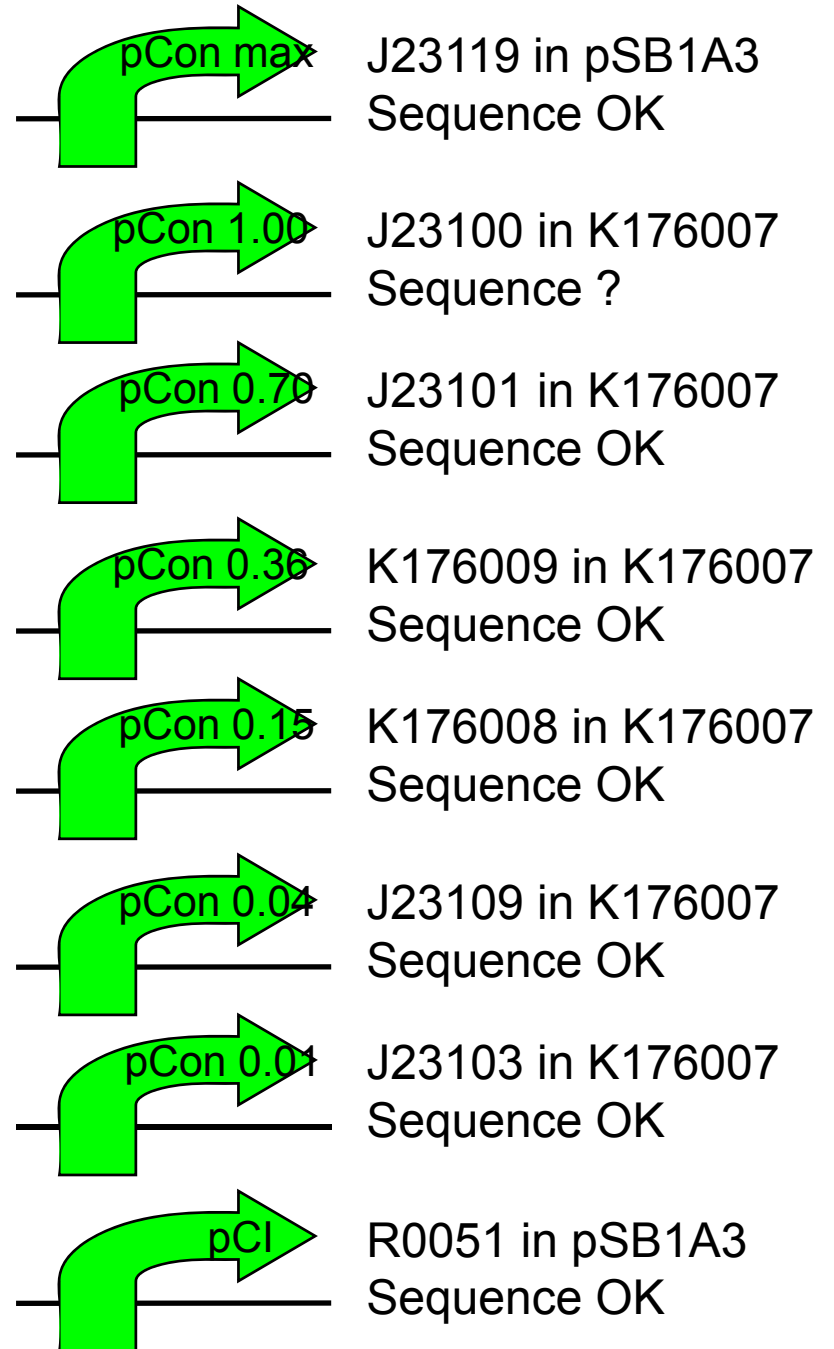

6

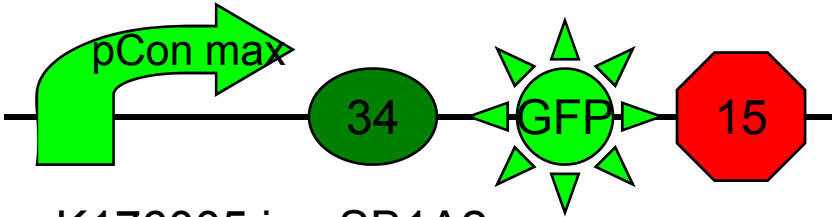
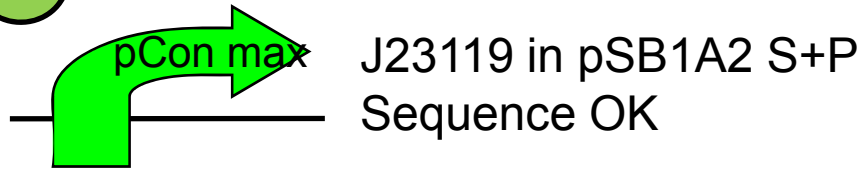

K176005 in pSB1A2
Sequence OK

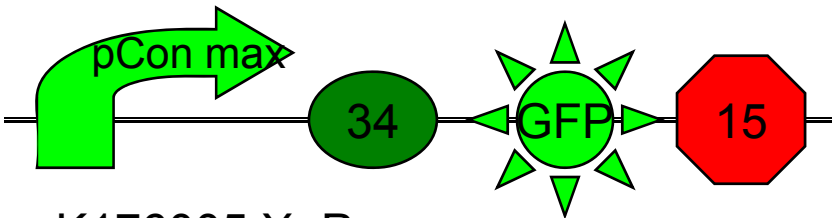

K176005 X+P
Length OK

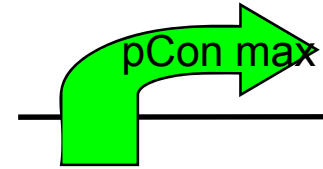

J23119 in pSB1A3 S+P
Length OK

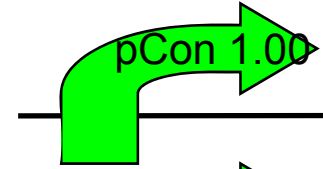

J23100 in pSB1A3 S+P
Length OK

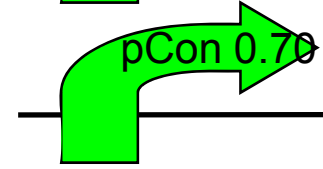

J23101 in pSB1A3 S+P
Length OK

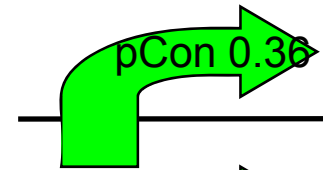

K176009 in pSB1A3 S+P
Length OK

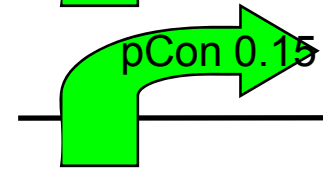

K176008 in pSB1A3 S+P
Length OK

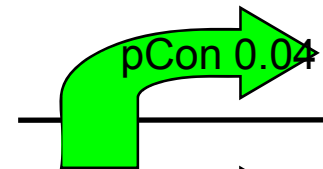

J23109 in pSB1A3 S+P
Length OK

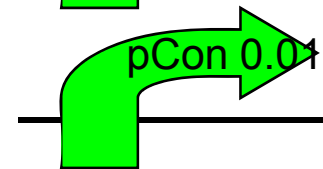

J23103 in pSB1A3 S+P
Length OK

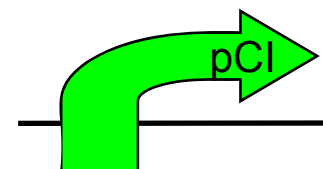

R0051 in pSB1A3 S+P
Length OK

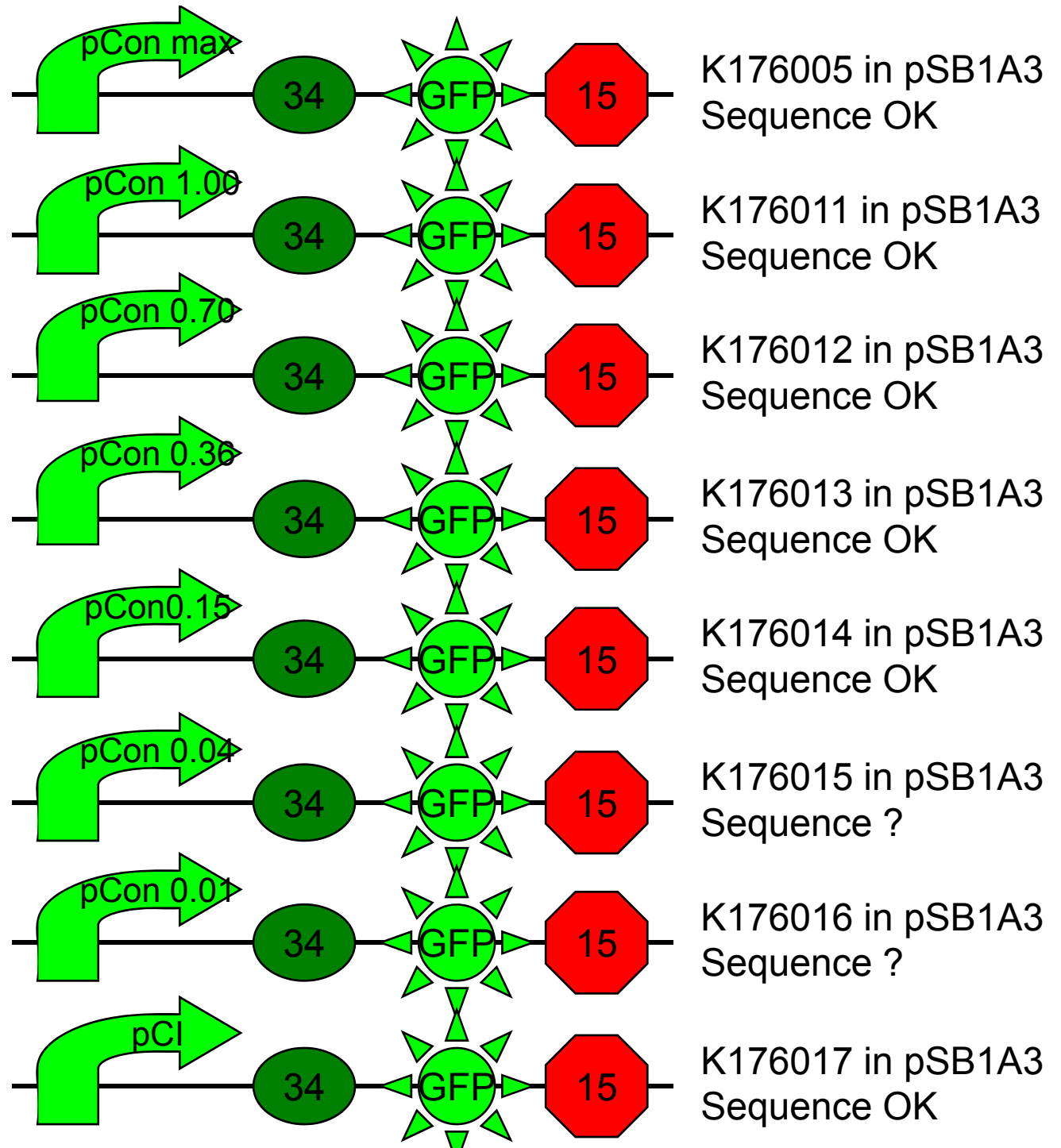

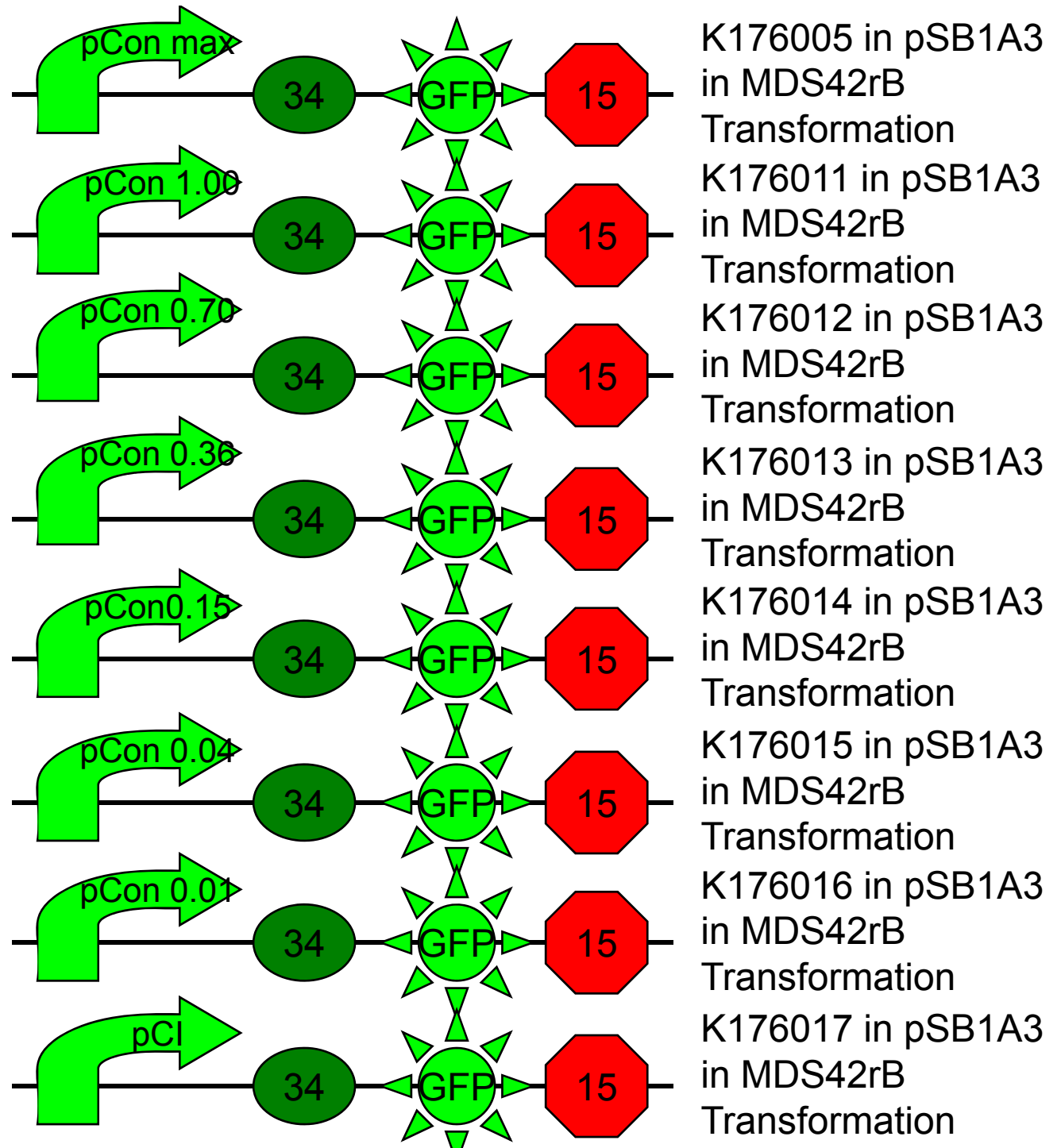

Flu:OD

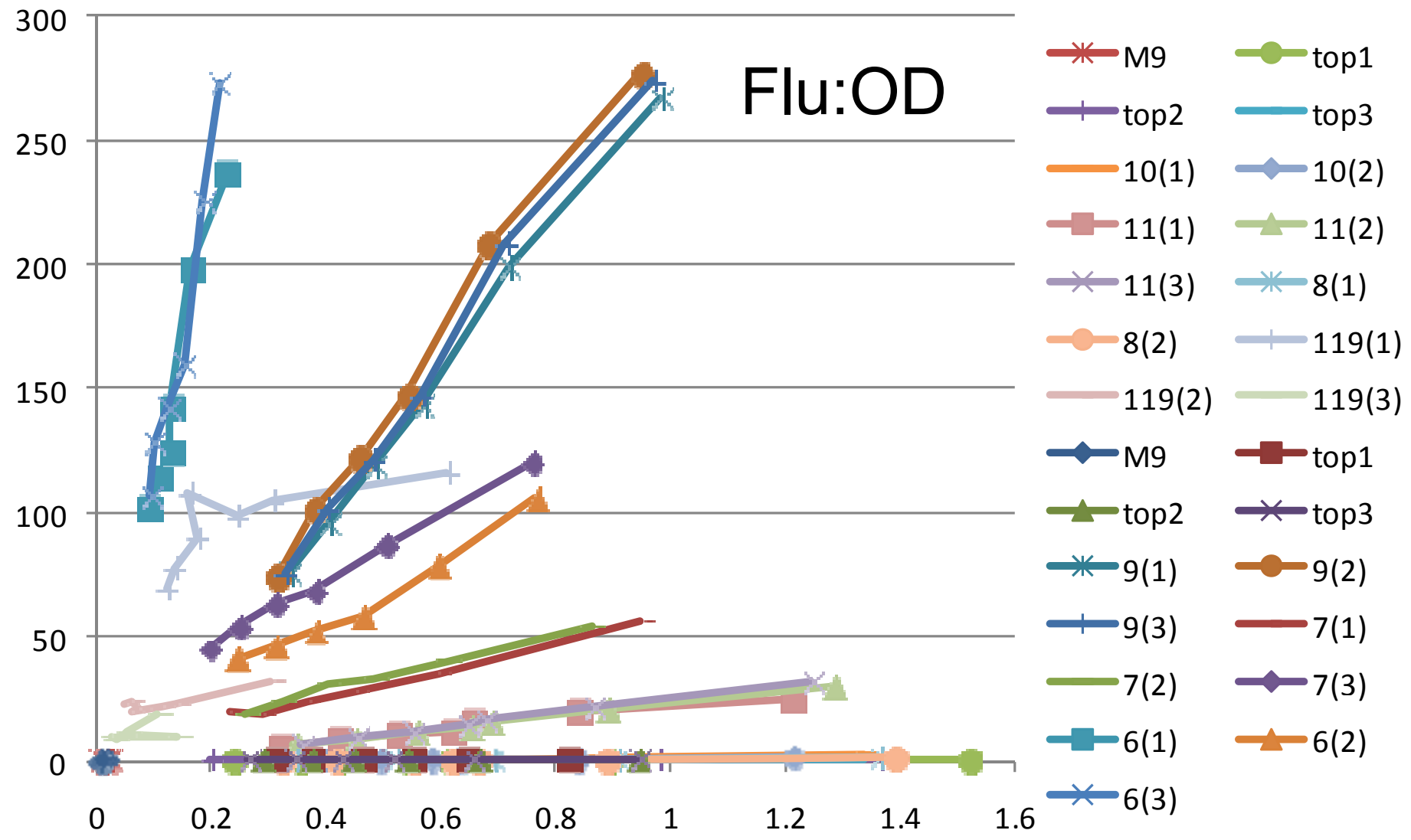

Flu:OD

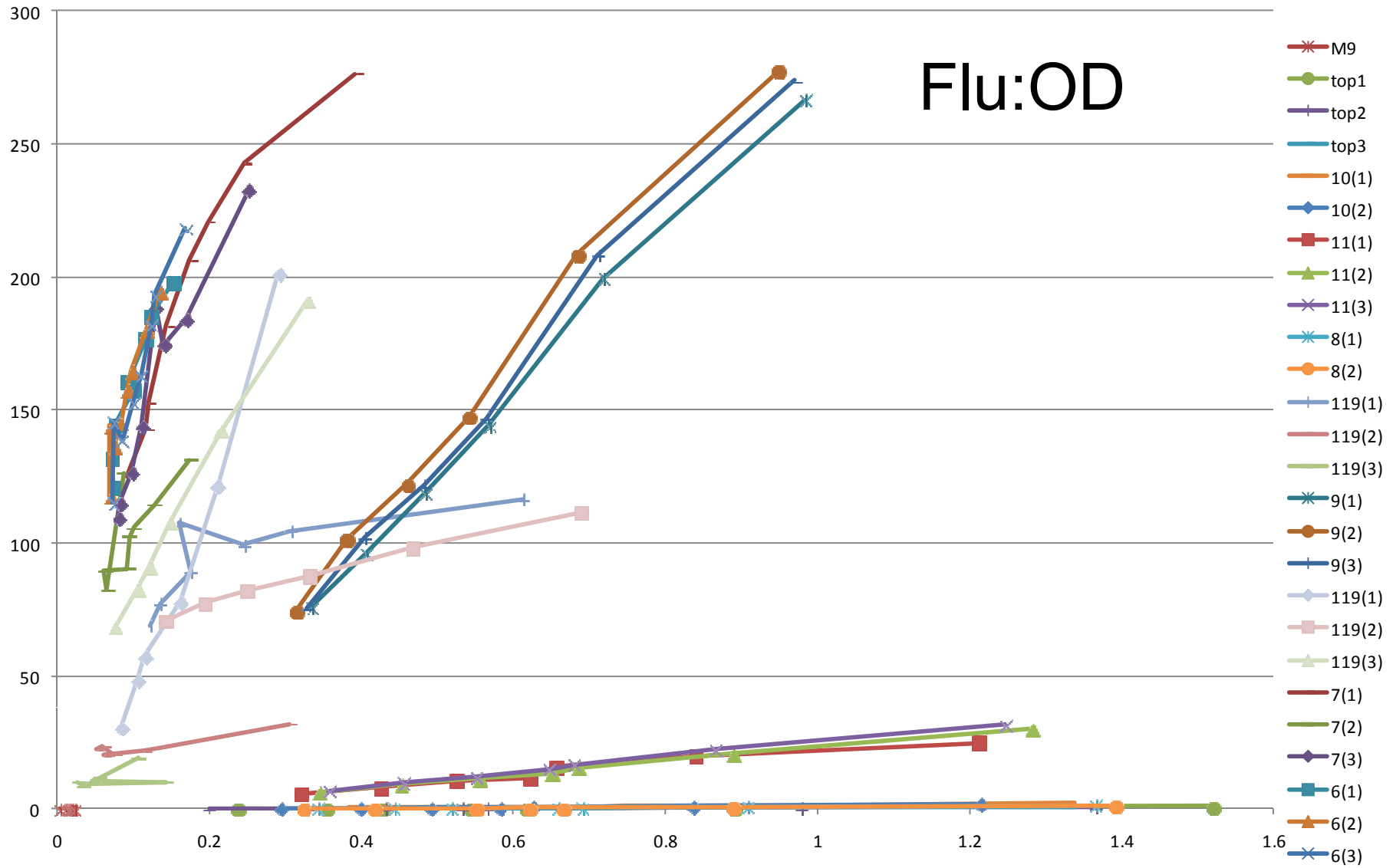

7

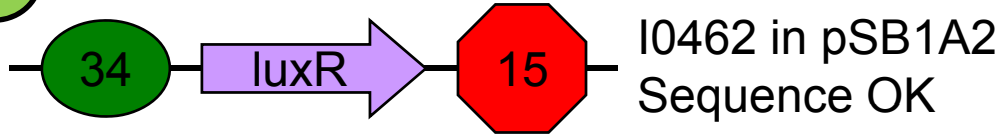

I0462 in pSB1A2
Sequence OK

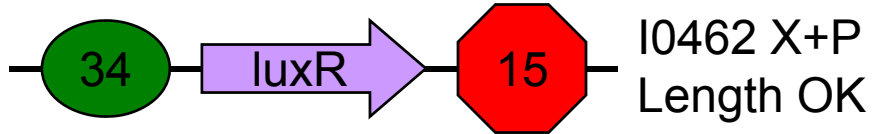

I0462 X+P
Length OK

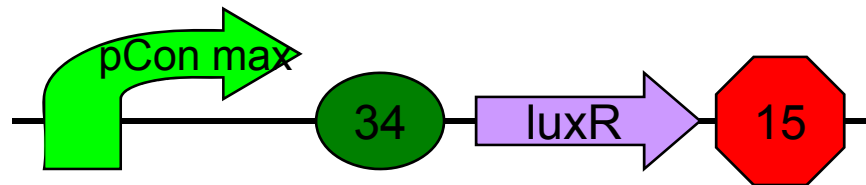

K176004 in pSB1A2
Sequence OK
Length ?

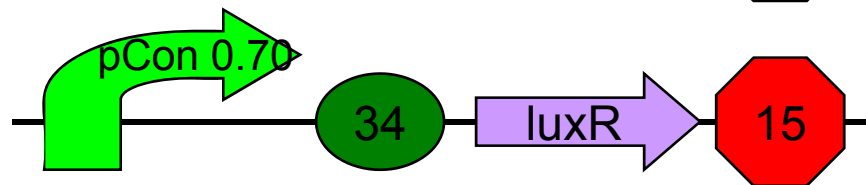

K176025 in pSB1A3
Sequence ?

8

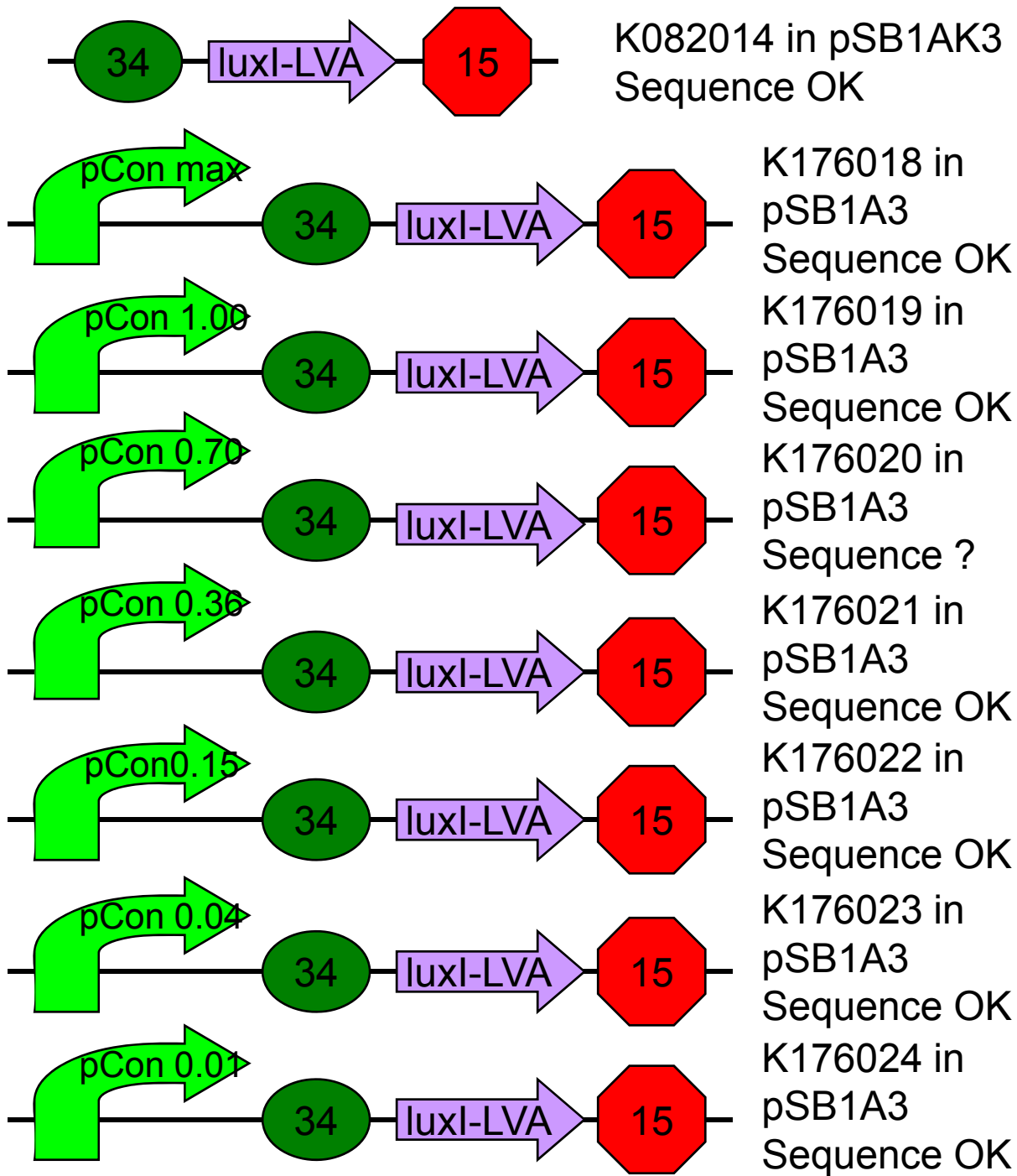

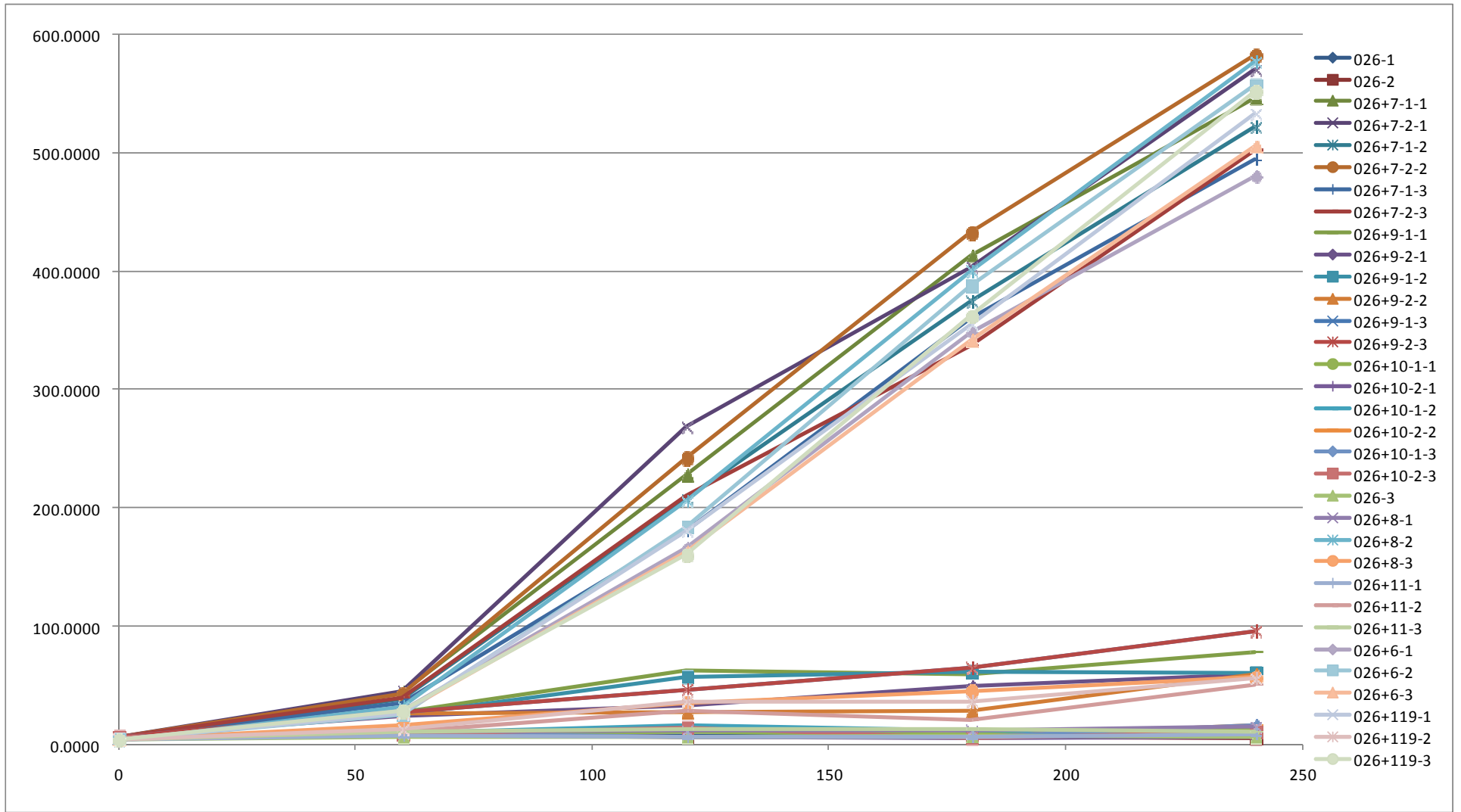

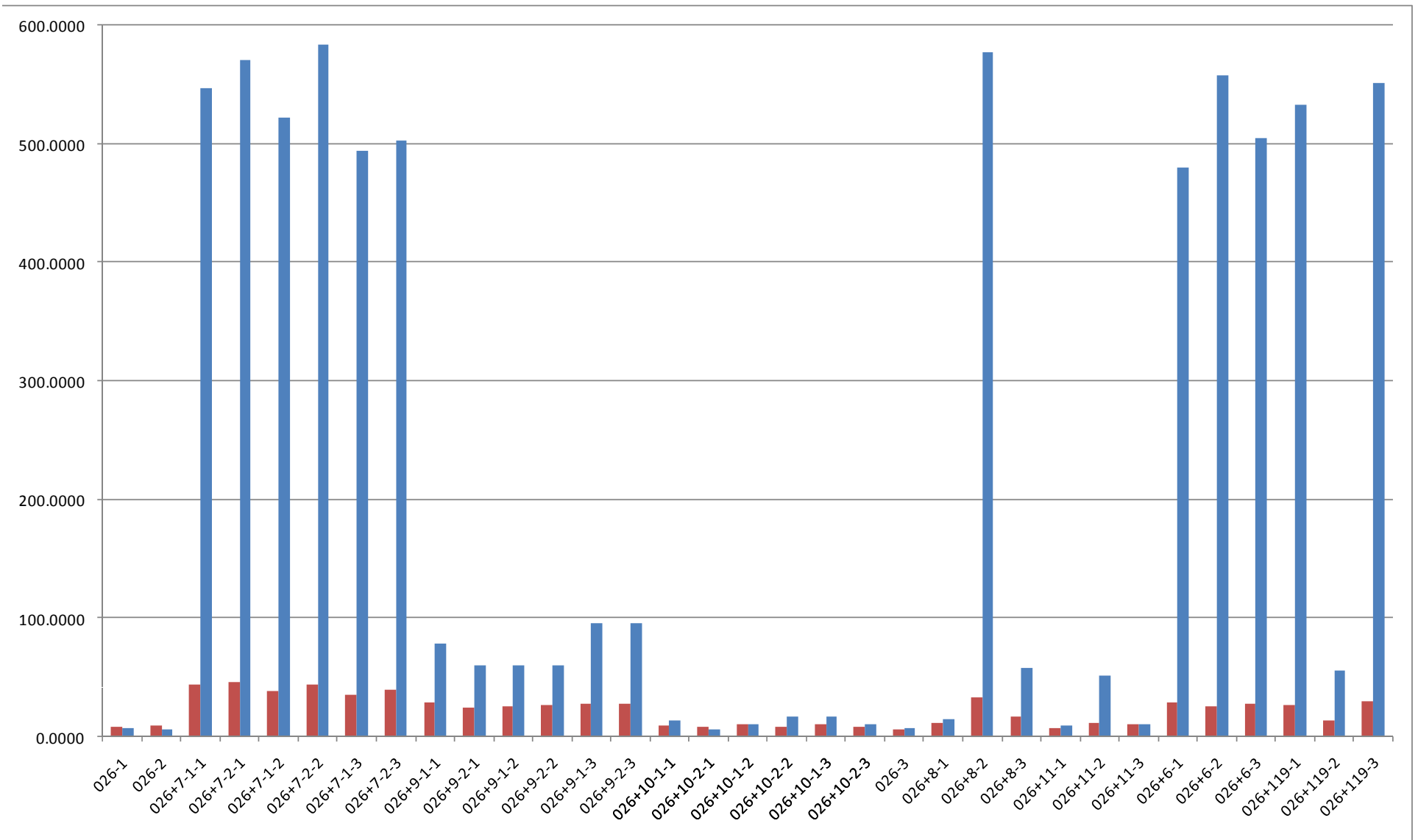

3

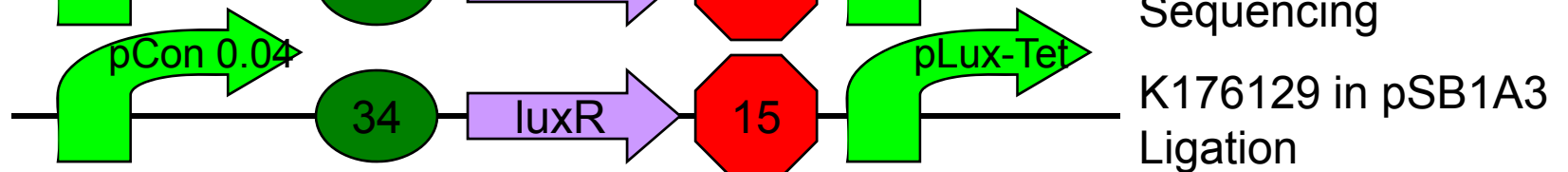
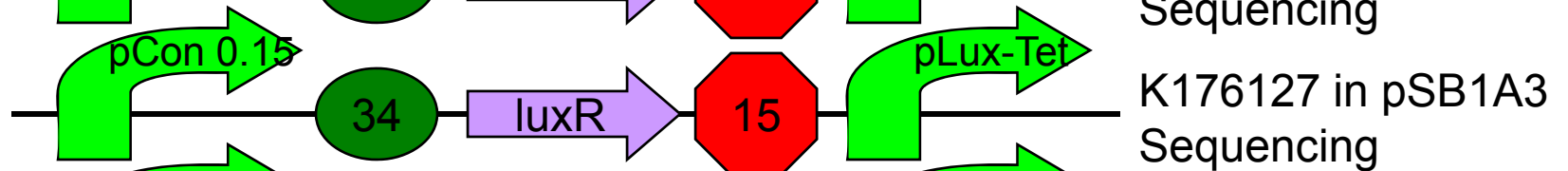
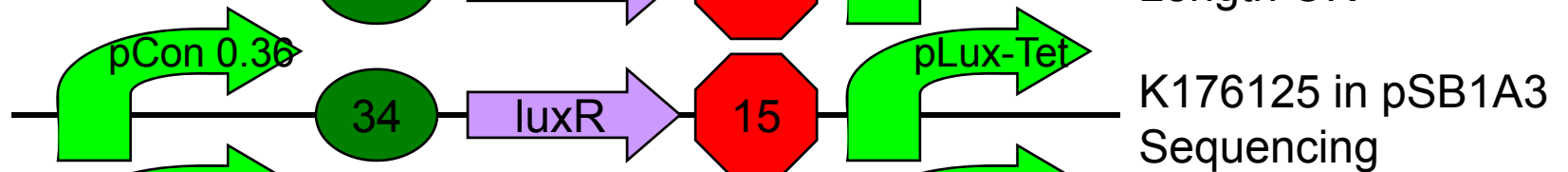
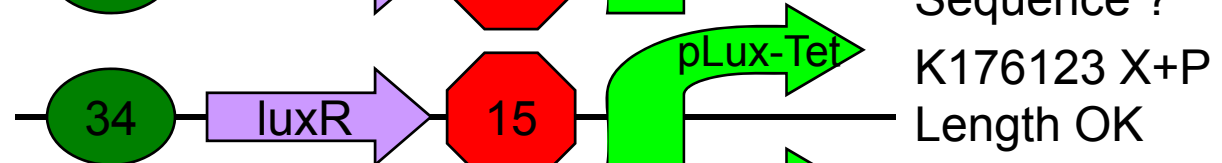
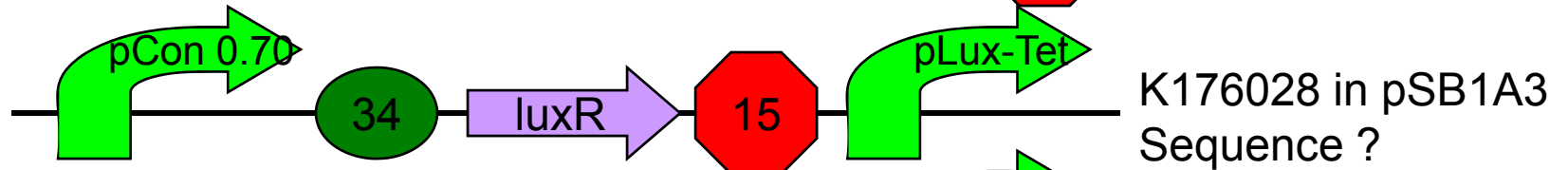
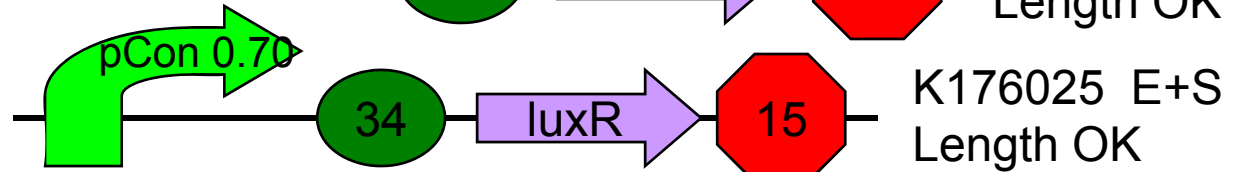
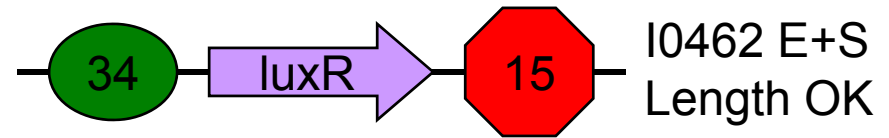
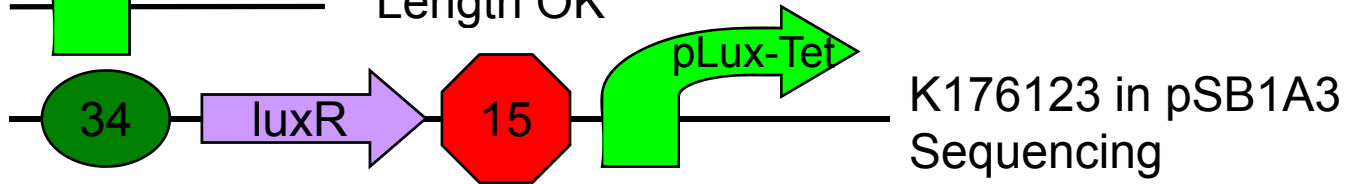
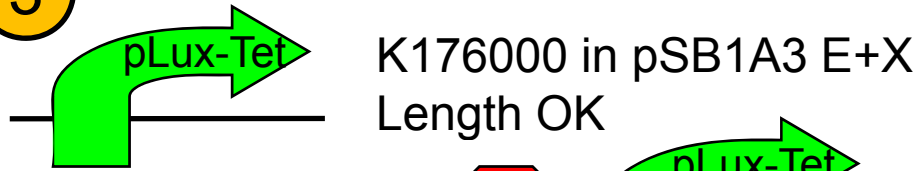

9

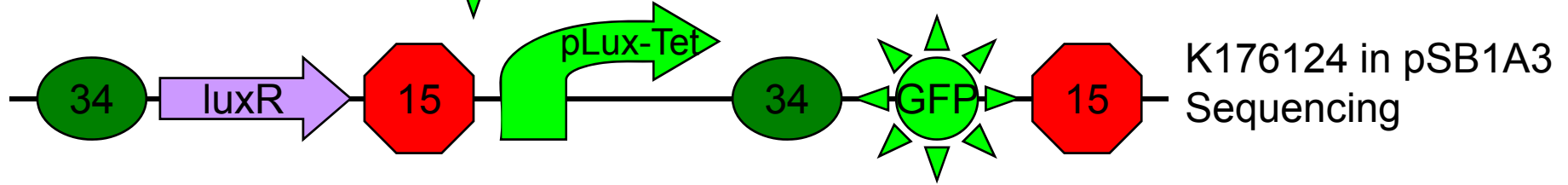
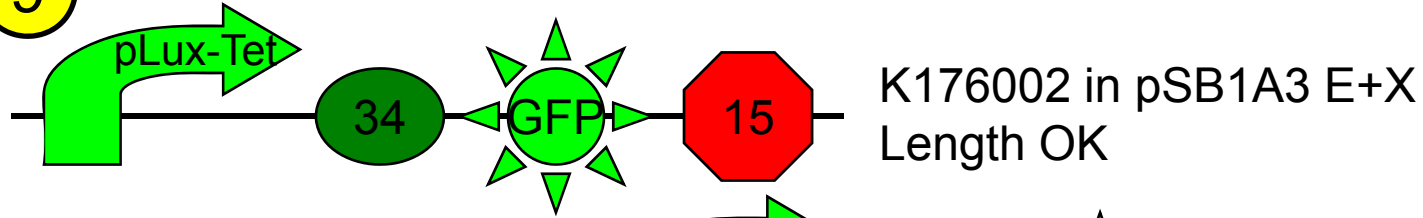

VRGFP ← G00201
Synthesis OK

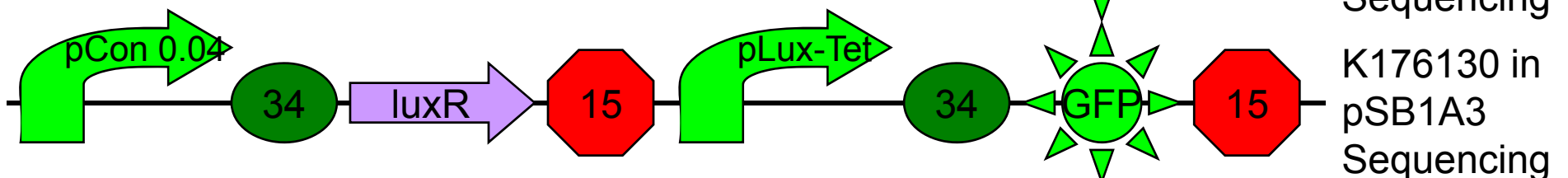
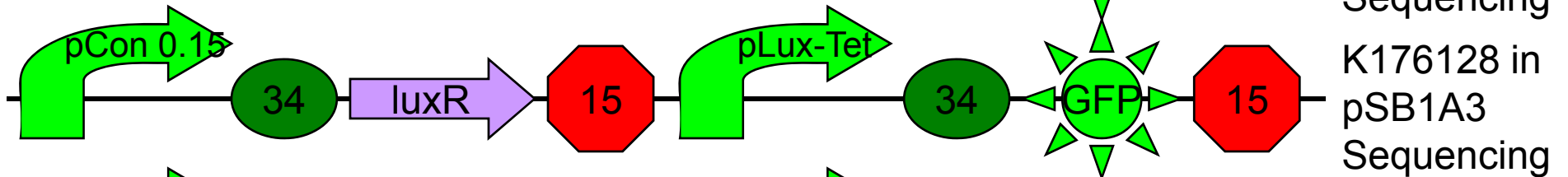
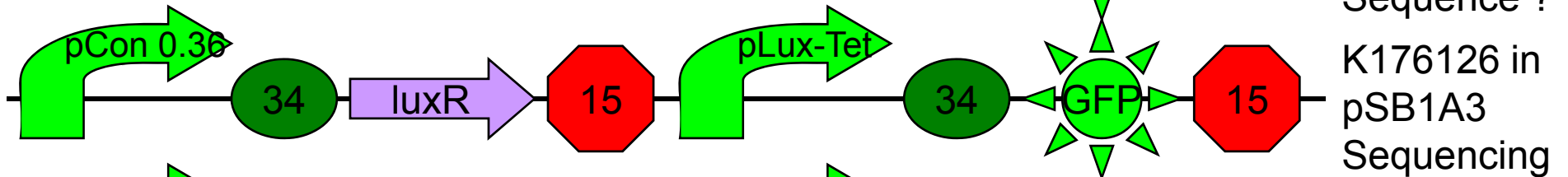
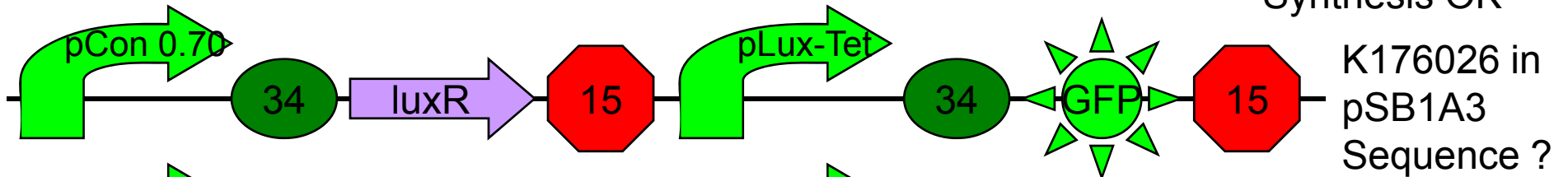

Methods

- Plate Reader
- Spectrophotometer

Flu:t(min)

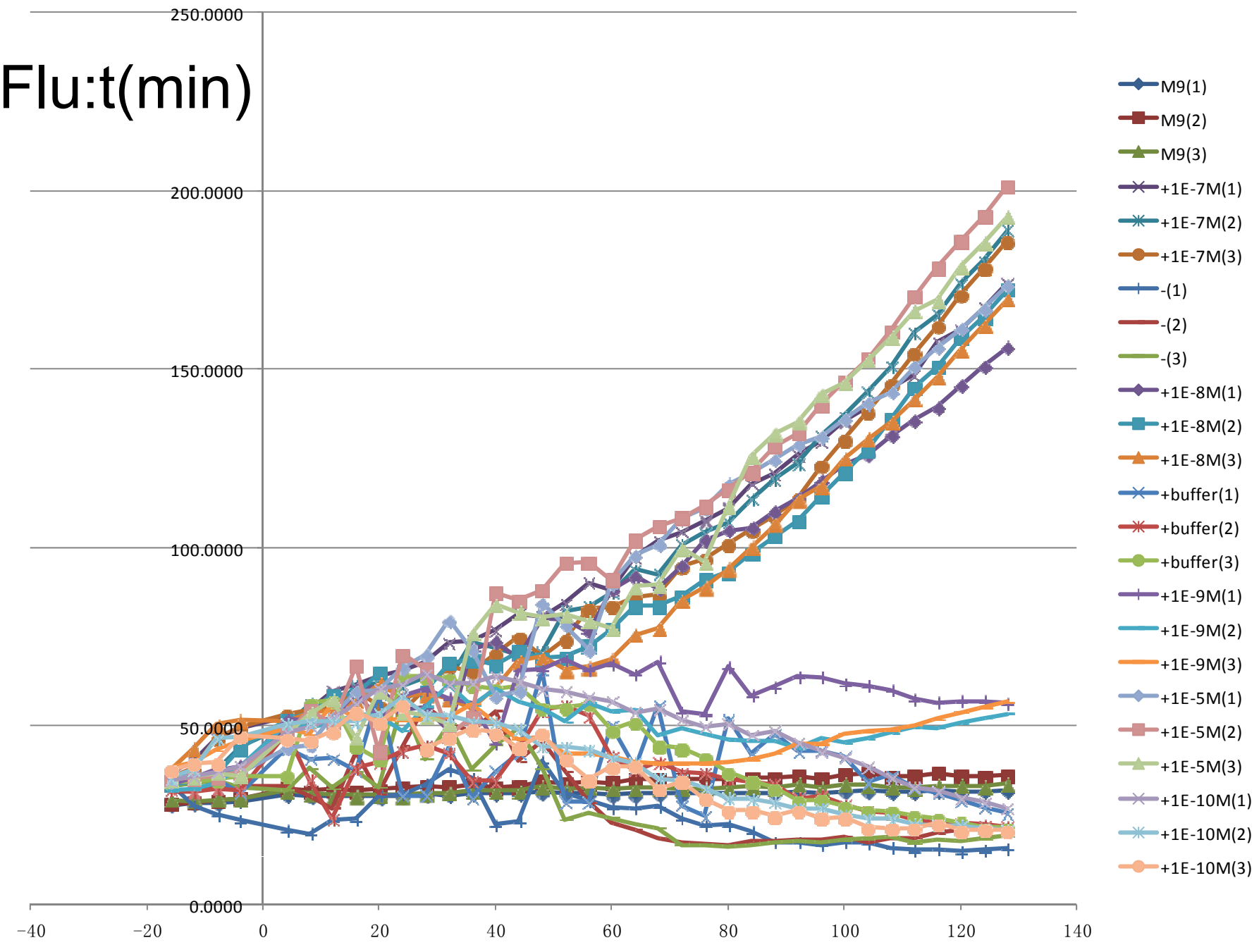

Flu/OD:t(min)

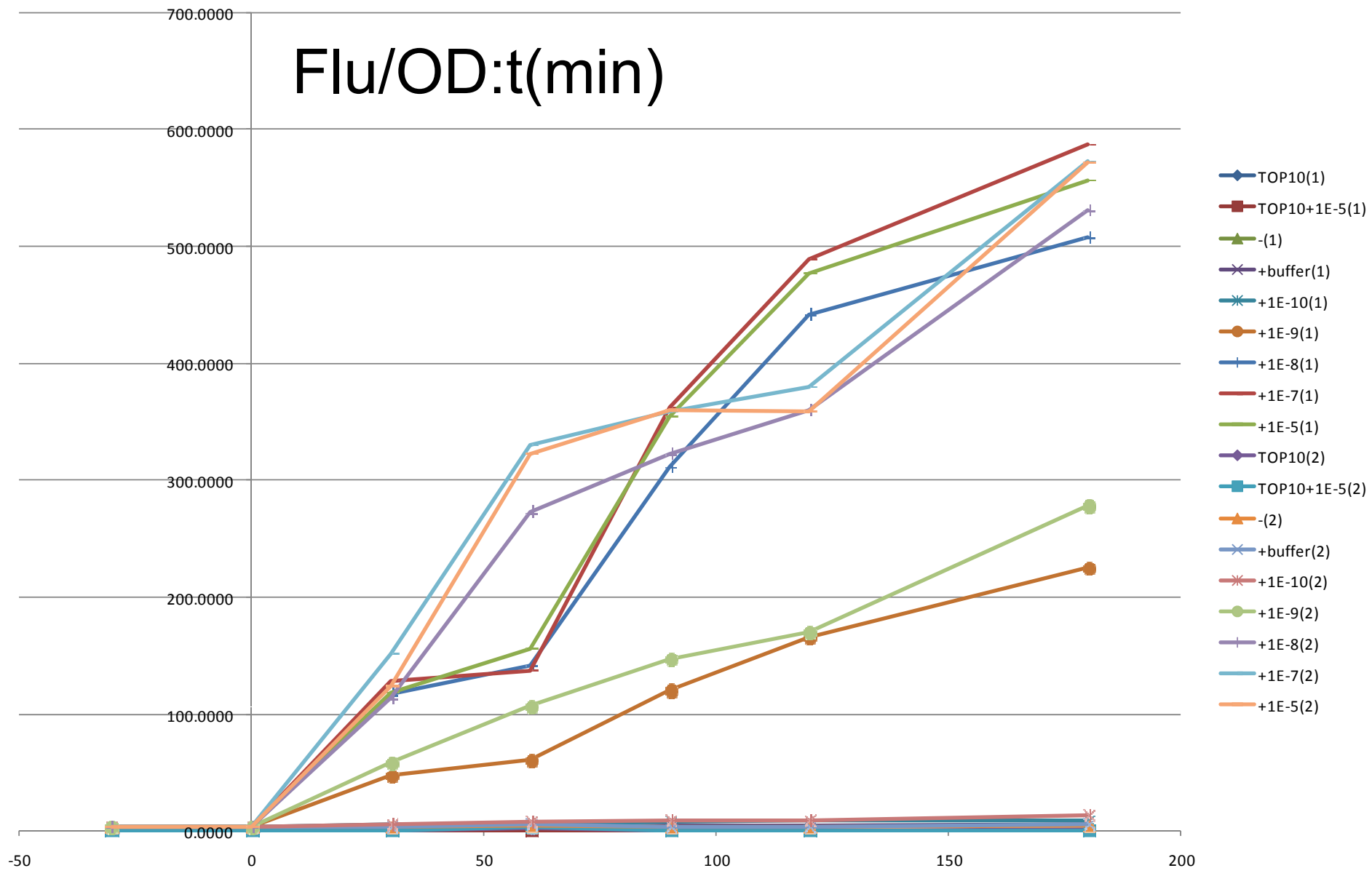

Flu/OD:t(min)

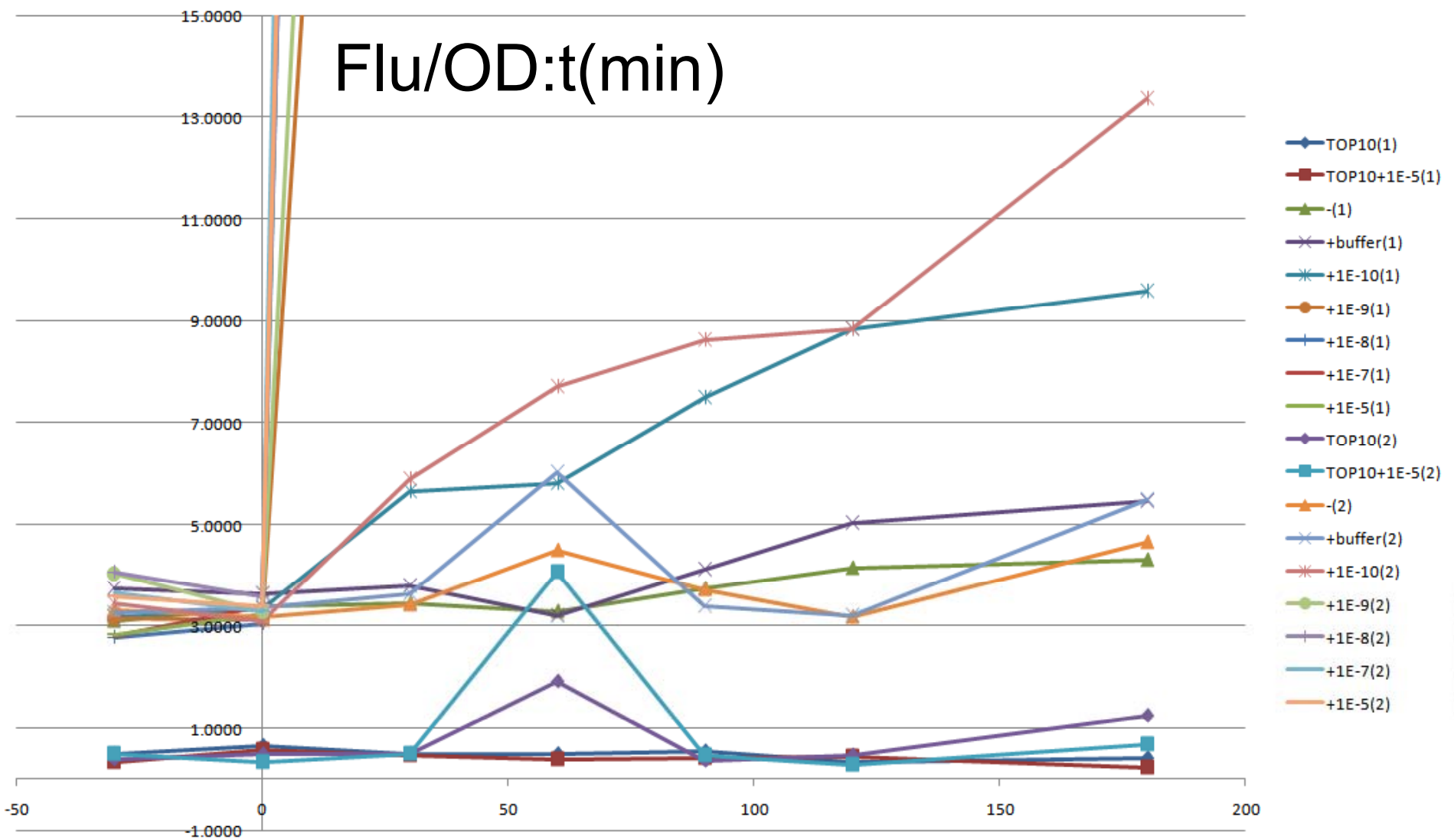

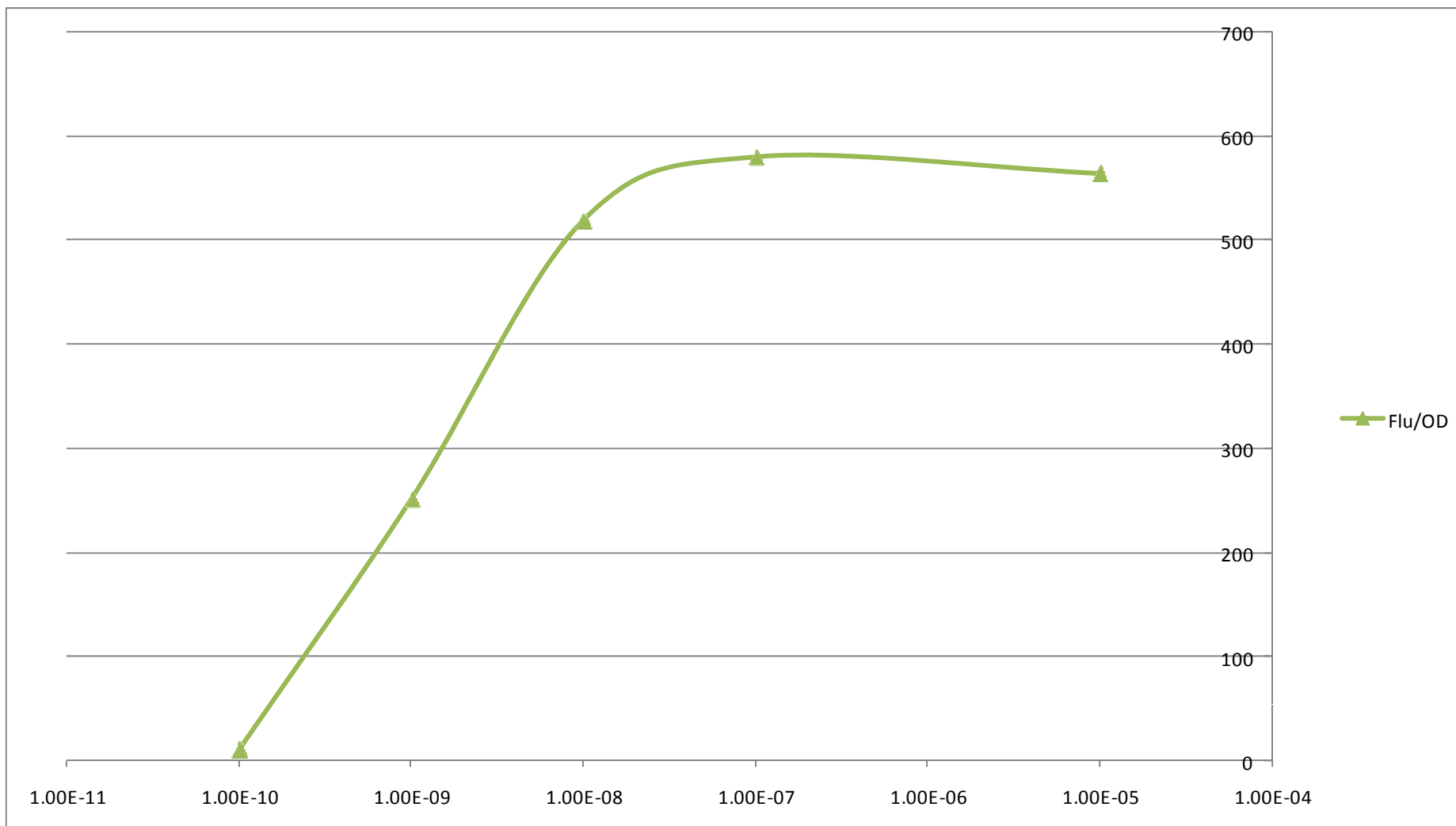

F2620

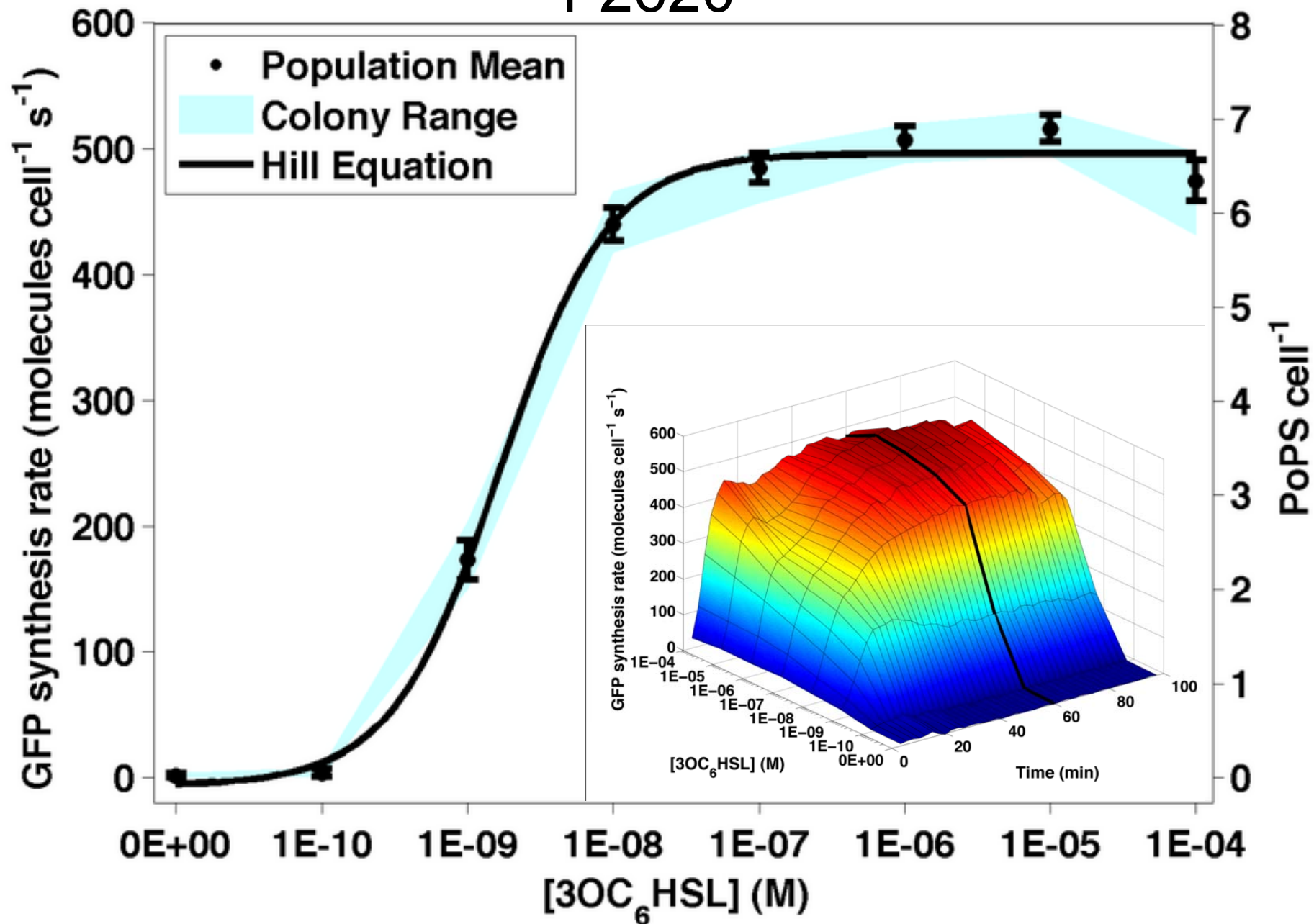

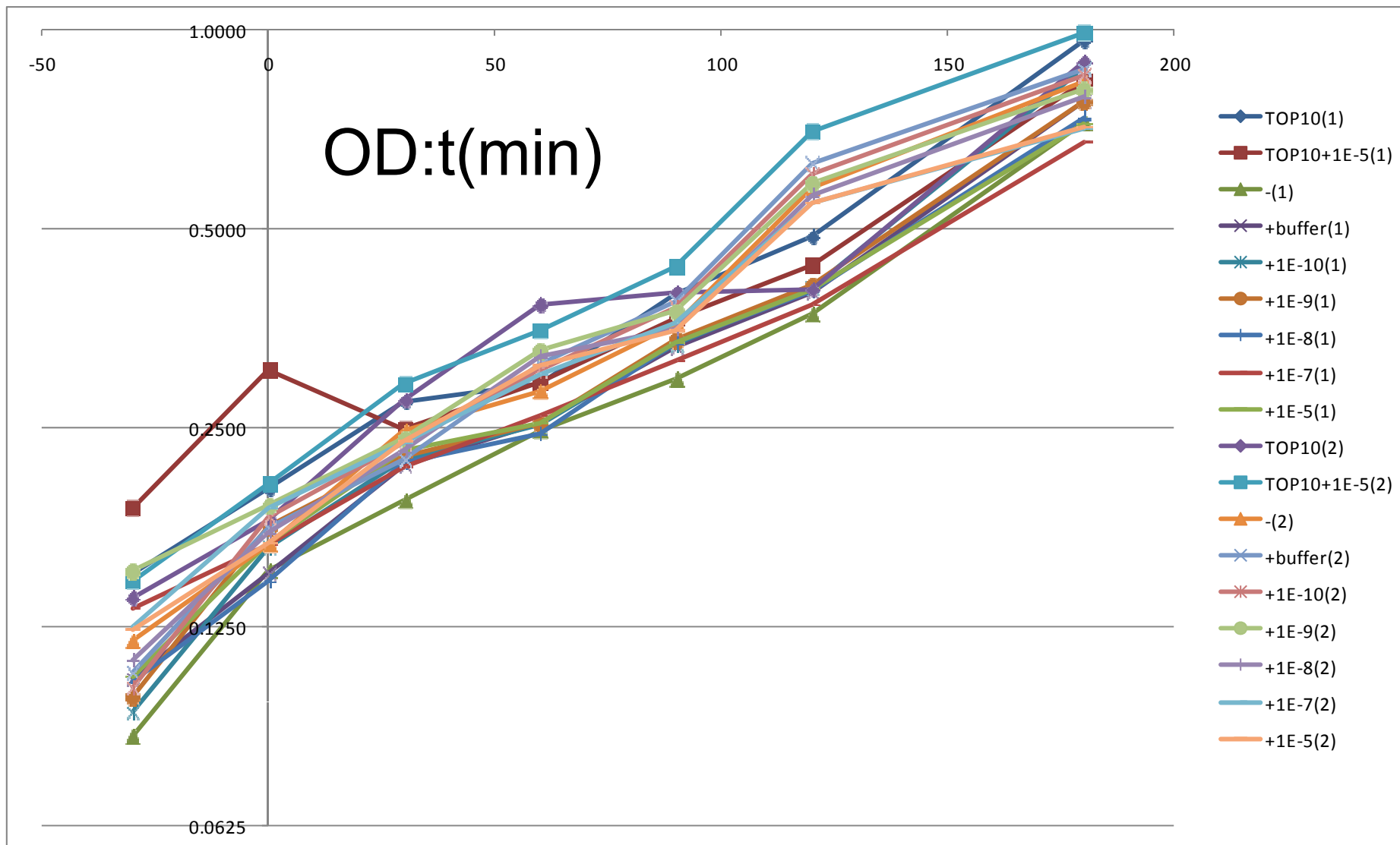

9+R+002 (K176126)

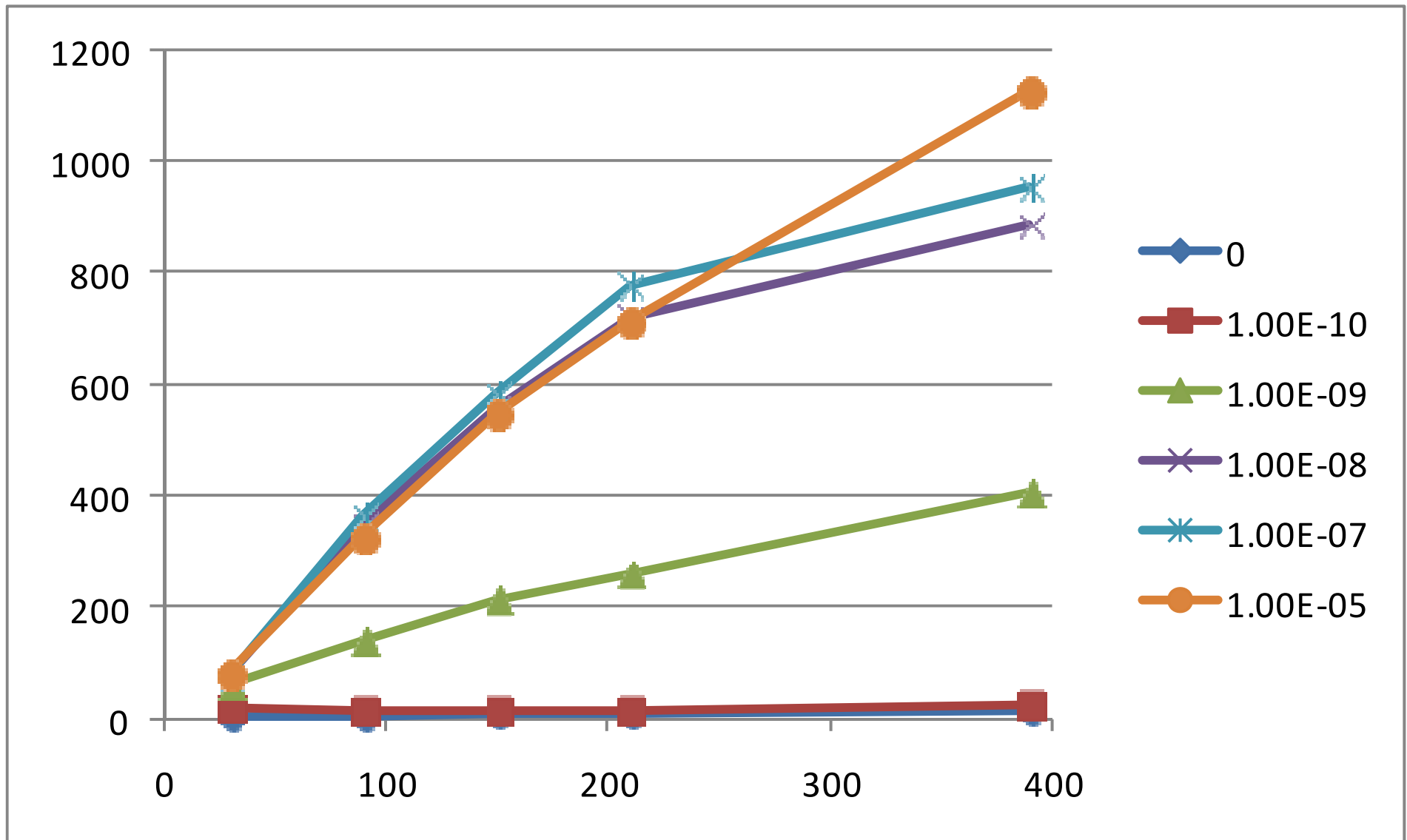

10+R+002 (K176130)

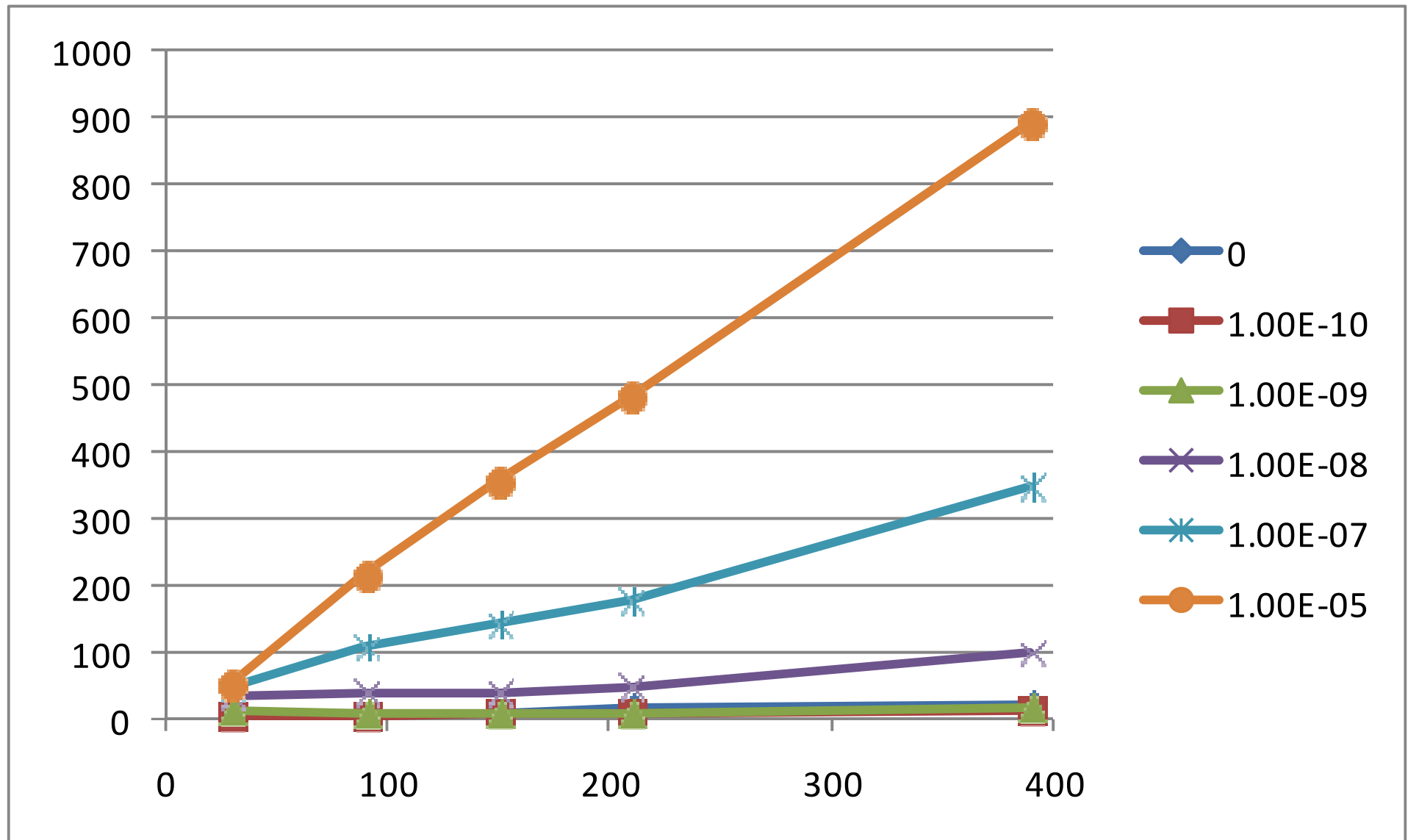

11+R+002 (K176128)

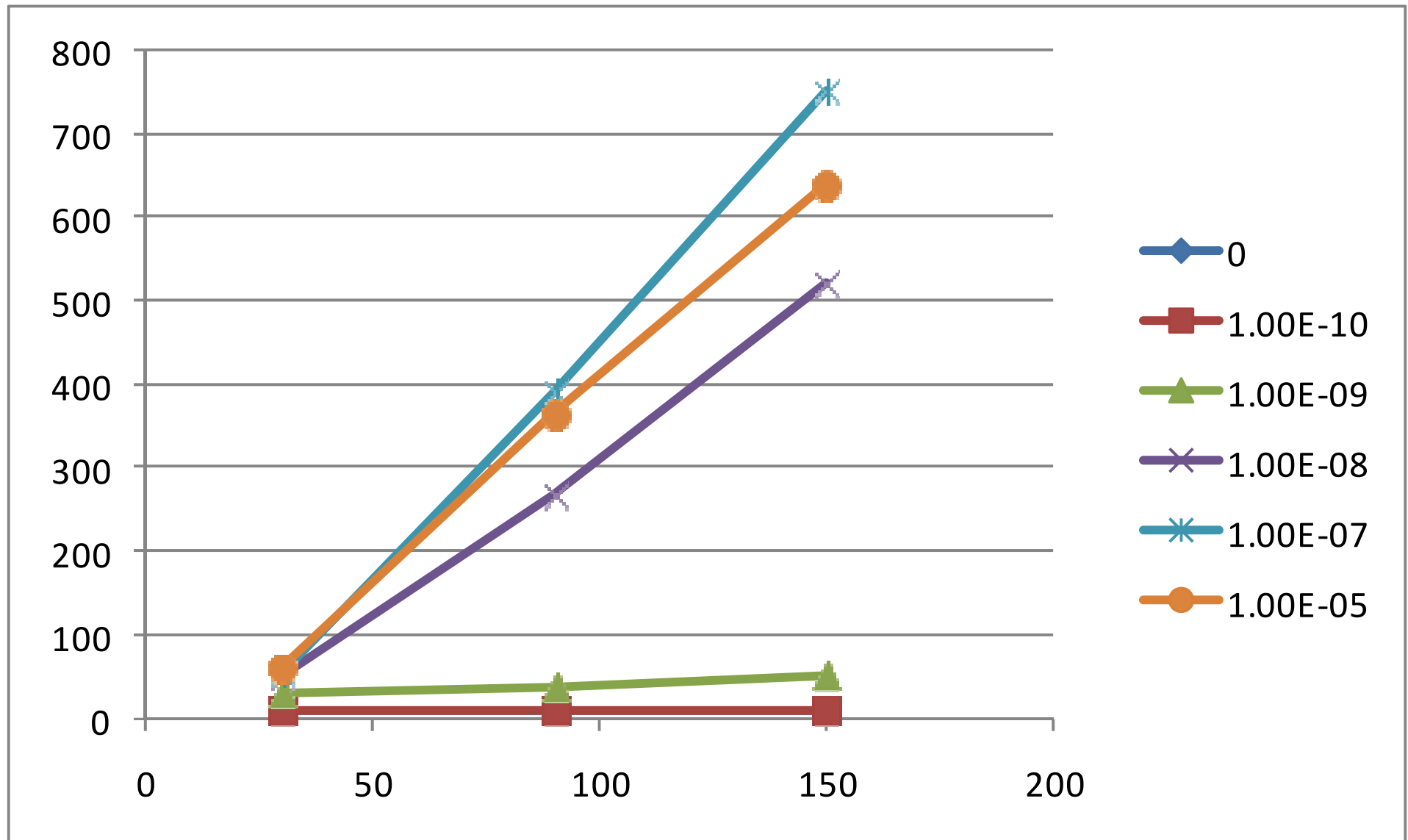

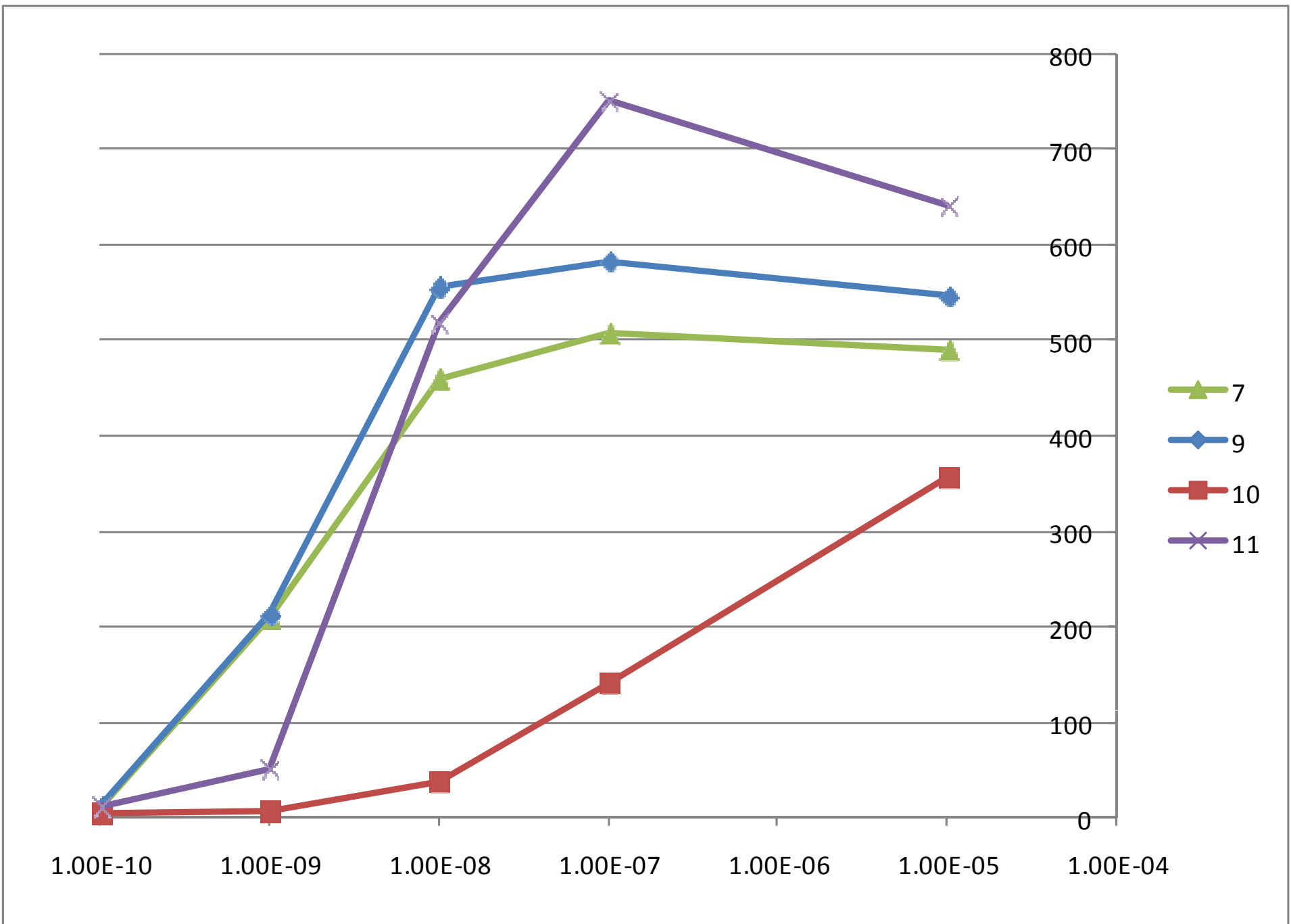

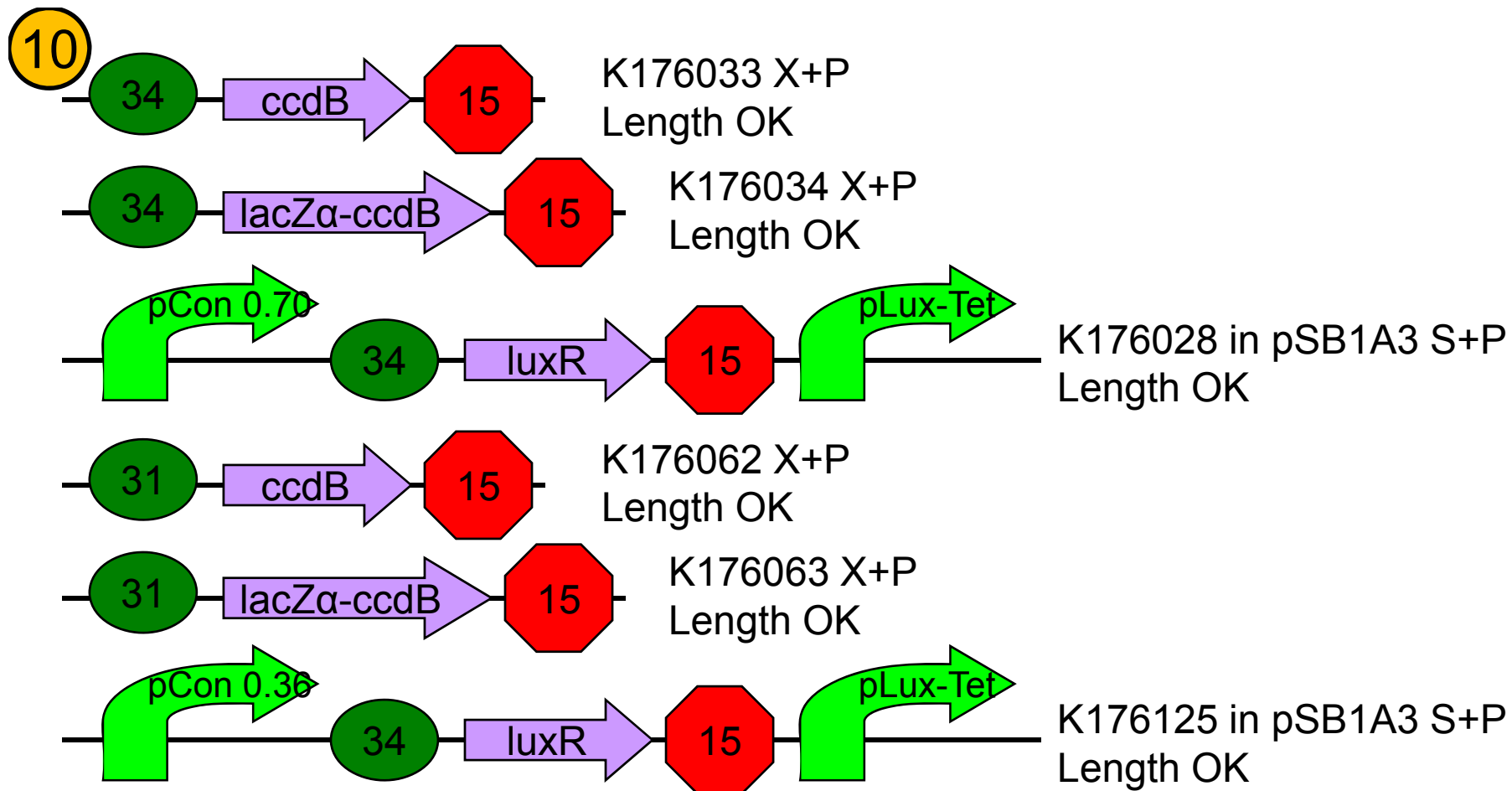

← VRccdB K176058
Synthesis OK

← M13-47 K176059
Synthesis OK

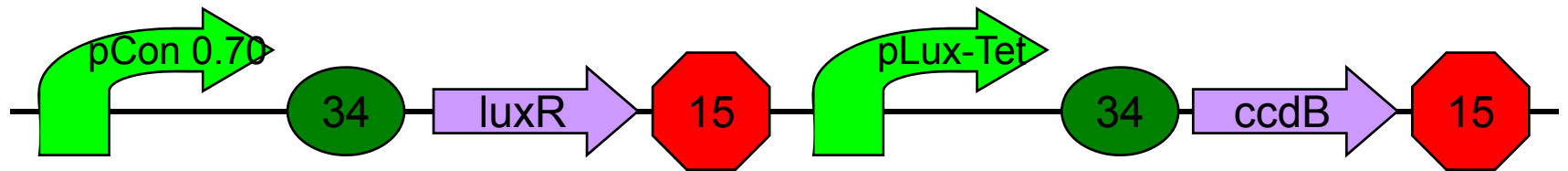

K176035 in pSB1A3 in DB3.1
Sequence ?

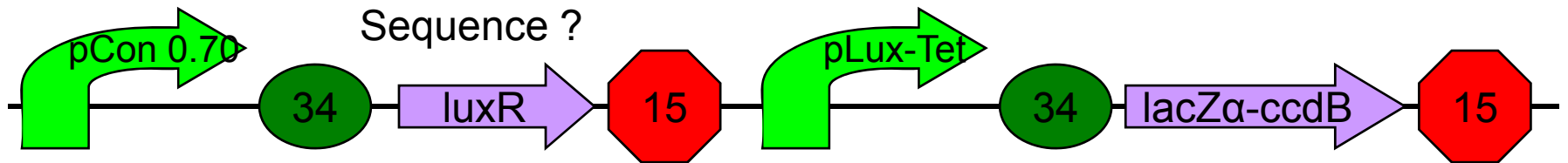

K176036 in pSB1A3 in DB3.1
Sequence OK

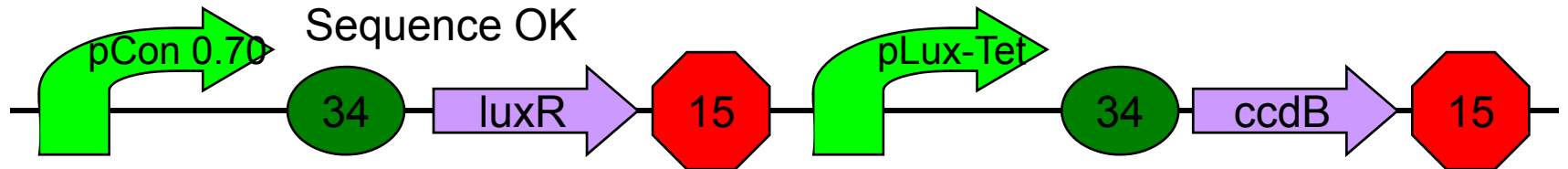

K176035 in pSB1A3 in TOP10
Transformation Fail

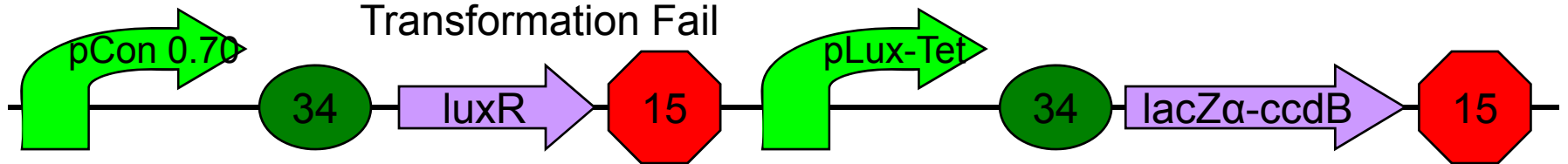

K176036 in pSB1A3 in TOP10
Transformation Fail

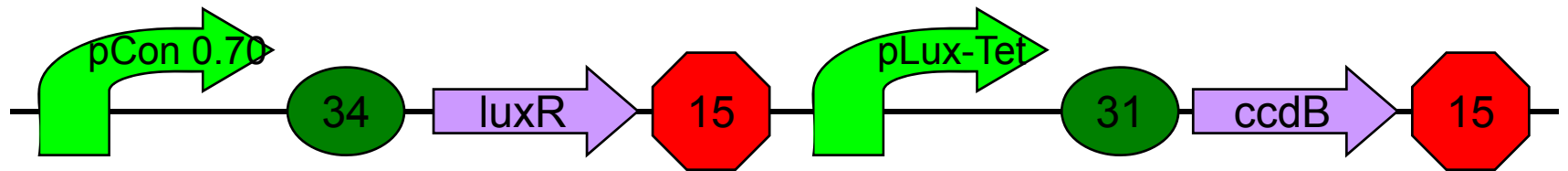

K176089 in pSB1A3 in DB3.1

Sequencing

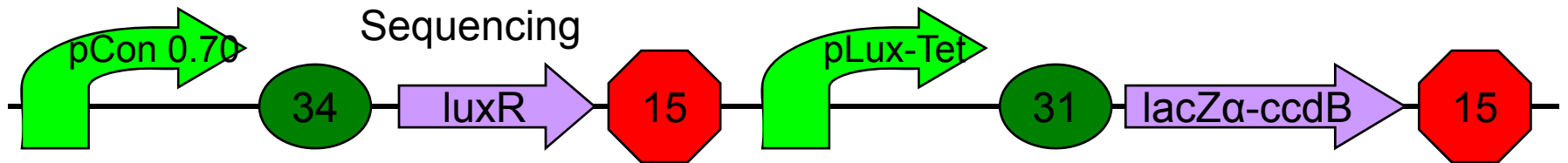

K176090 in pSB1A3 in DB3.1

Sequence ?

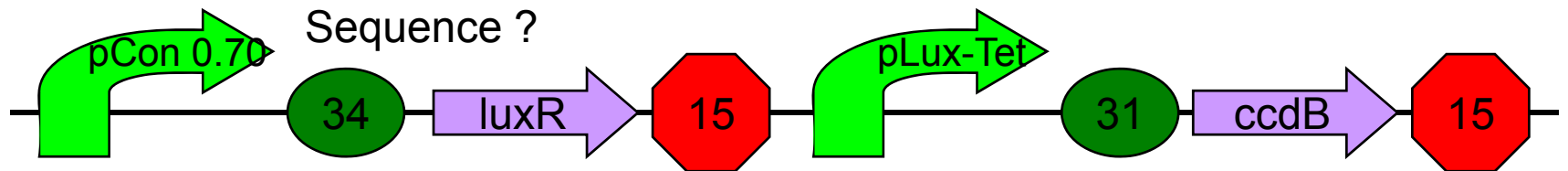

K176089 in pSB1A3 in TOP10

Transformation

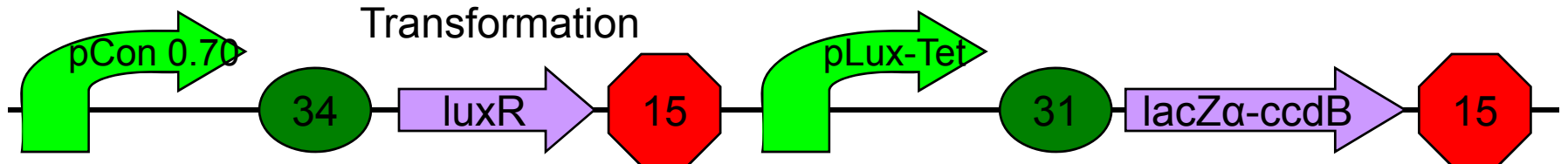

K176090 in pSB1A3 in TOP10

Transformation

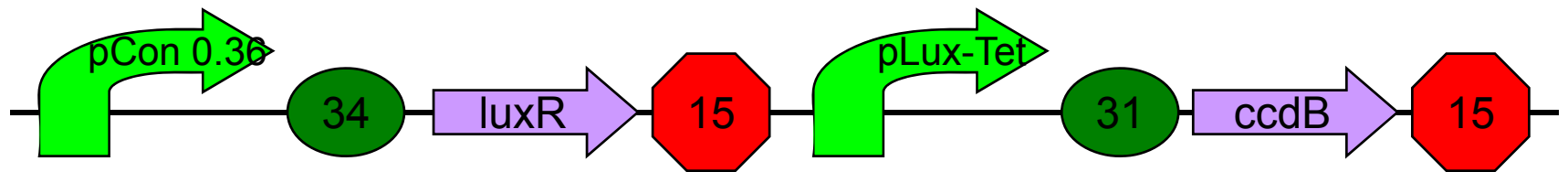

K176131 in pSB1A3 in DB3.1

Ligation

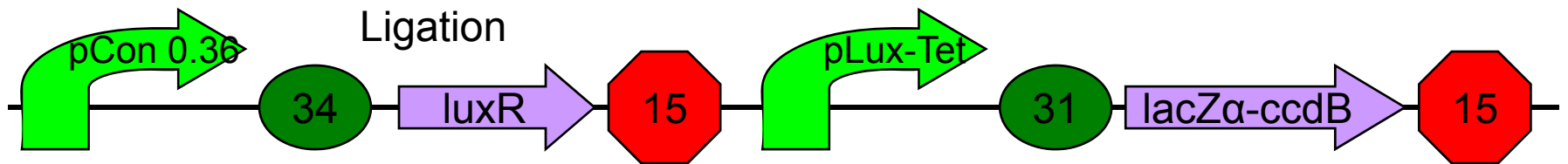

K176132 in pSB1A3 in DB3.1

Ligation

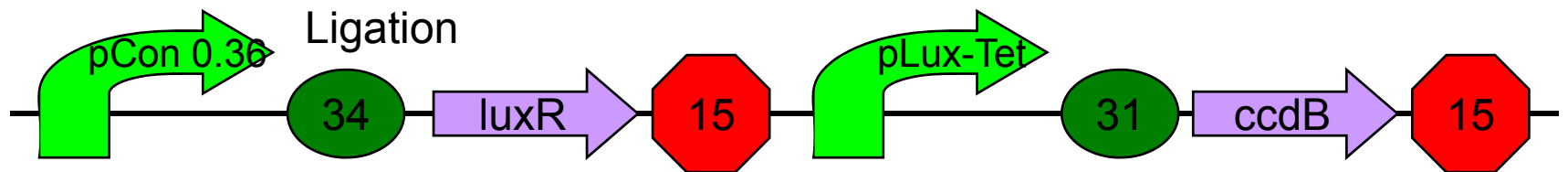

K176131 in pSB1A3 in TOP10

Waiting

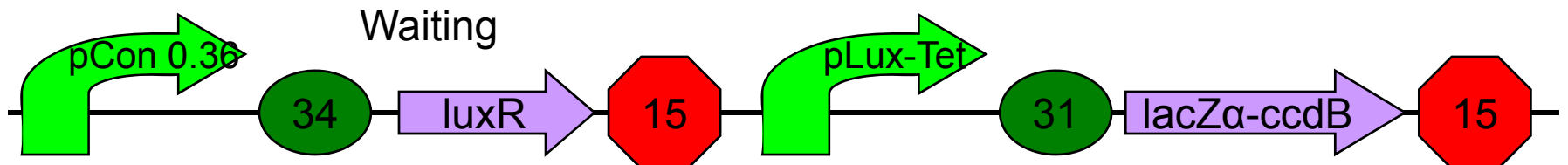

K176132 in pSB1A3 in TOP10

Waiting

11

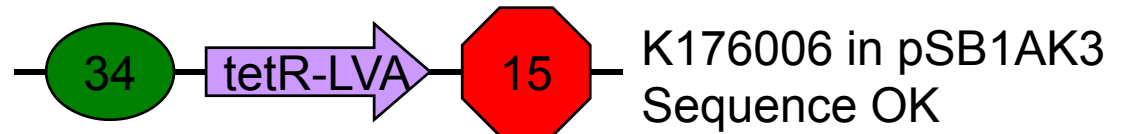
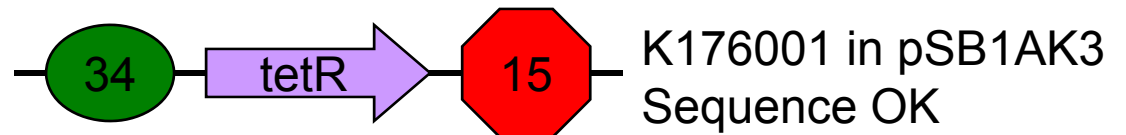
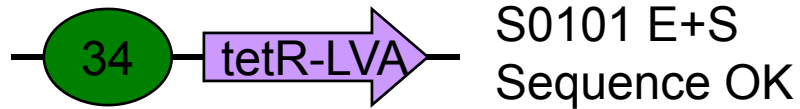
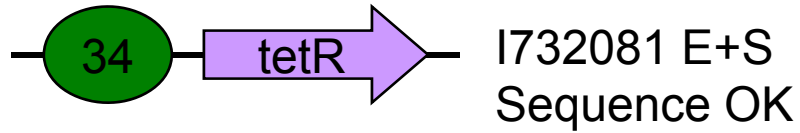
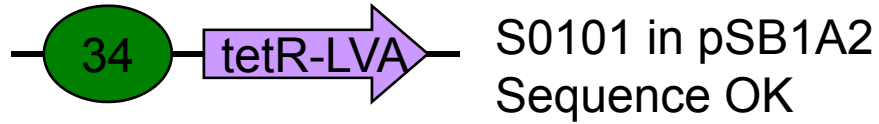
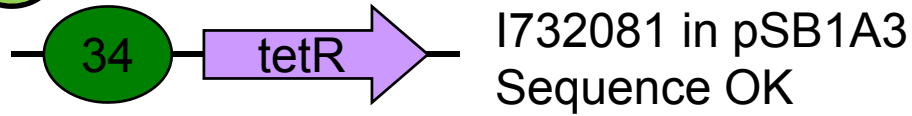

12

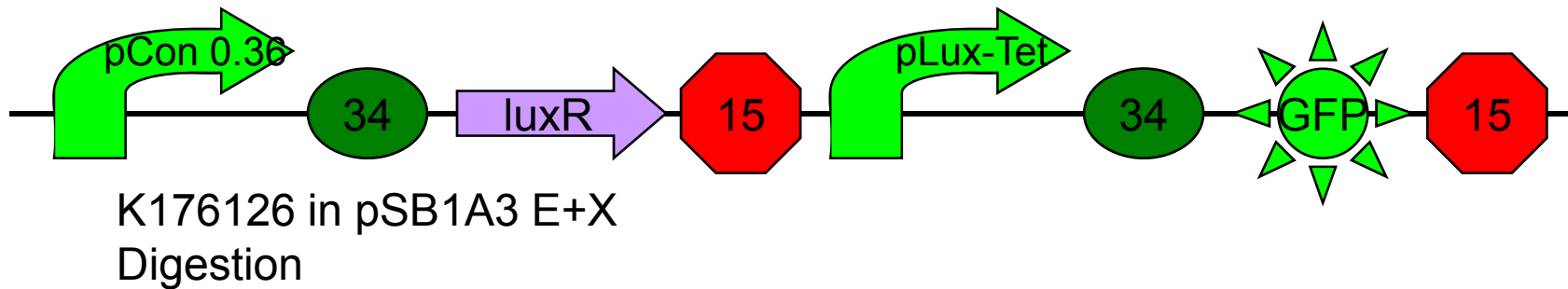
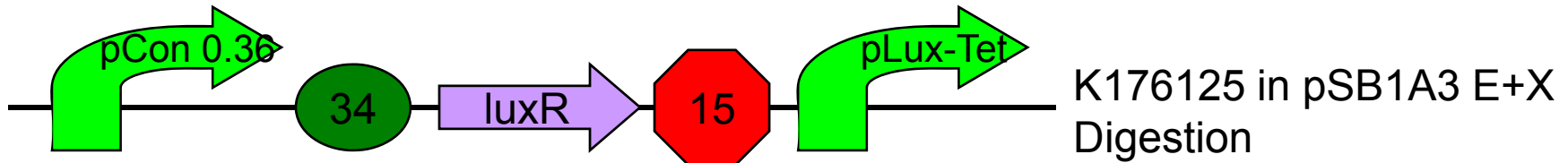
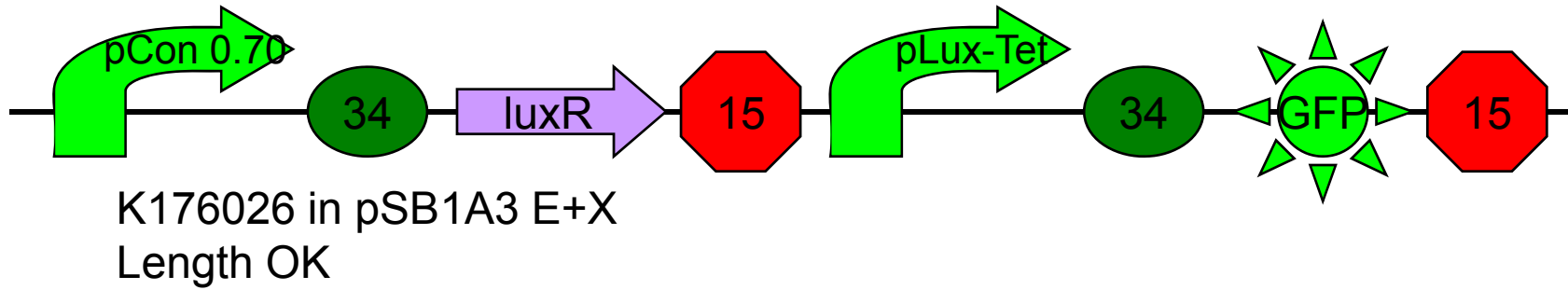
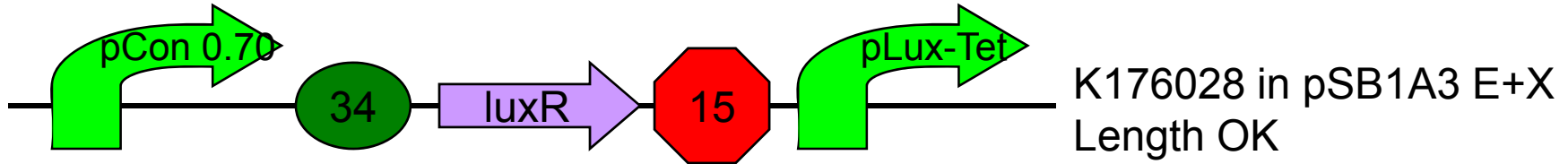
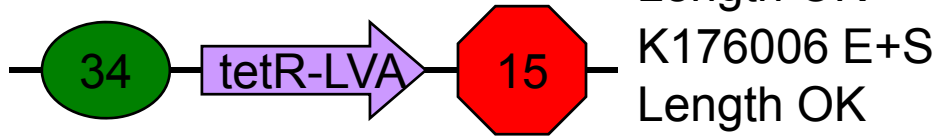
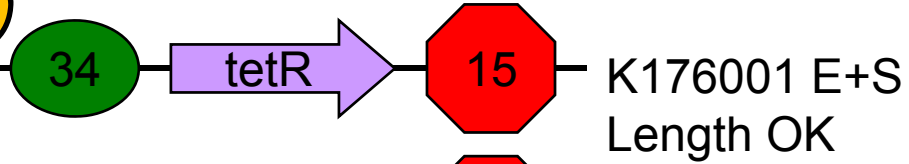



K176057
Synthesis OK

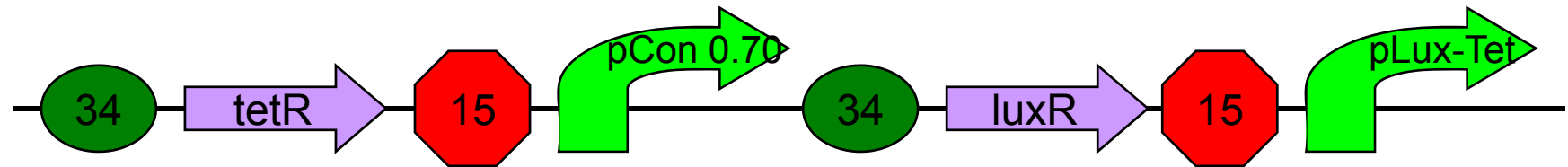

K176031 in pSB1A3
Sequence OK

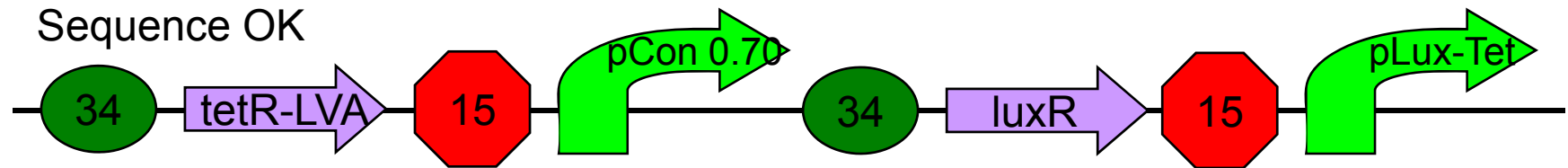

K176032 in pSB1A3
Sequence OK

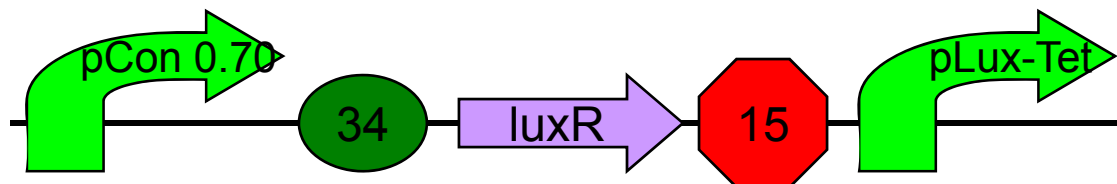
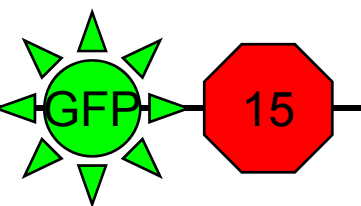
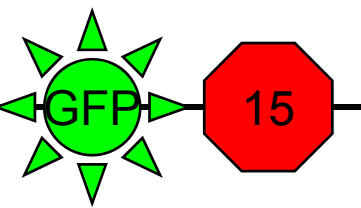
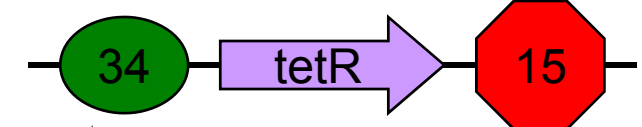

K176029 in pSB1A3
Sequence ?

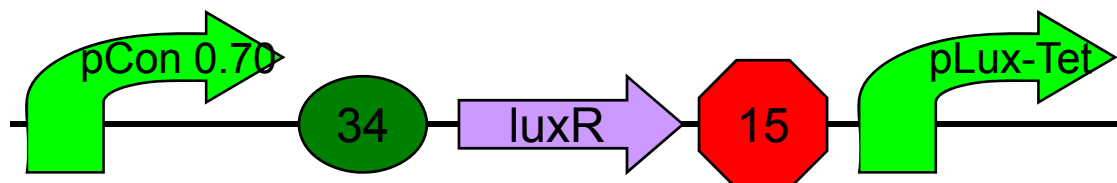

K176030 in pSB1A3
Sequence ?

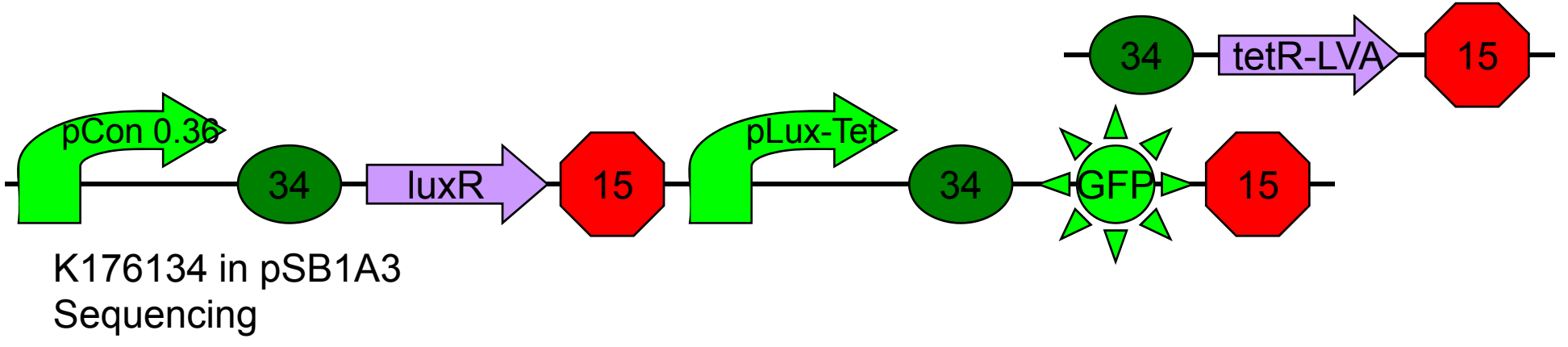
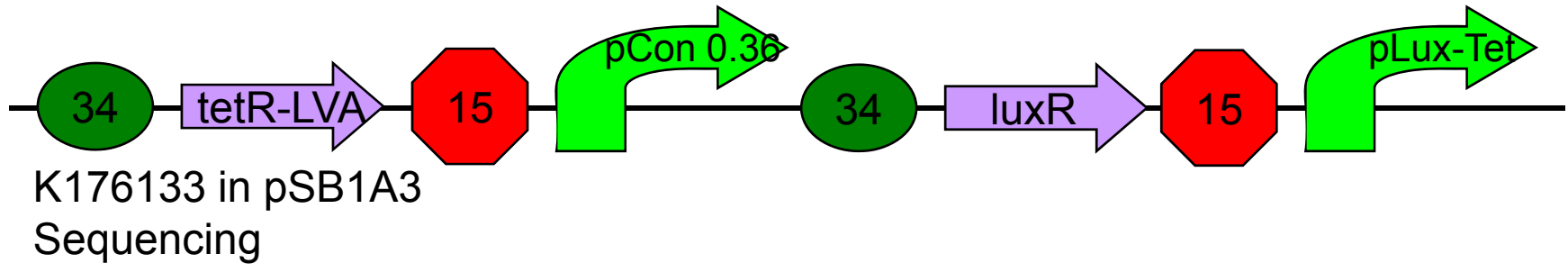

13

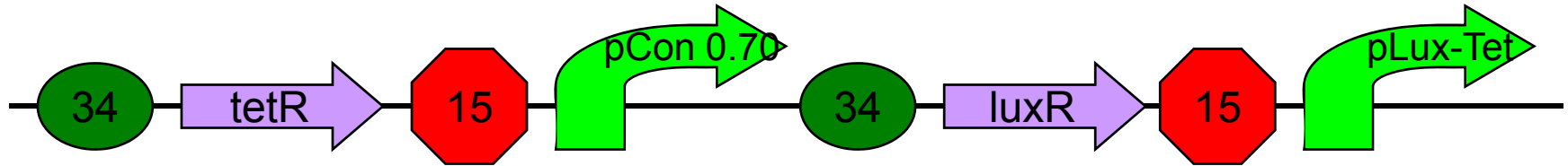

K176031 X+P
Length OK

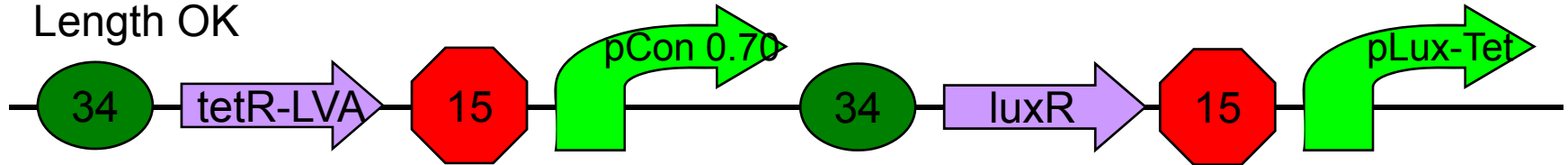

K176032 X+P
Length OK

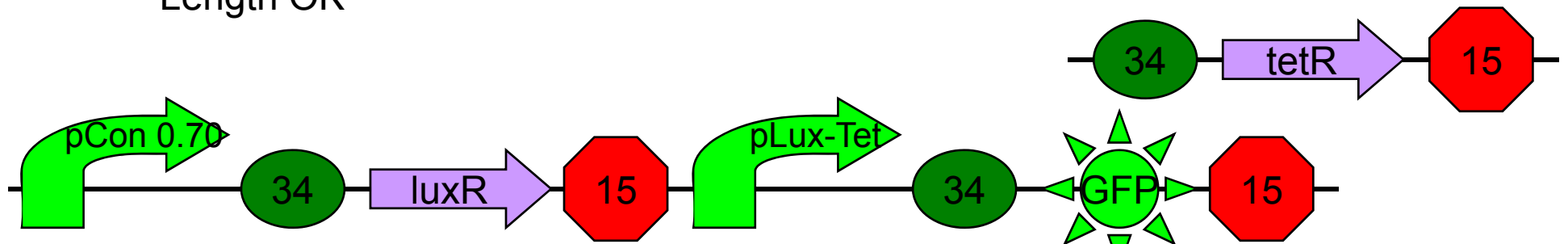

K176029 X+P
Length OK

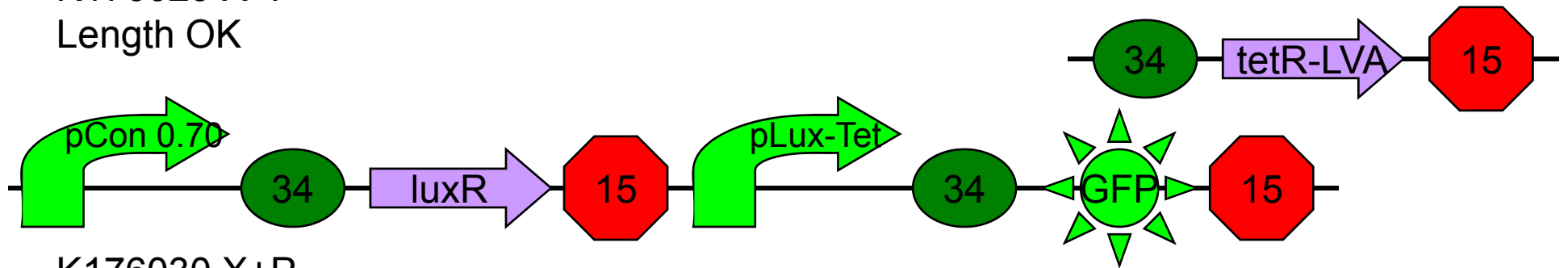

K176030 X+P
Length OK

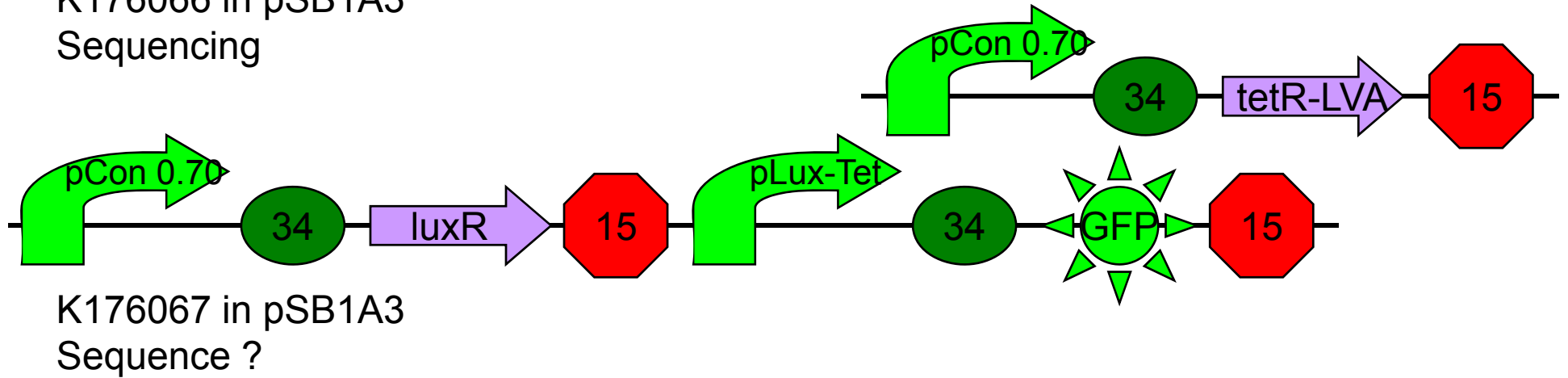
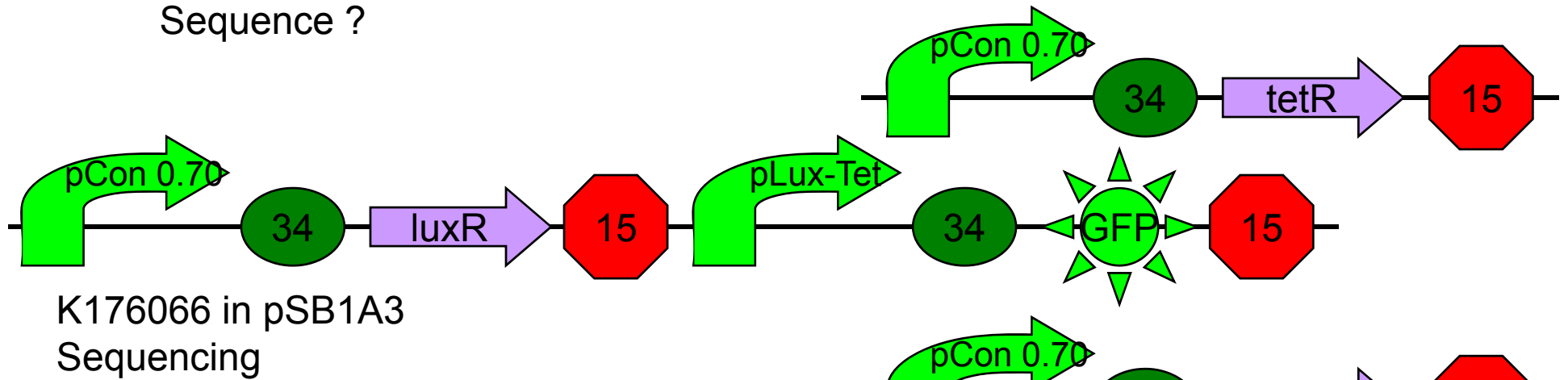
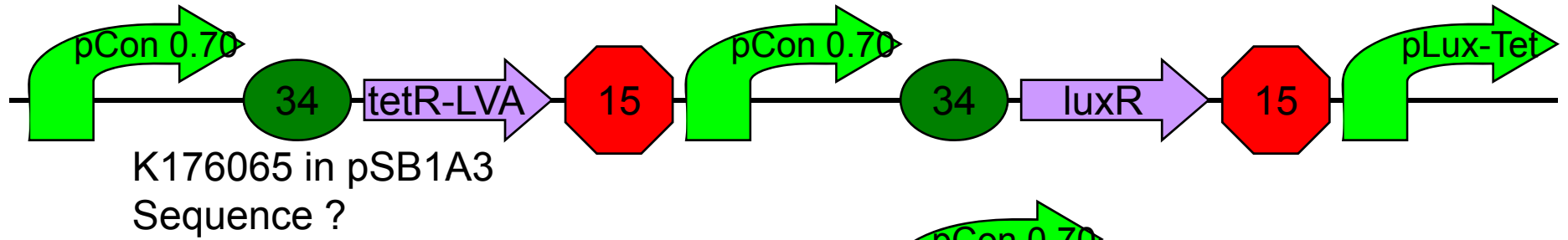
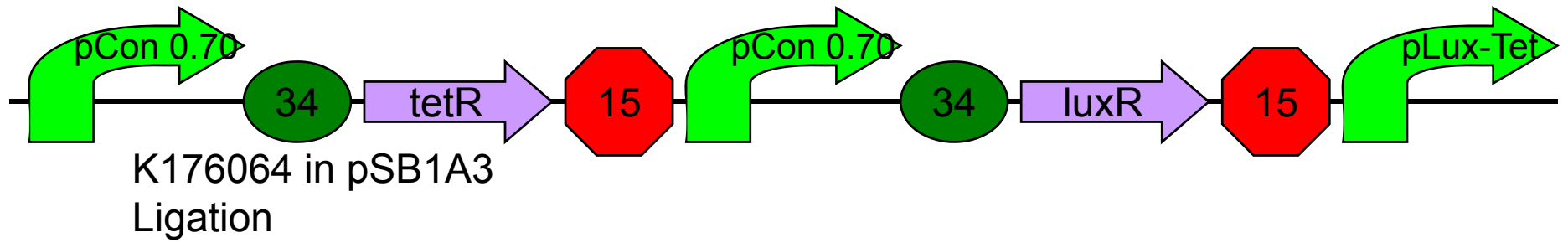

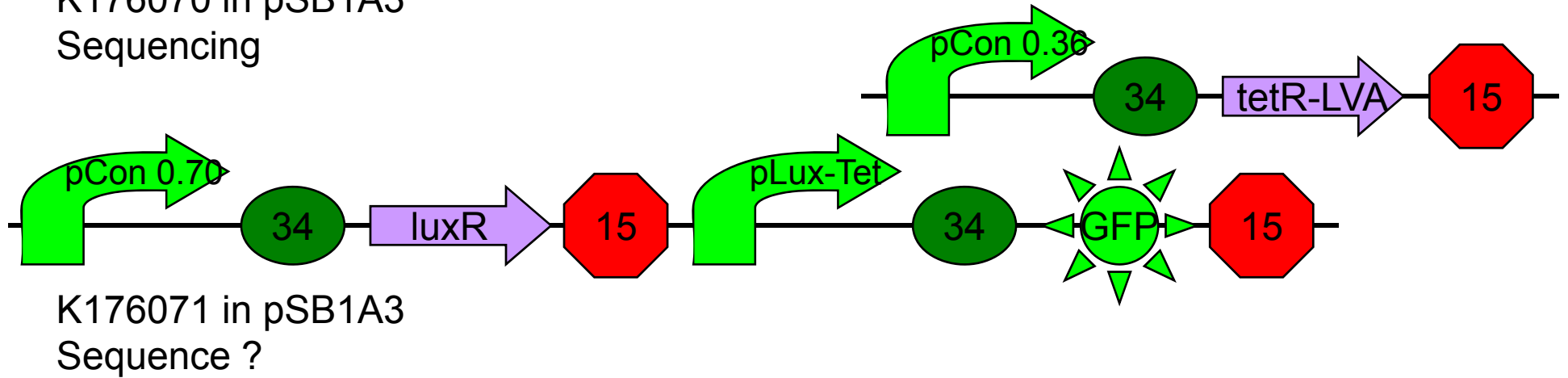
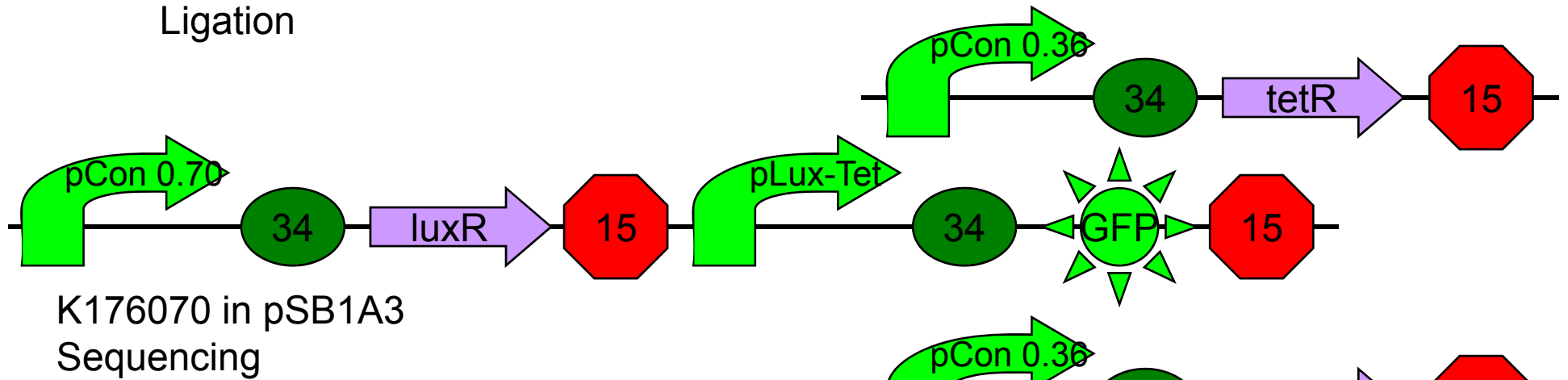
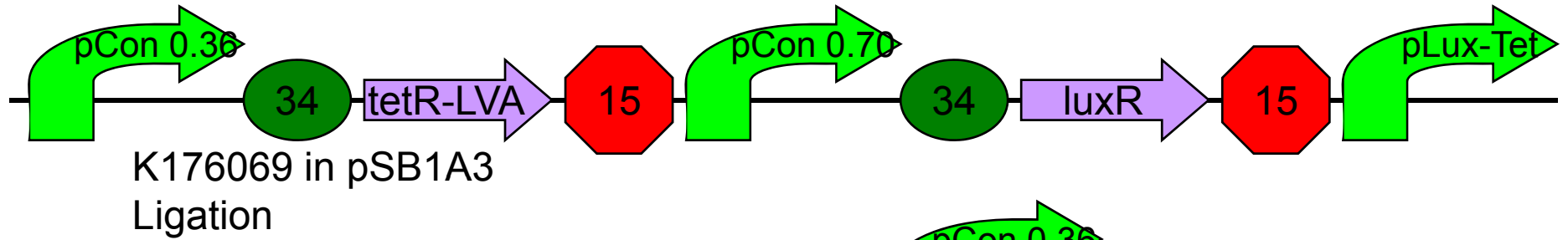
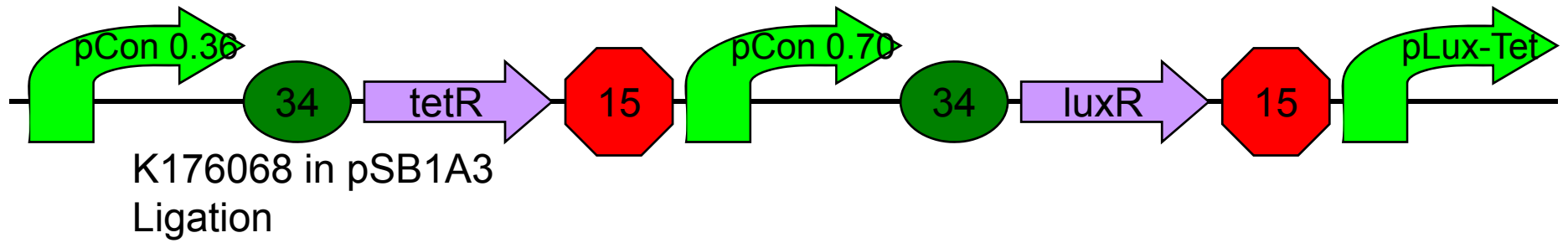

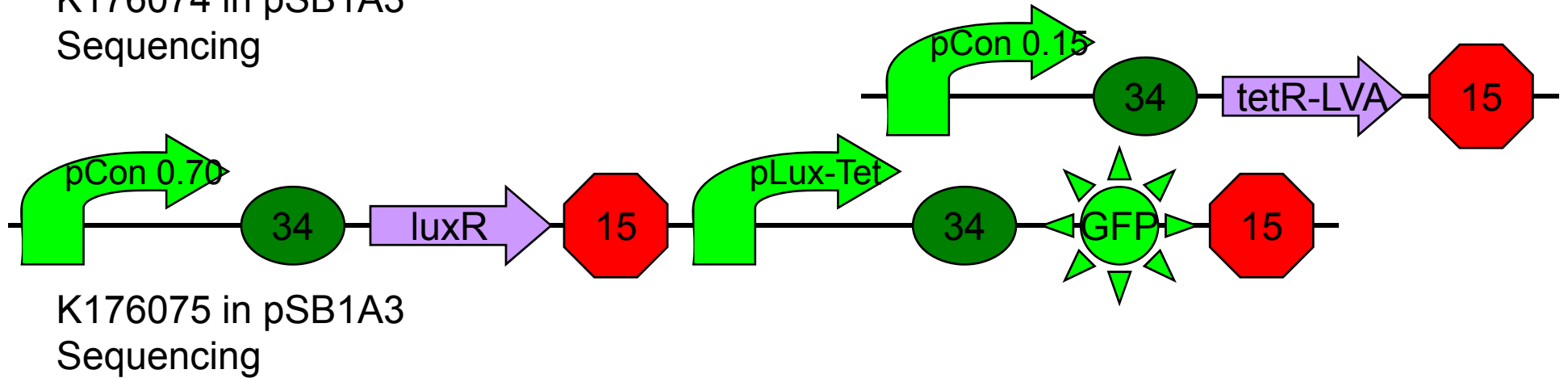
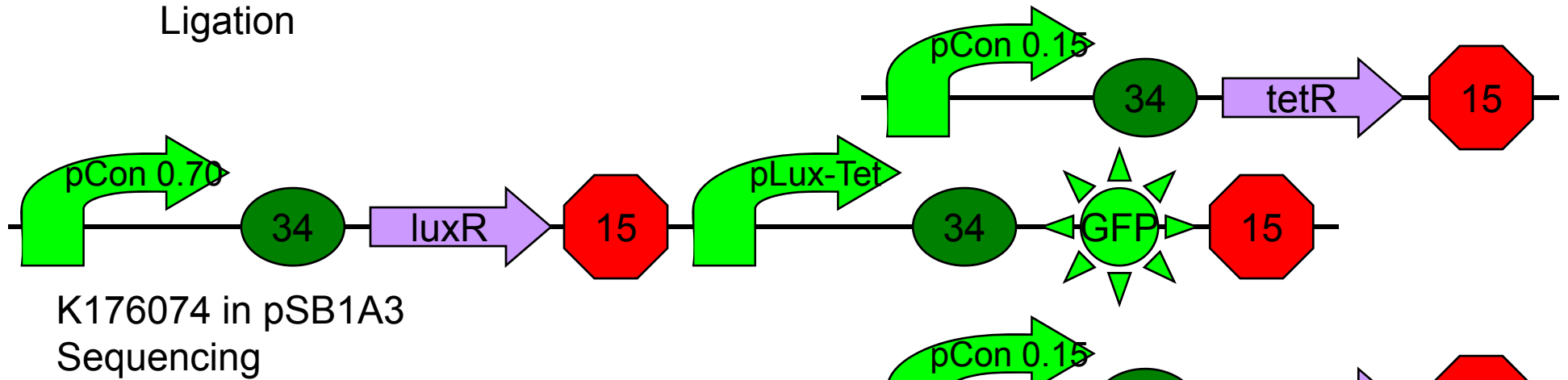
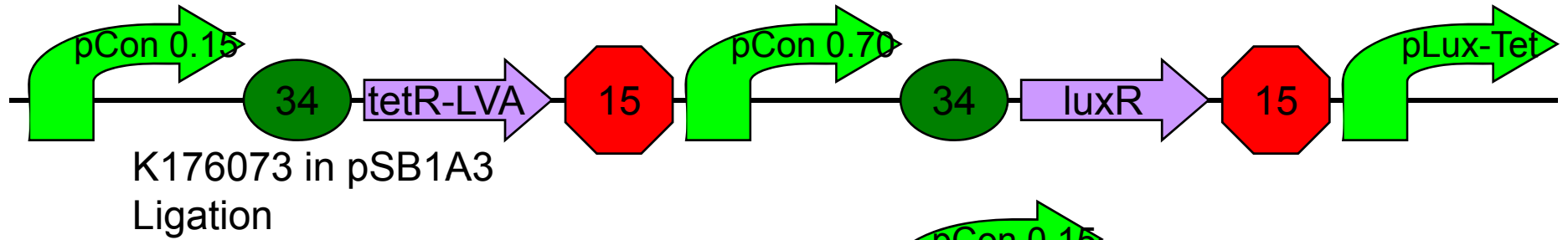
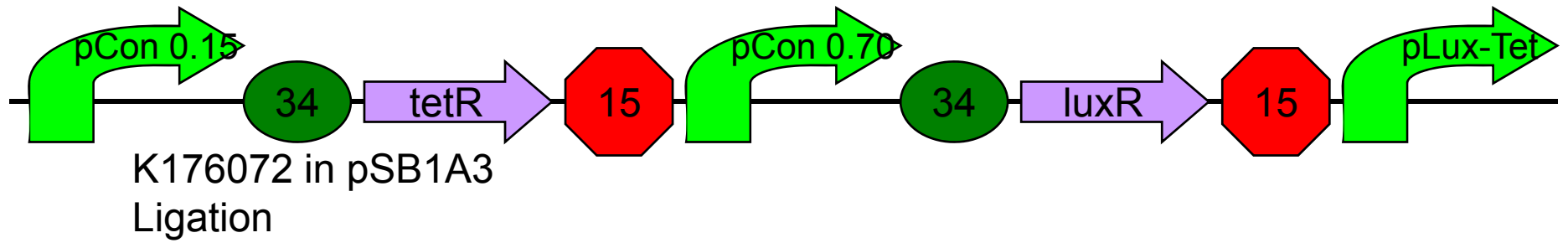

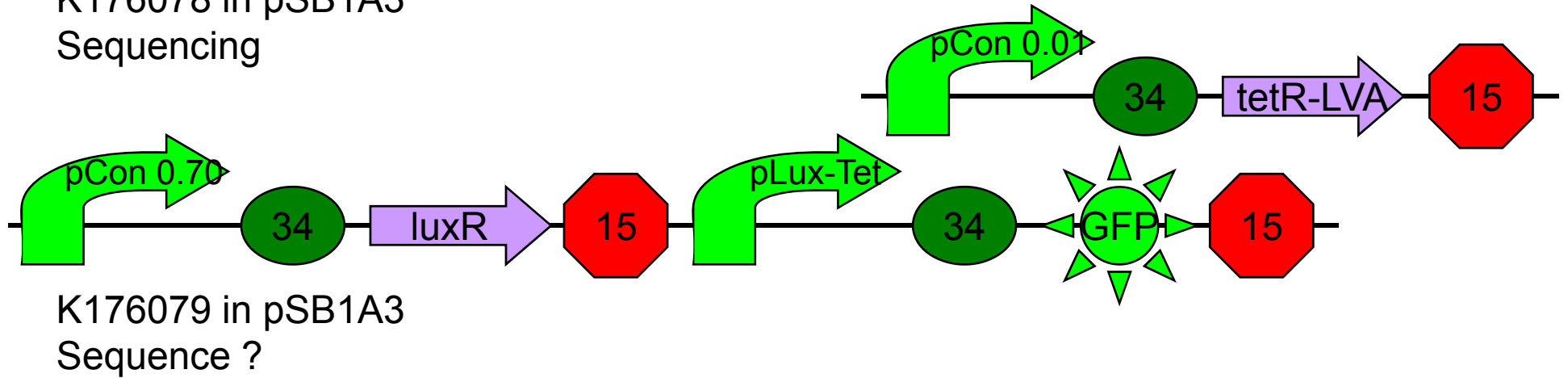
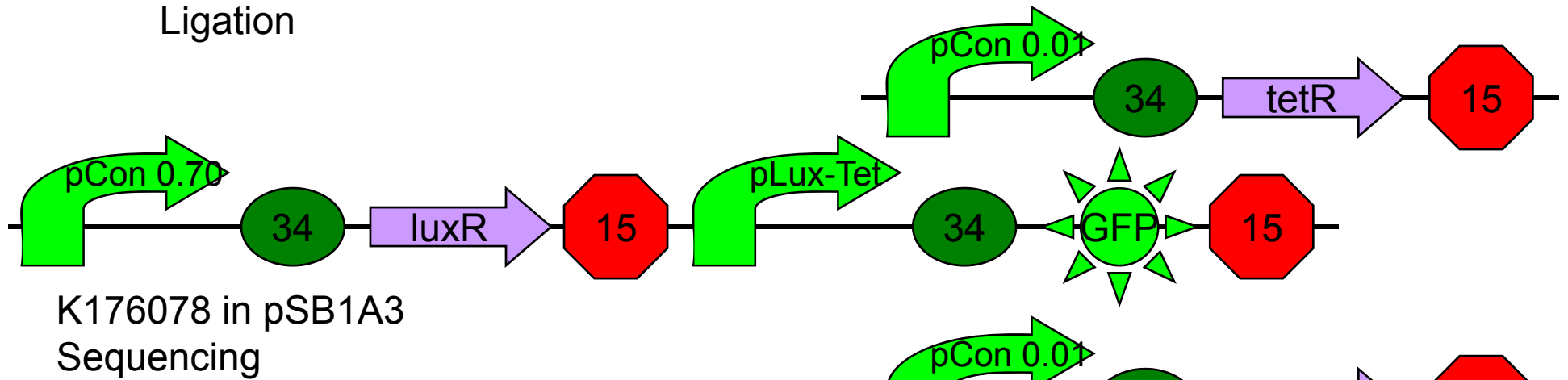
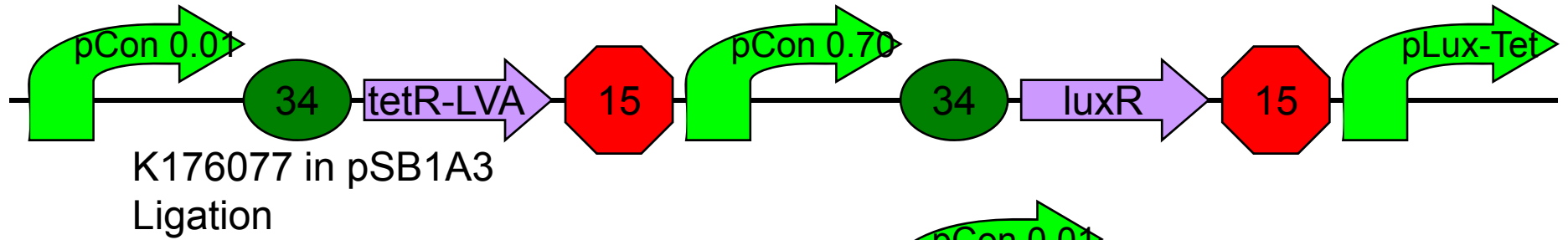
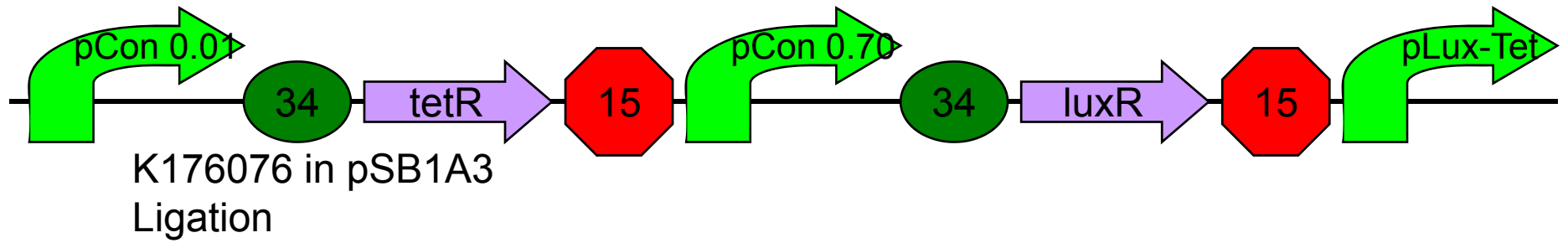

K176067 (7+30)

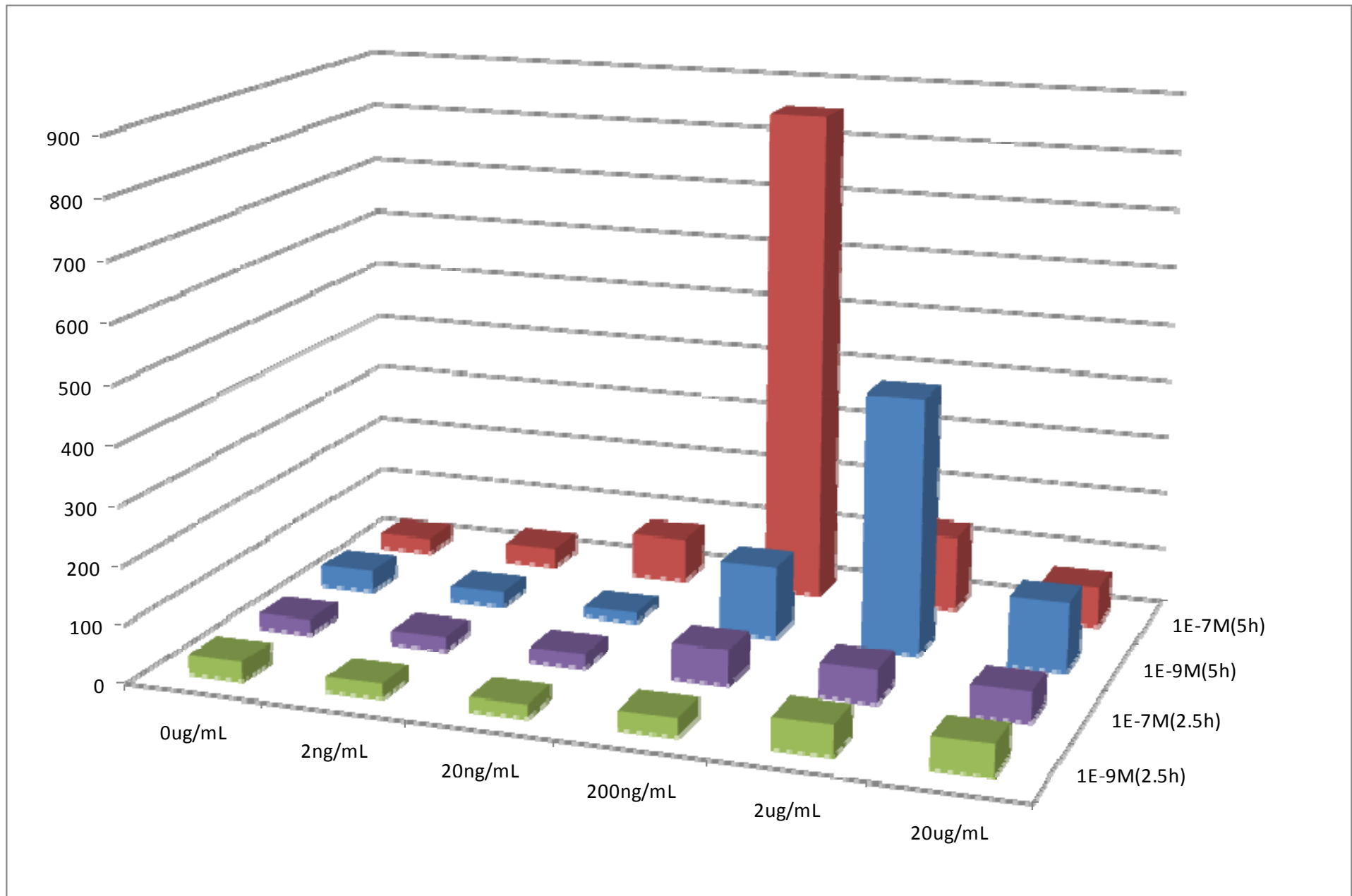

K176070 (9+29)

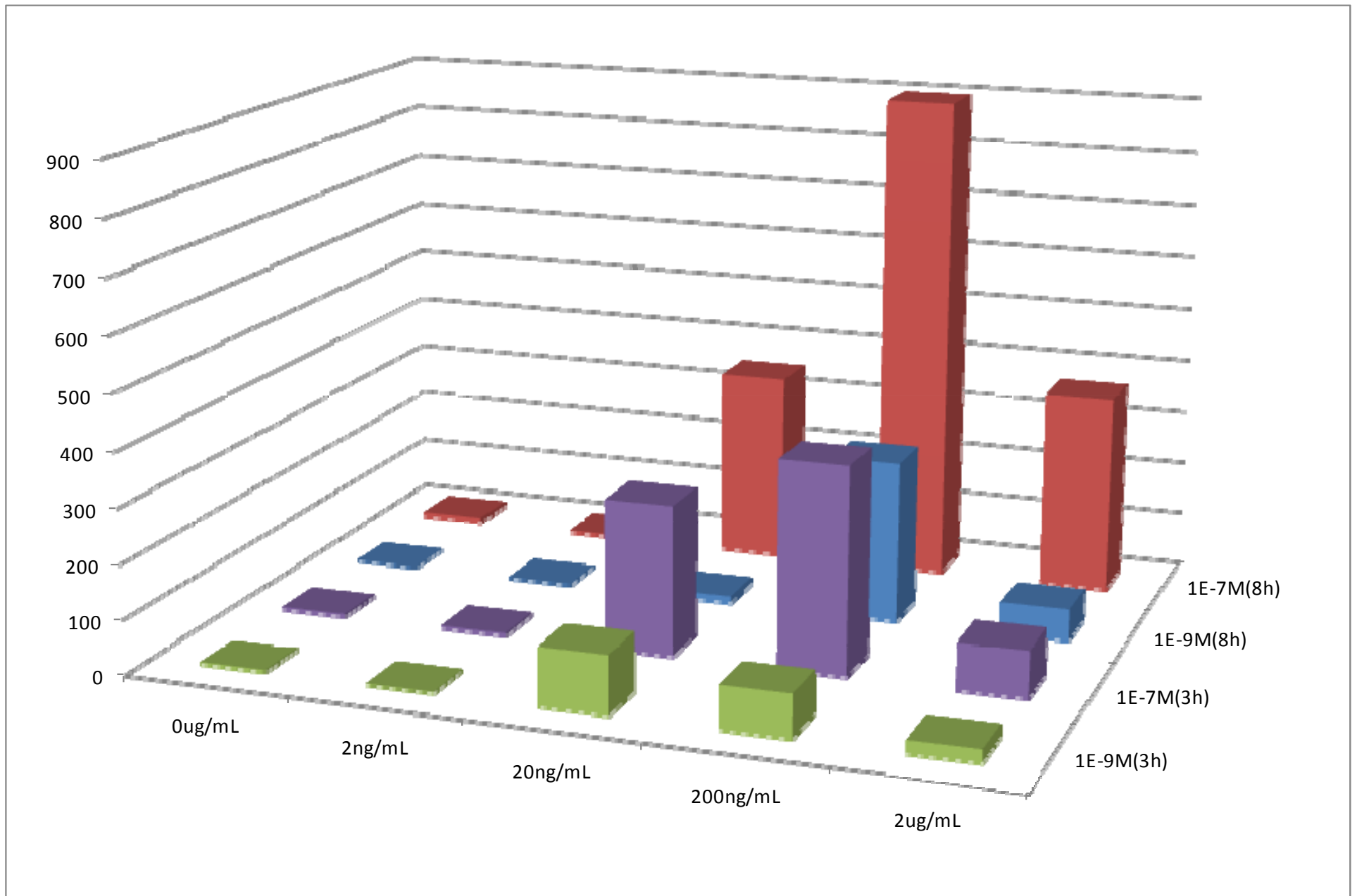

K176071 (9+30)

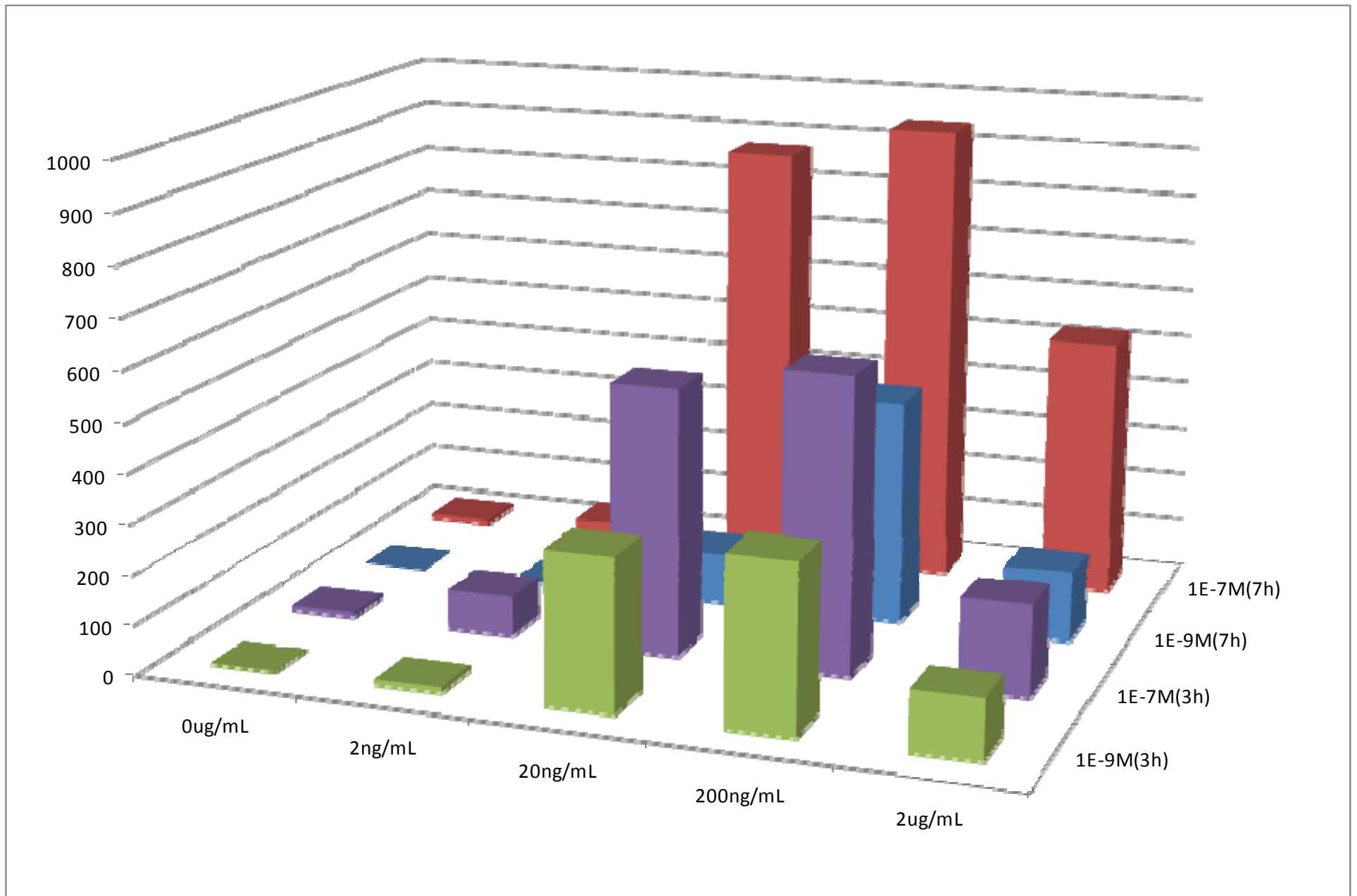

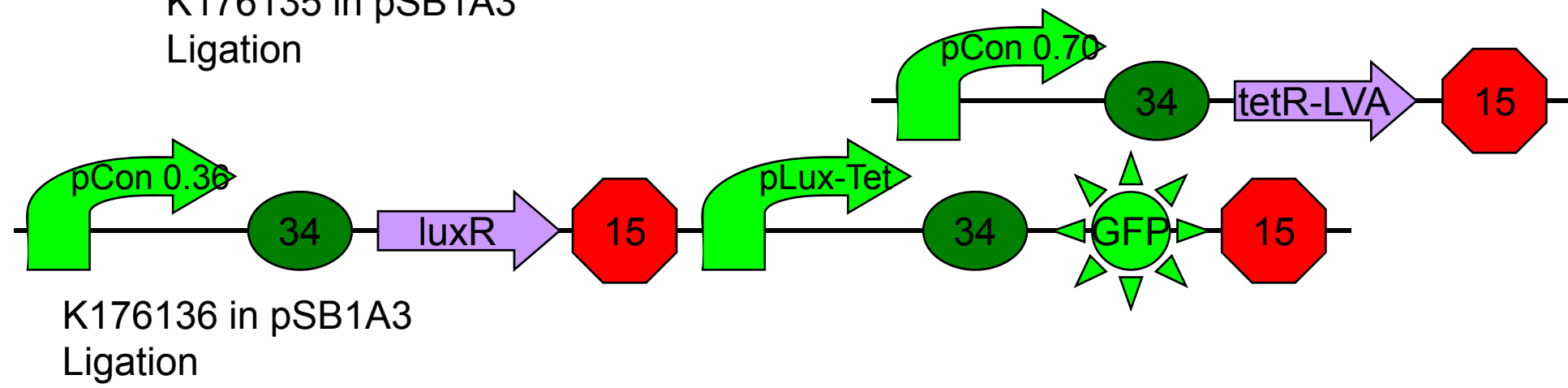
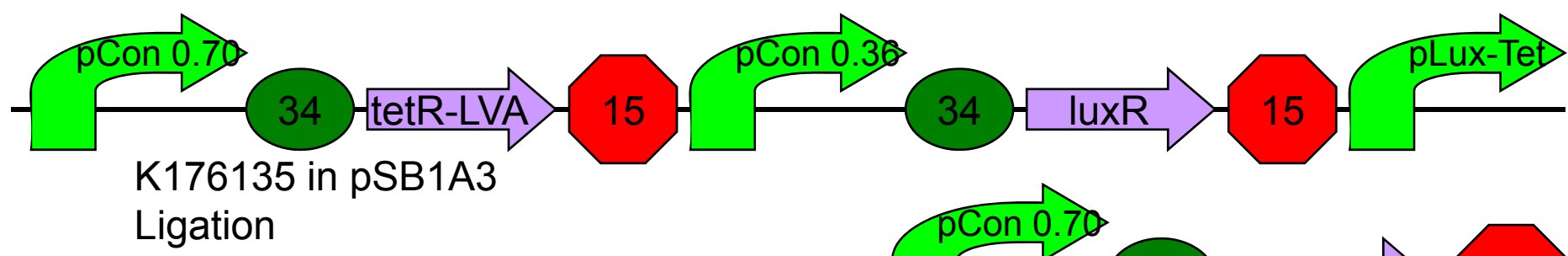
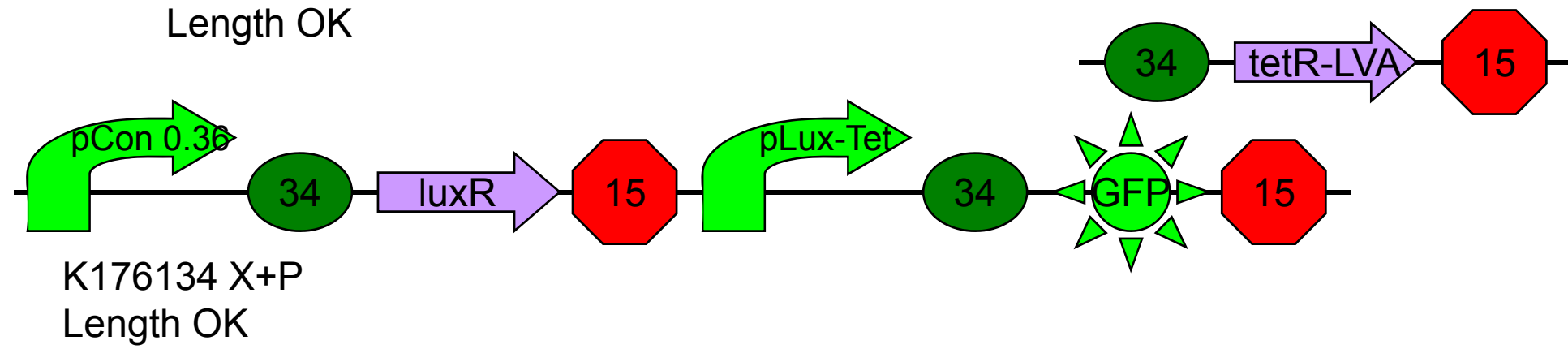
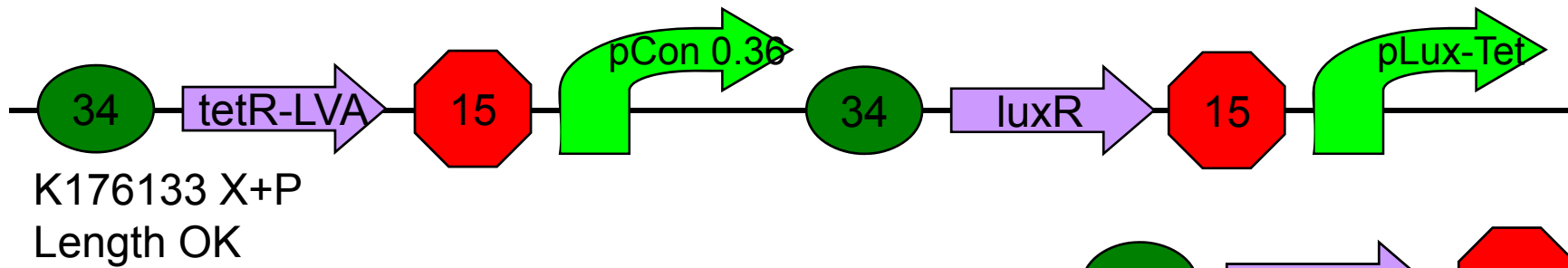

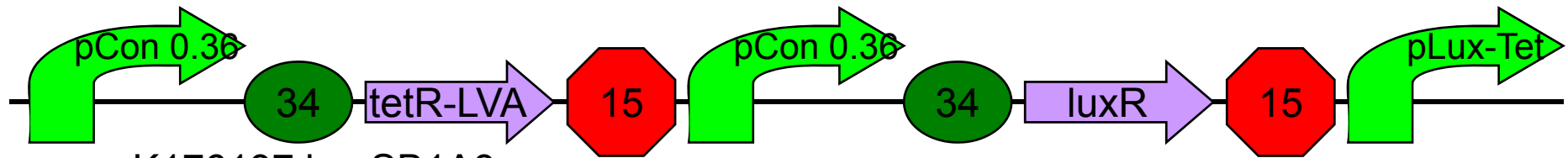

K176137 in pSB1A3
Ligation

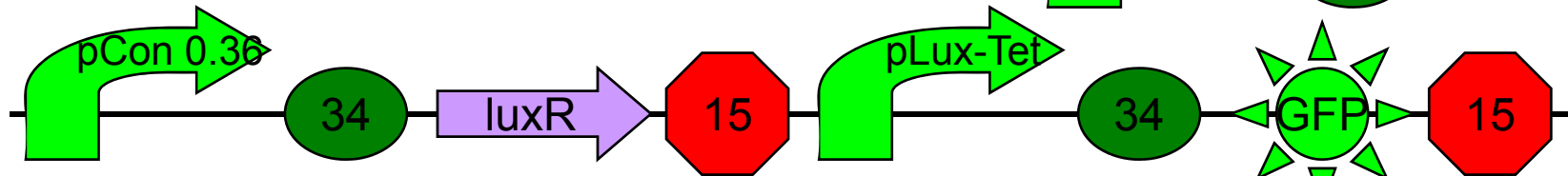
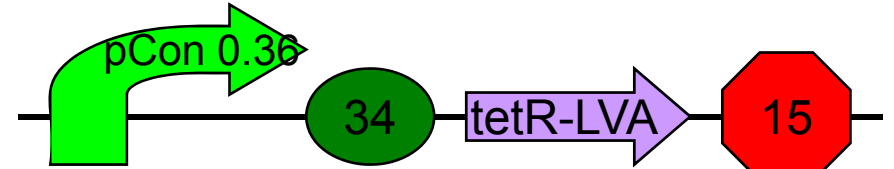

K176138 in pSB1A3
Sequencing

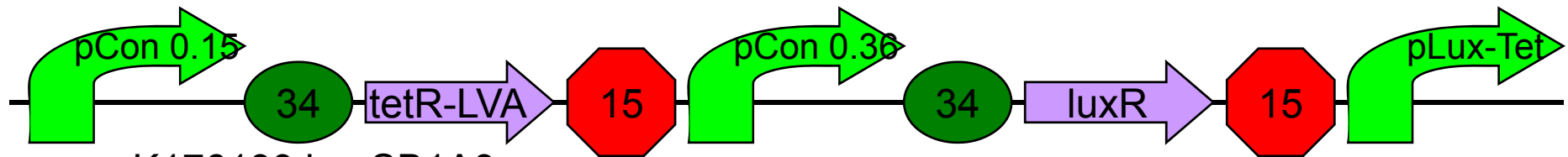

K176139 in pSB1A3
Ligation

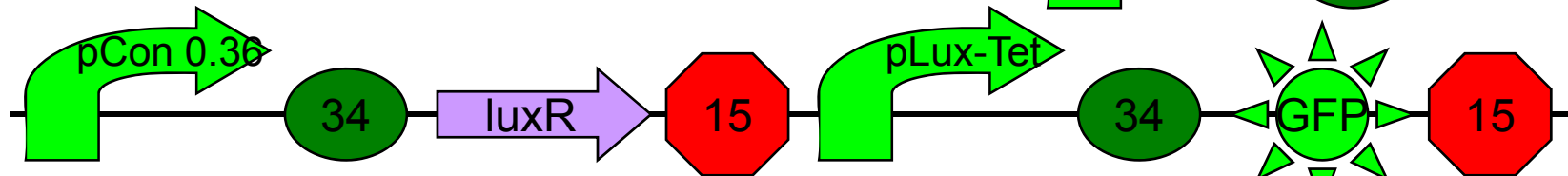
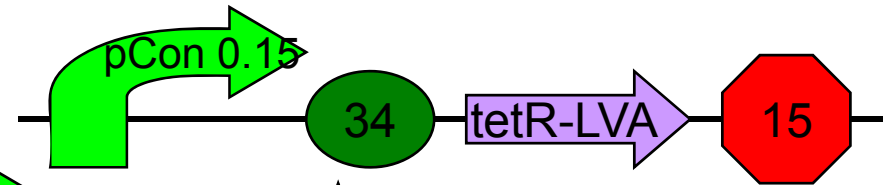

K176140 in pSB1A3
Sequencing

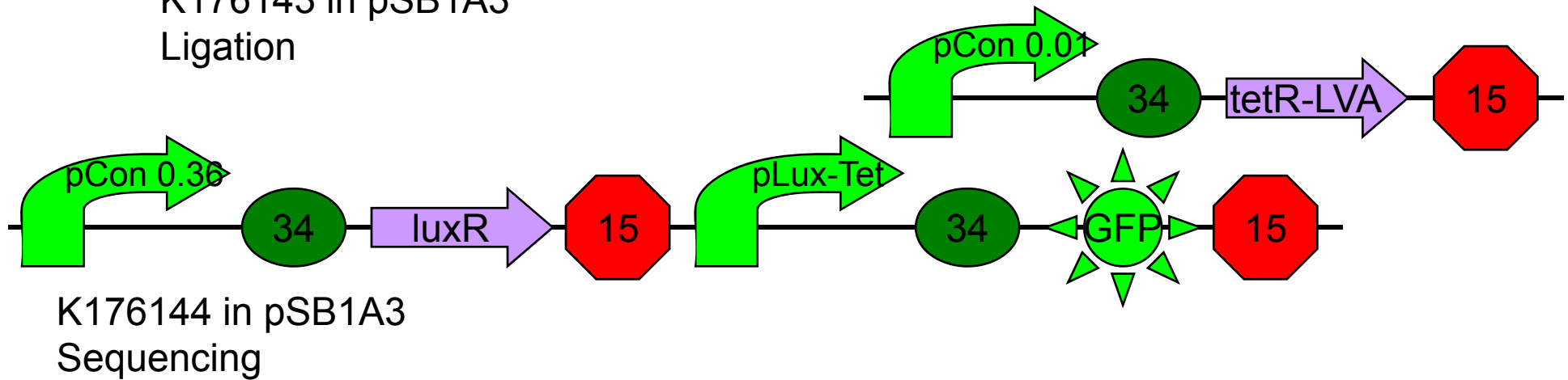
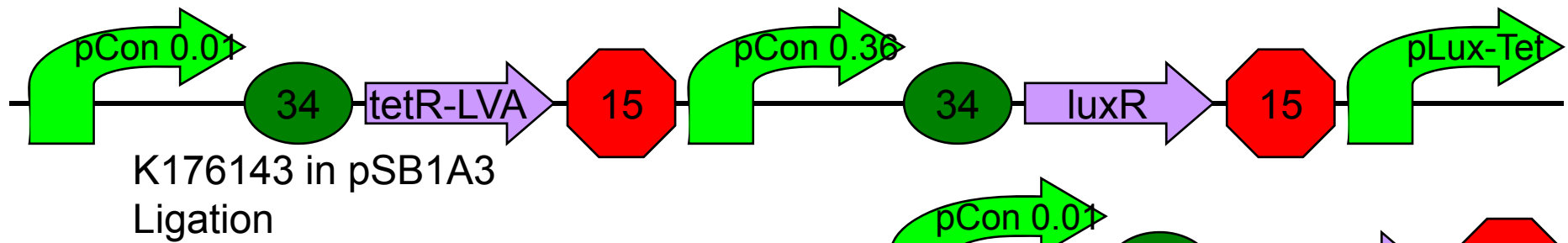
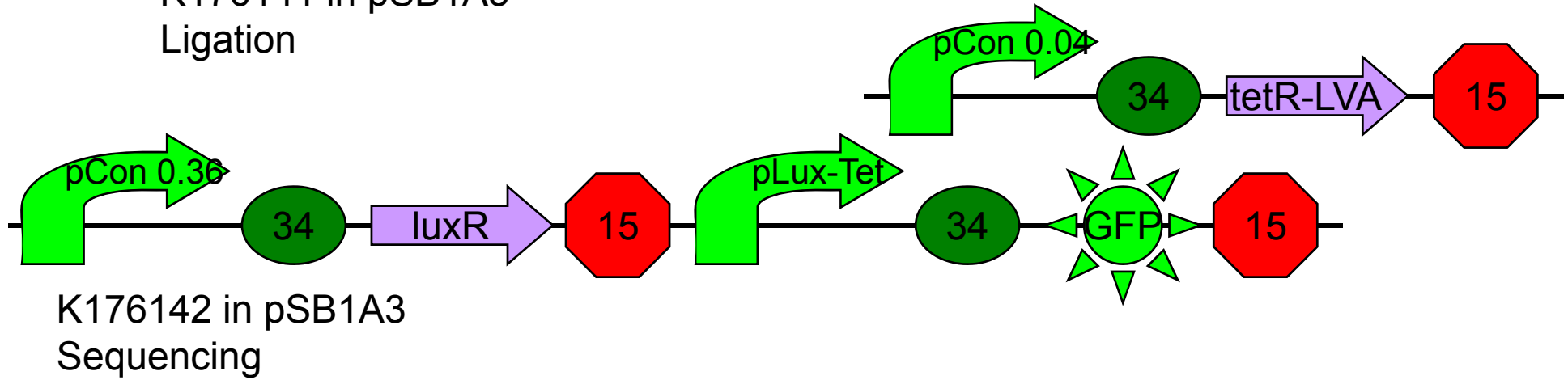
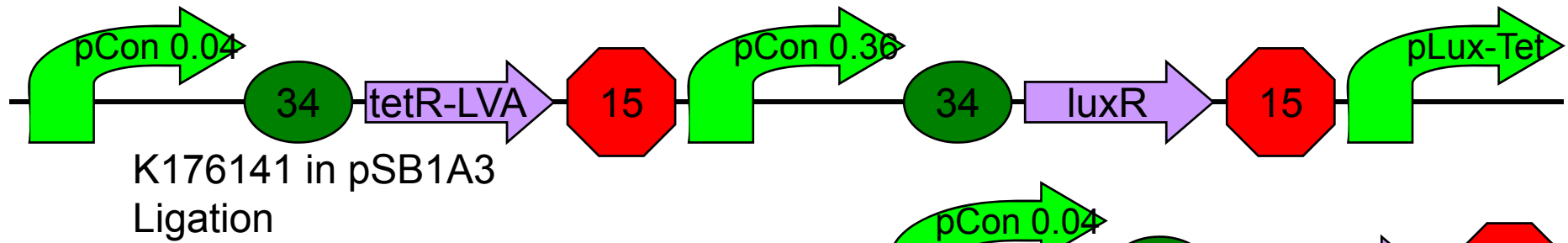

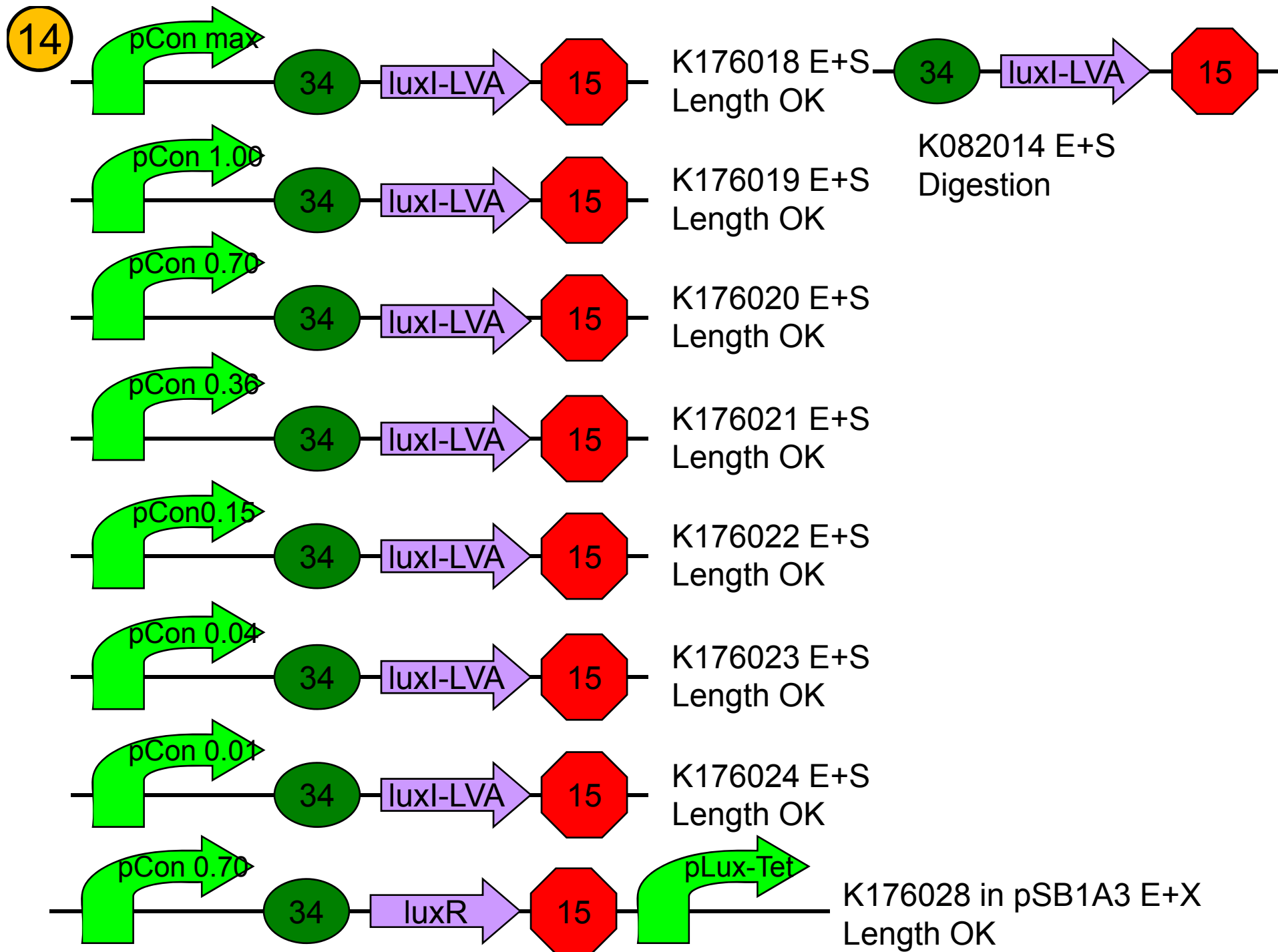

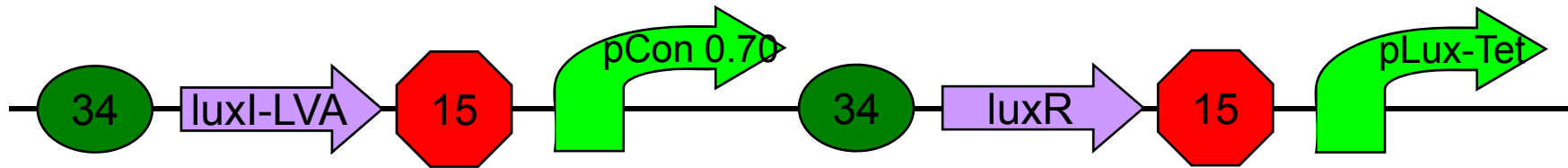

K176080 in pSB1A3
Waiting

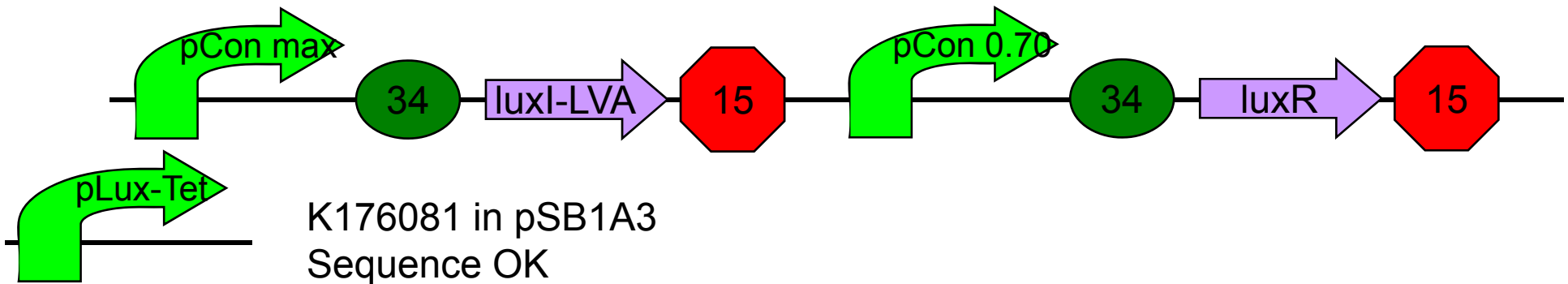

K176081 in pSB1A3
Sequence OK

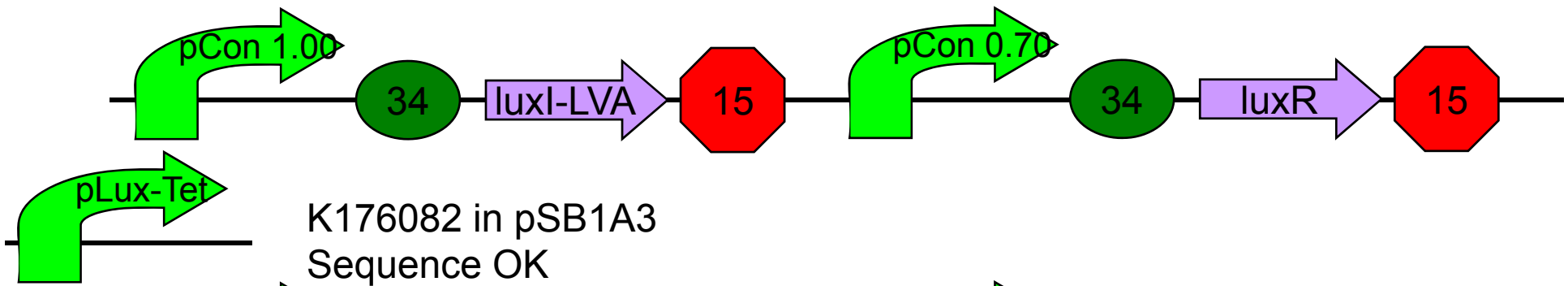

K176082 in pSB1A3
Sequence OK

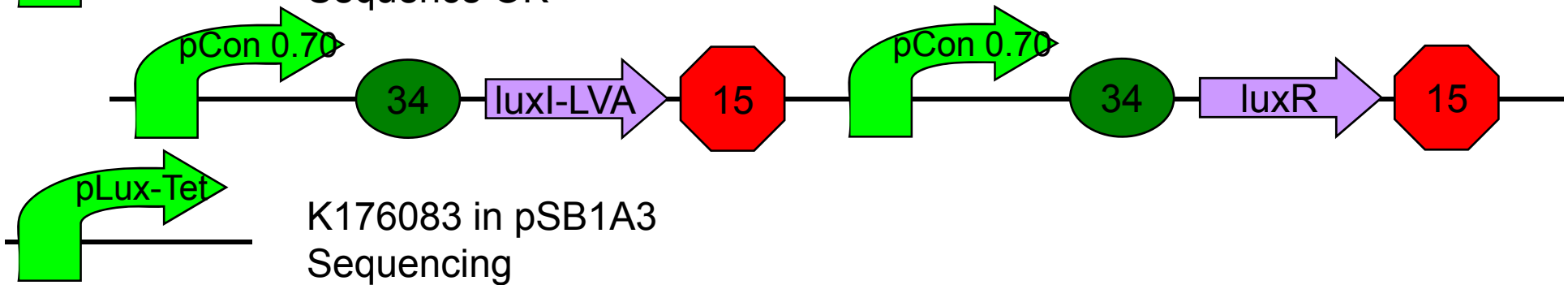

K176083 in pSB1A3
Sequencing

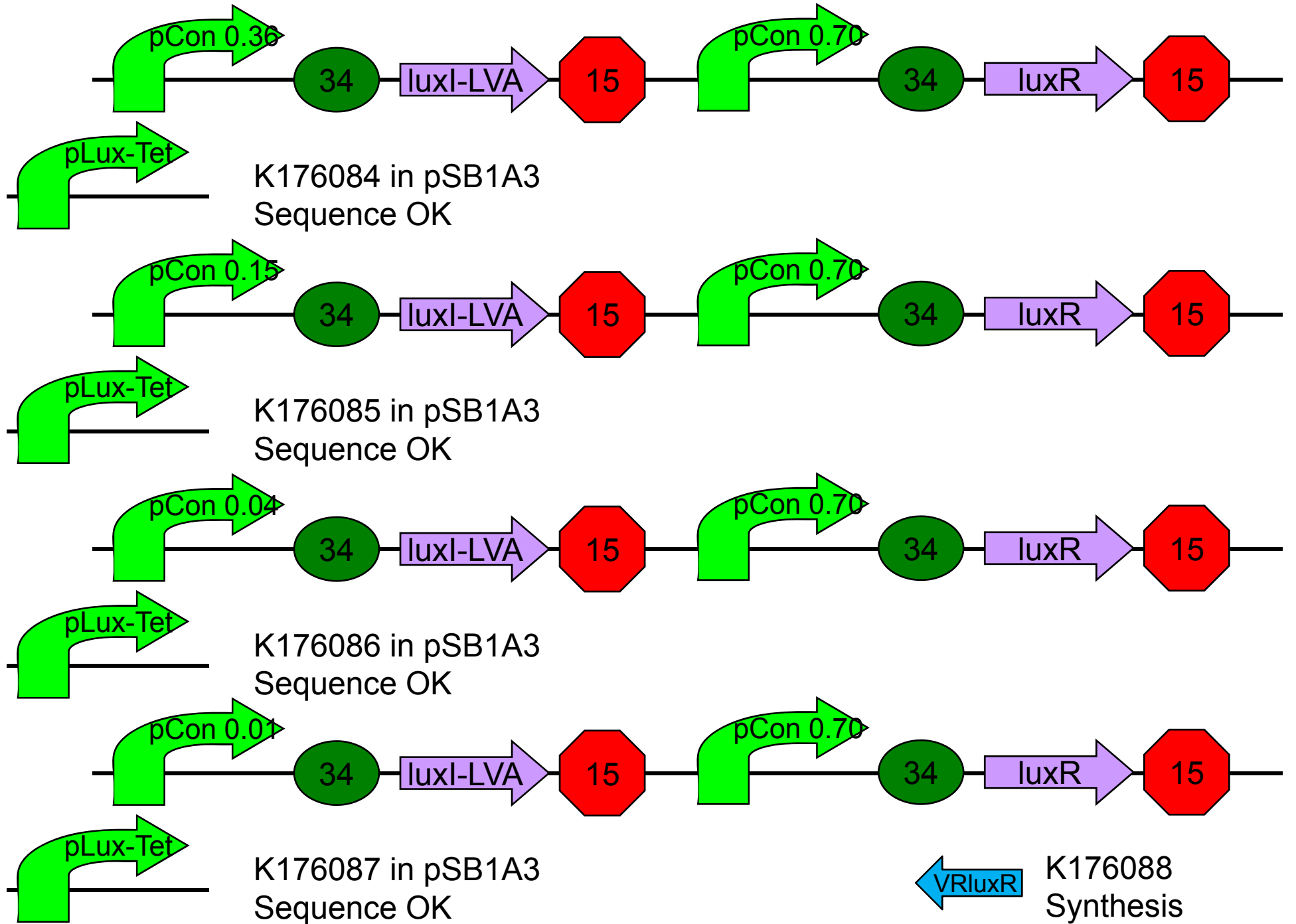

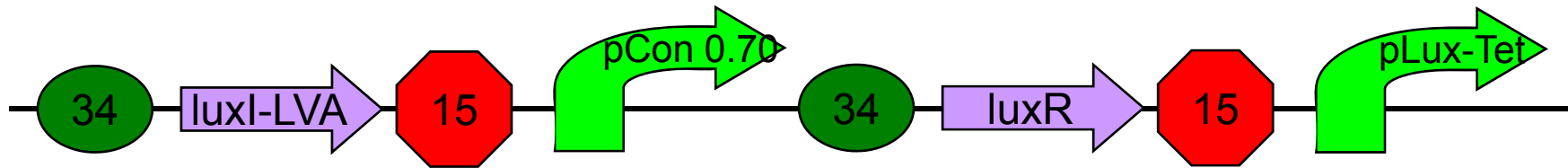

K176080 in pSB1A3 S+P
Waiting

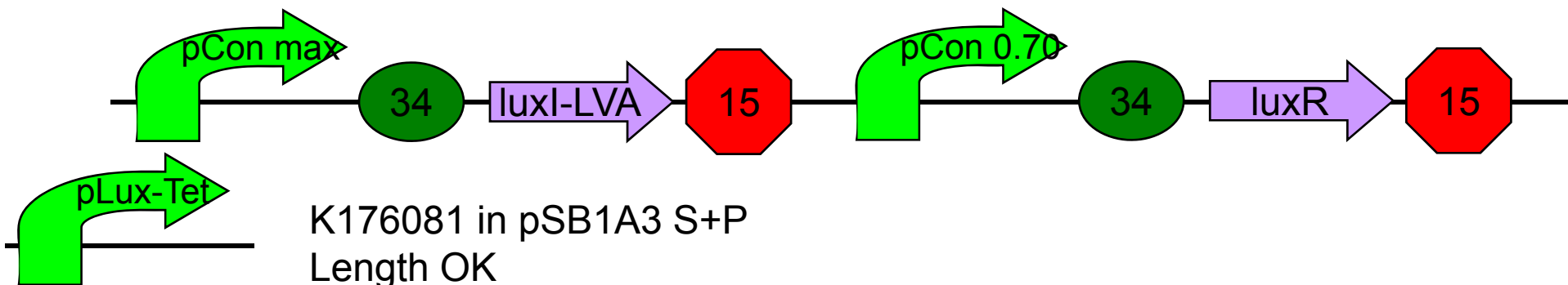

K176081 in pSB1A3 S+P
Length OK

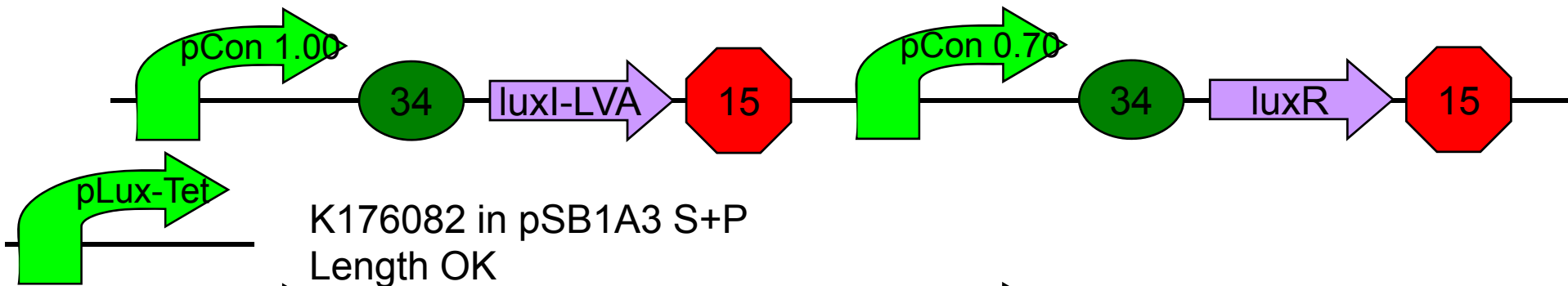

K176082 in pSB1A3 S+P
Length OK

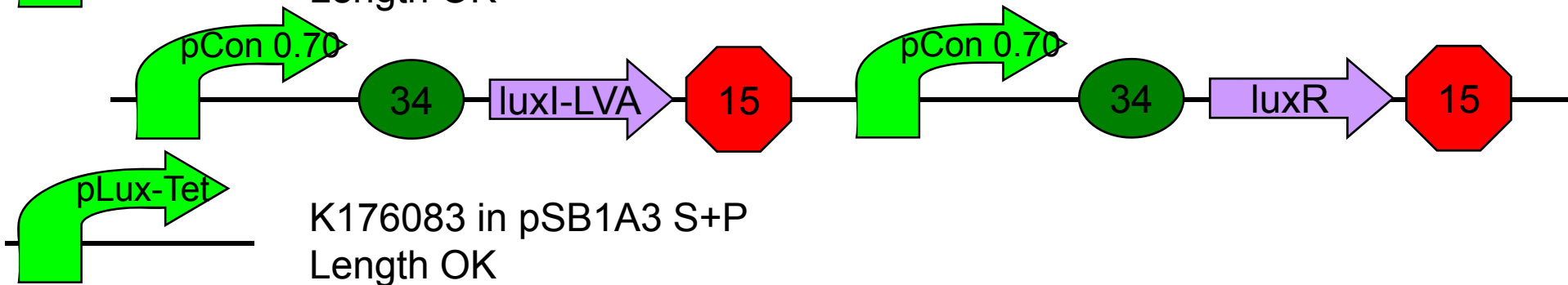

K176083 in pSB1A3 S+P
Length OK

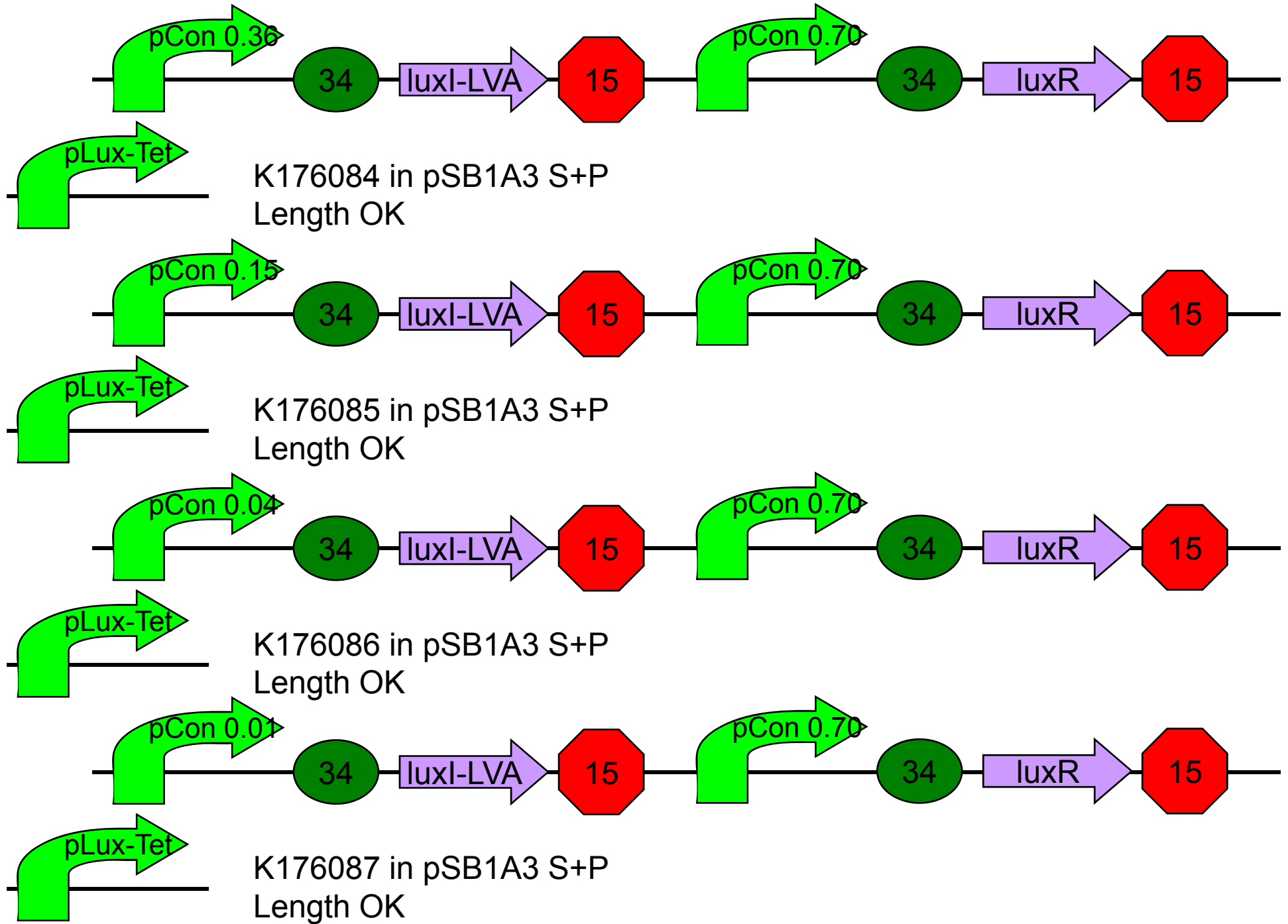

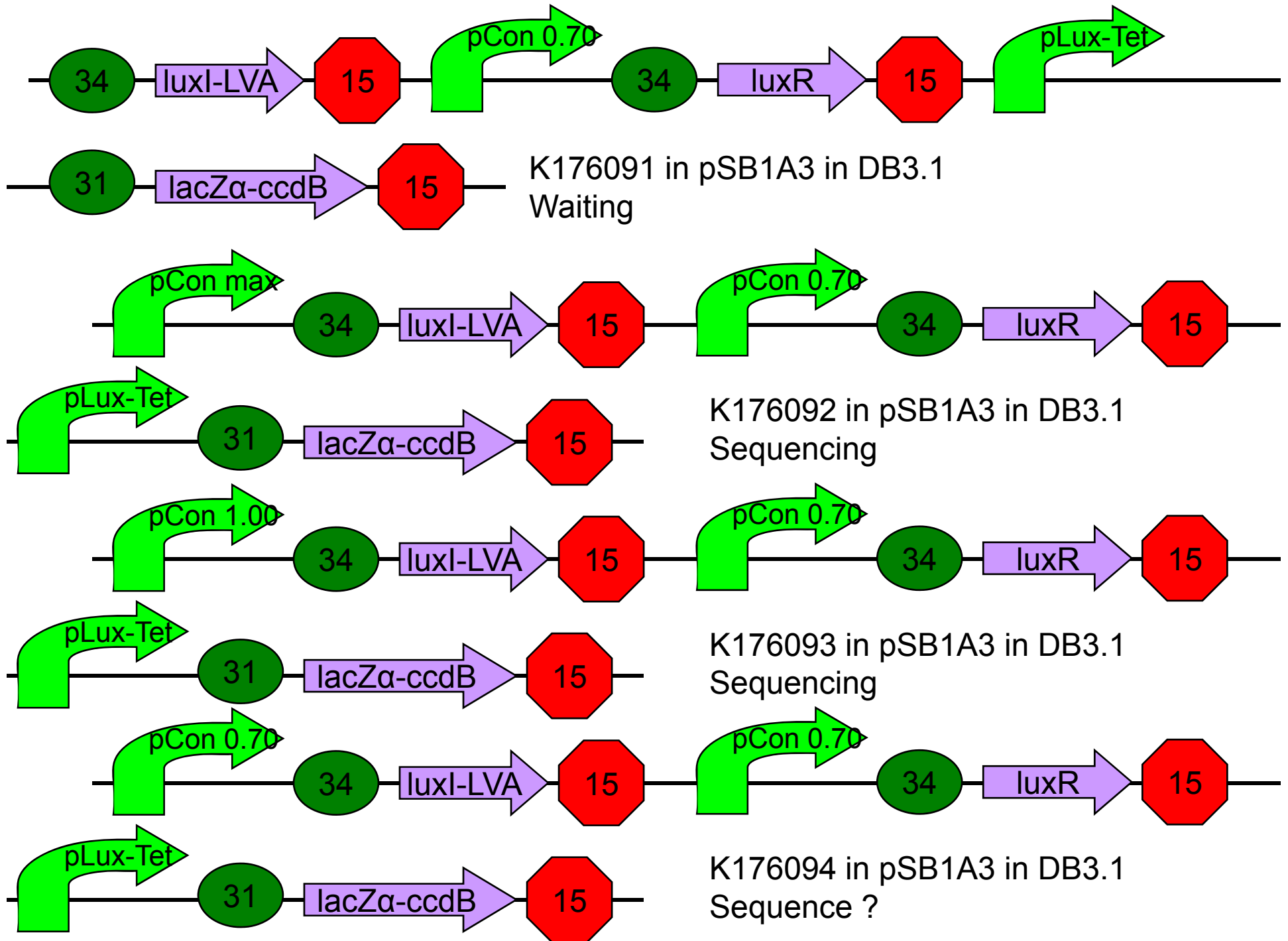

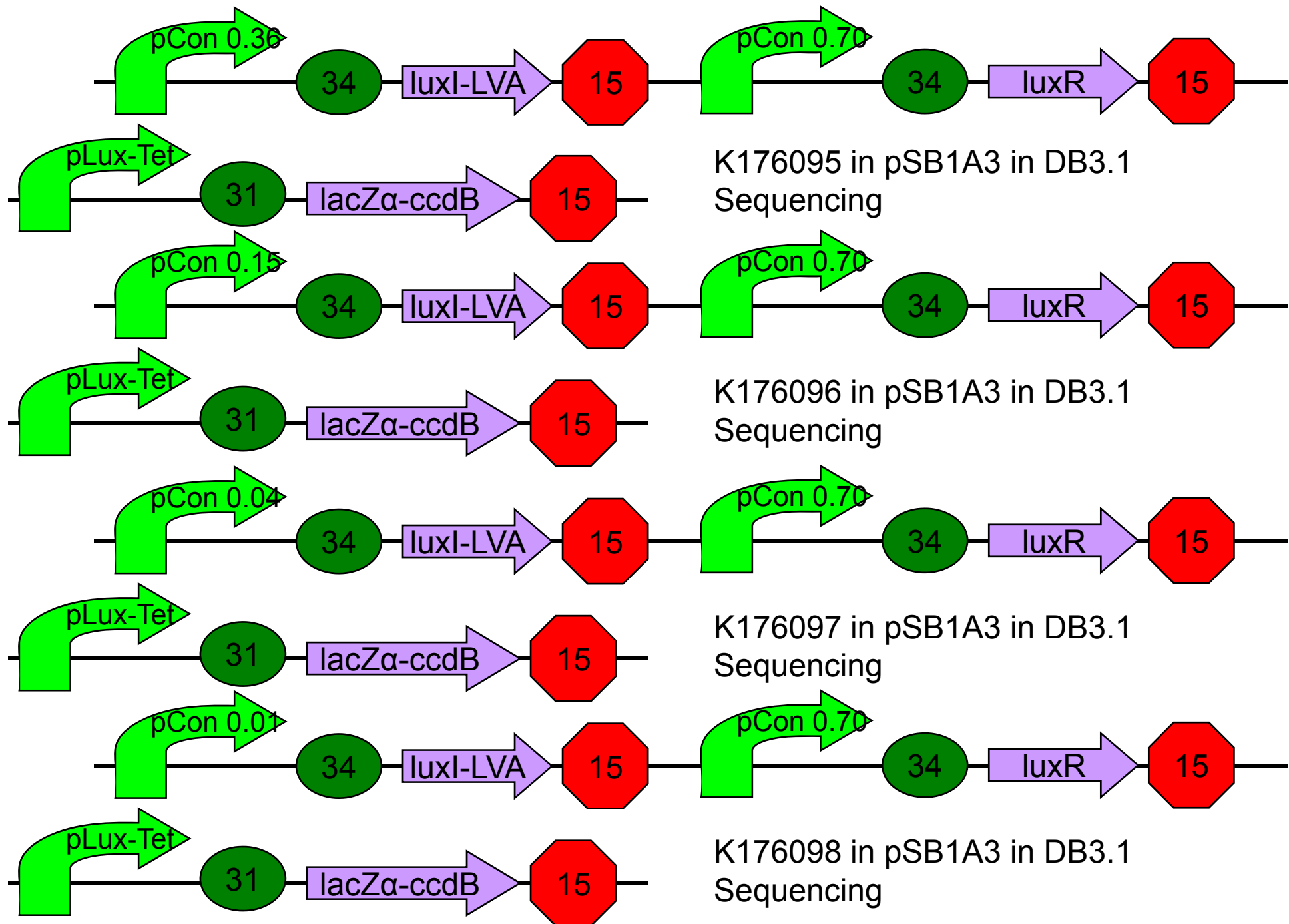

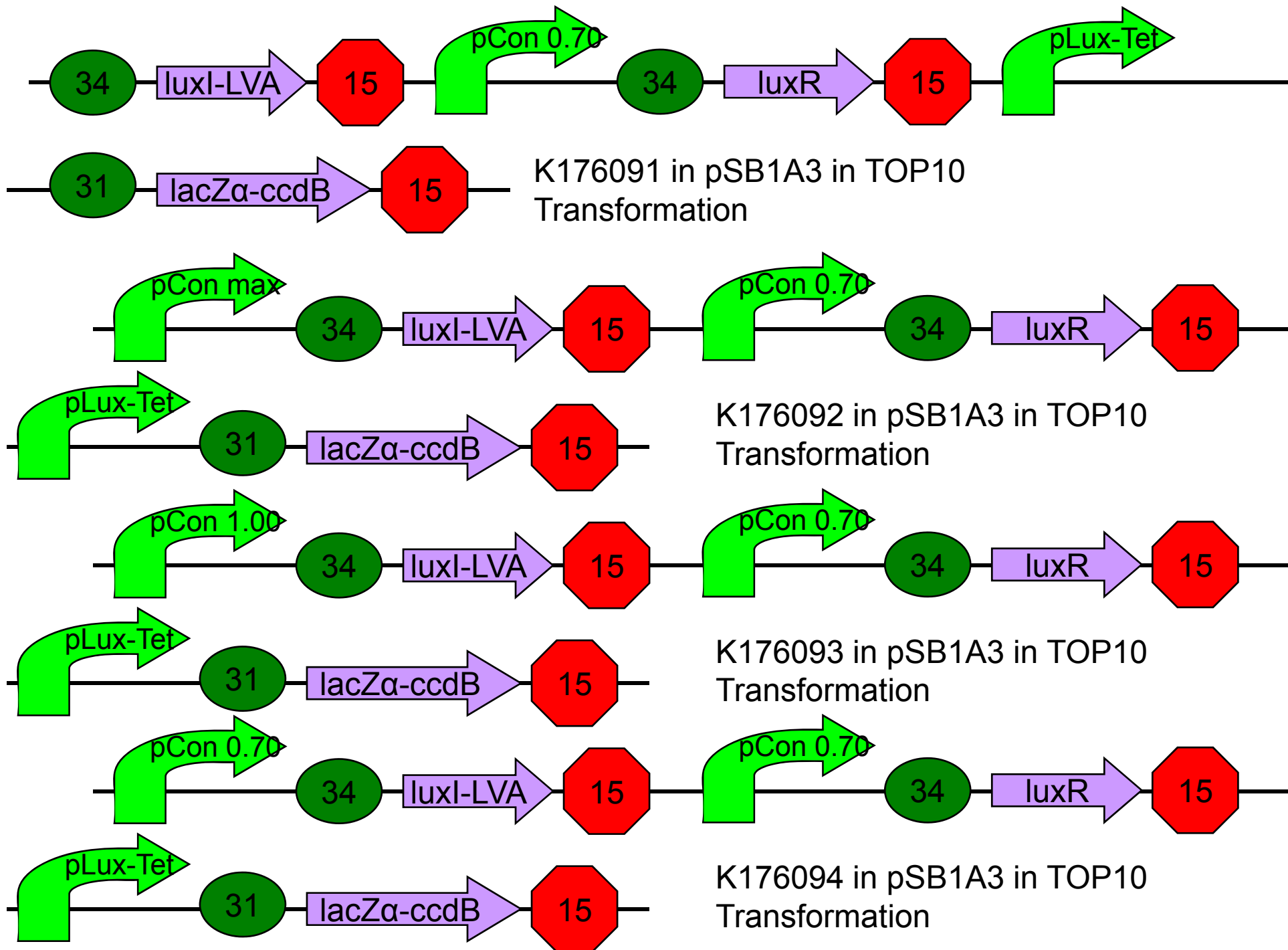

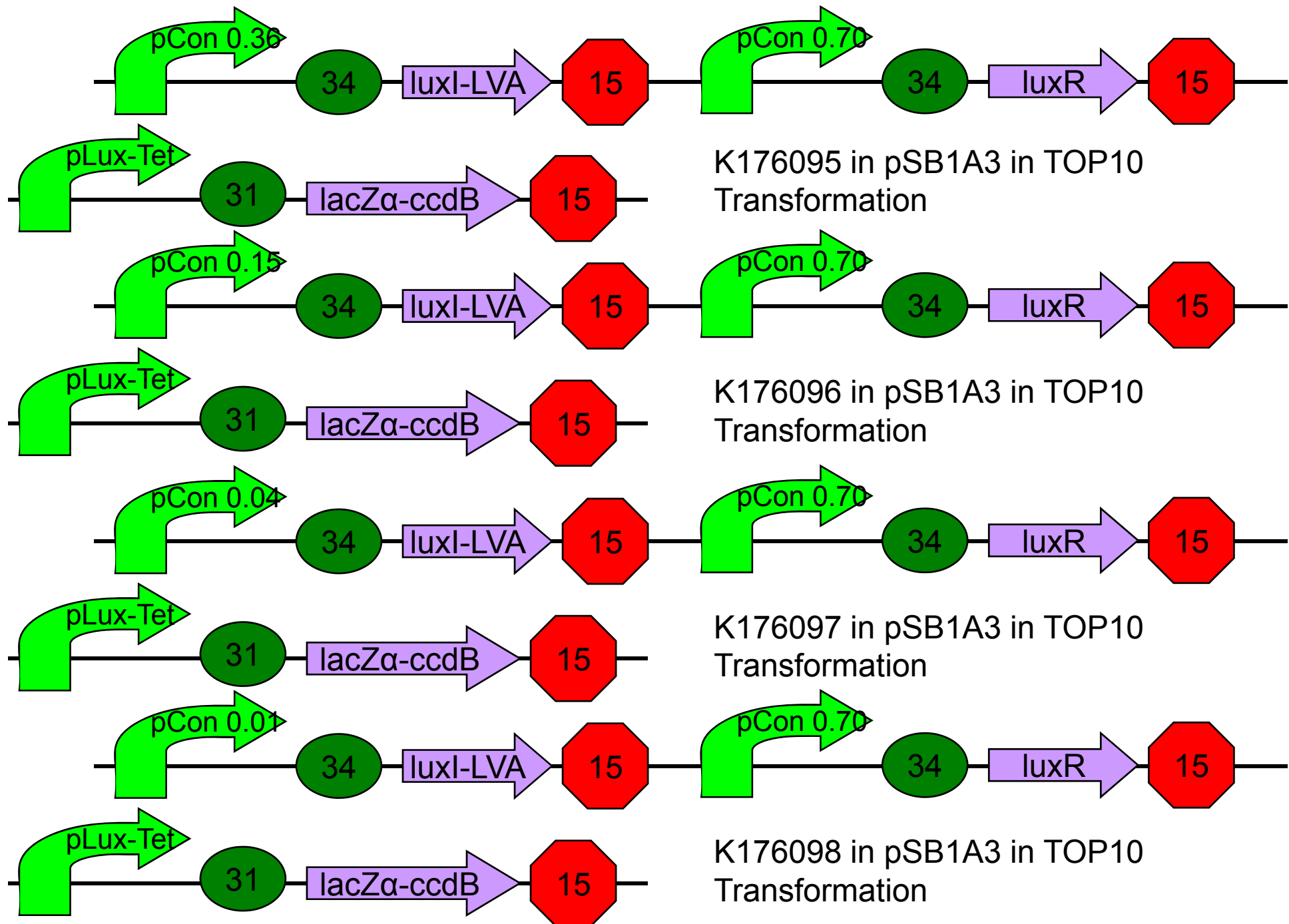

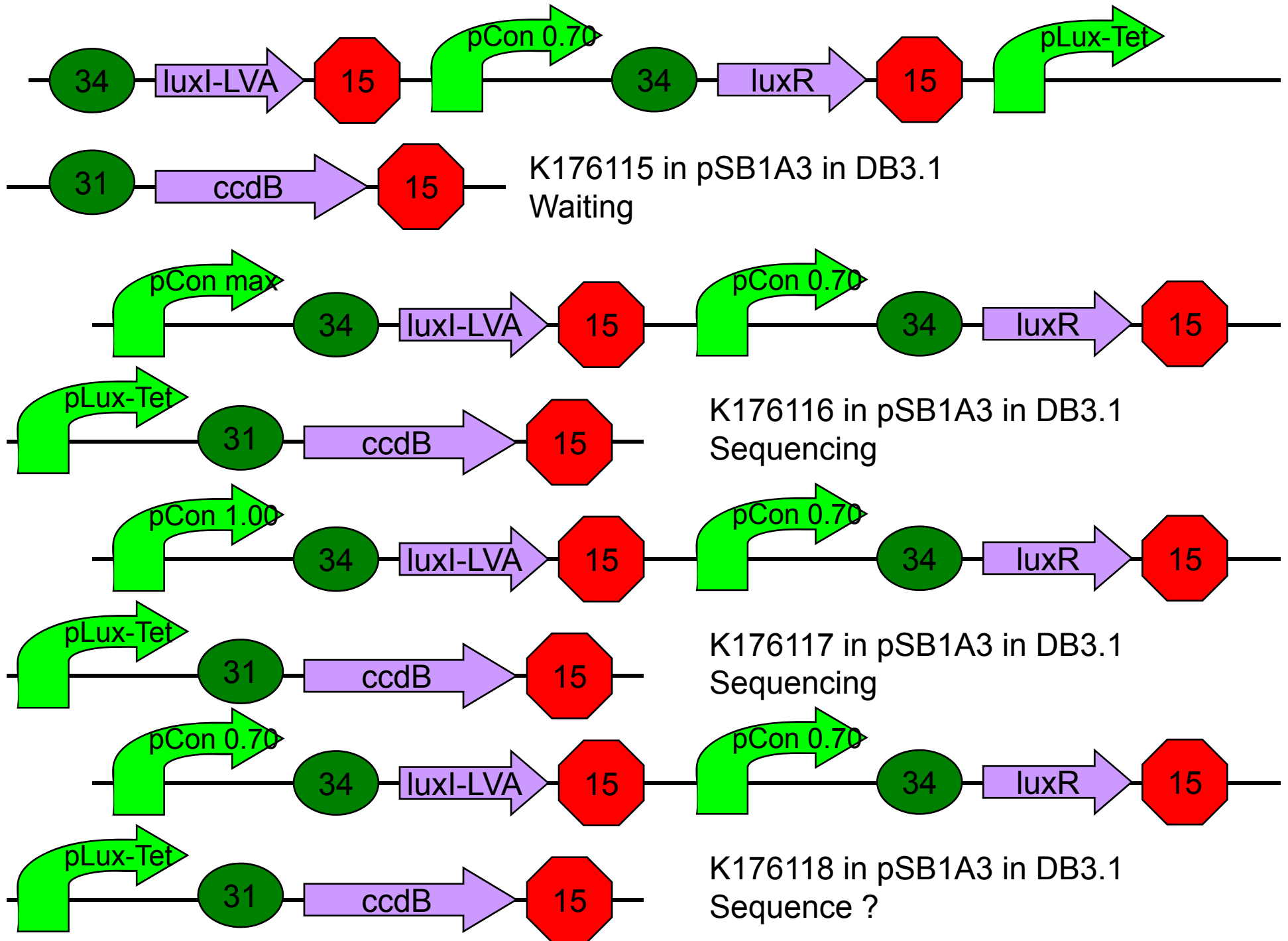

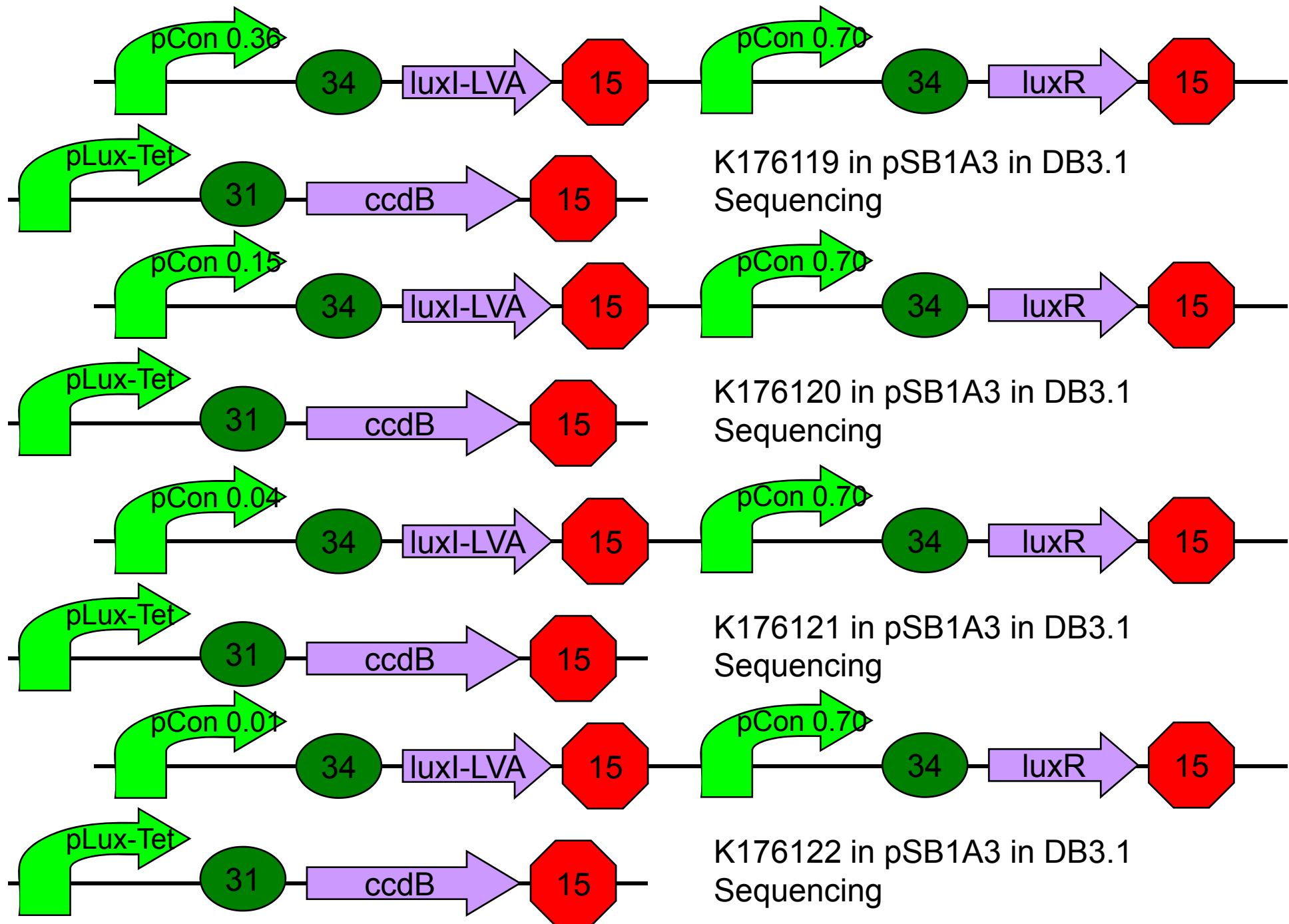

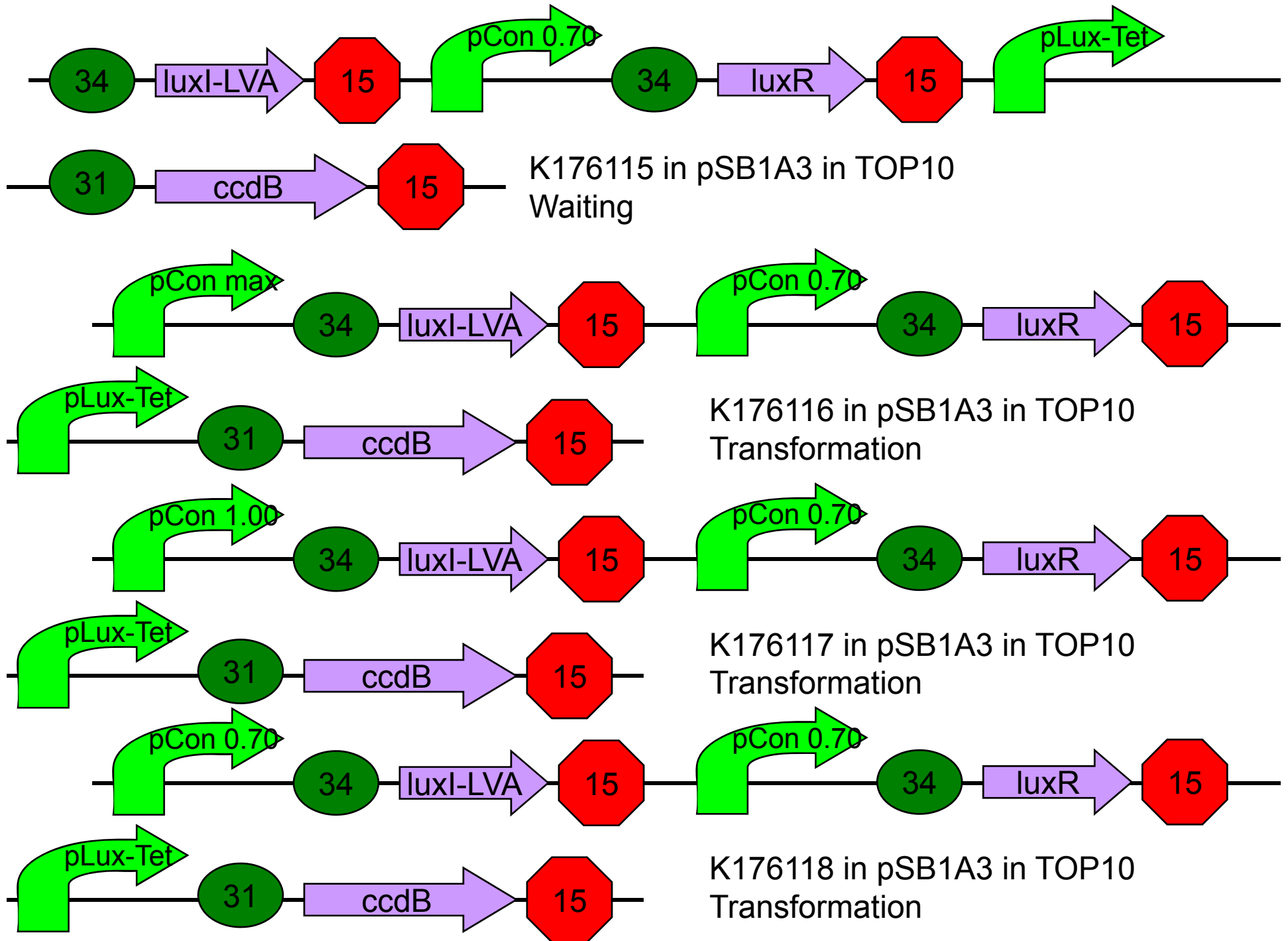

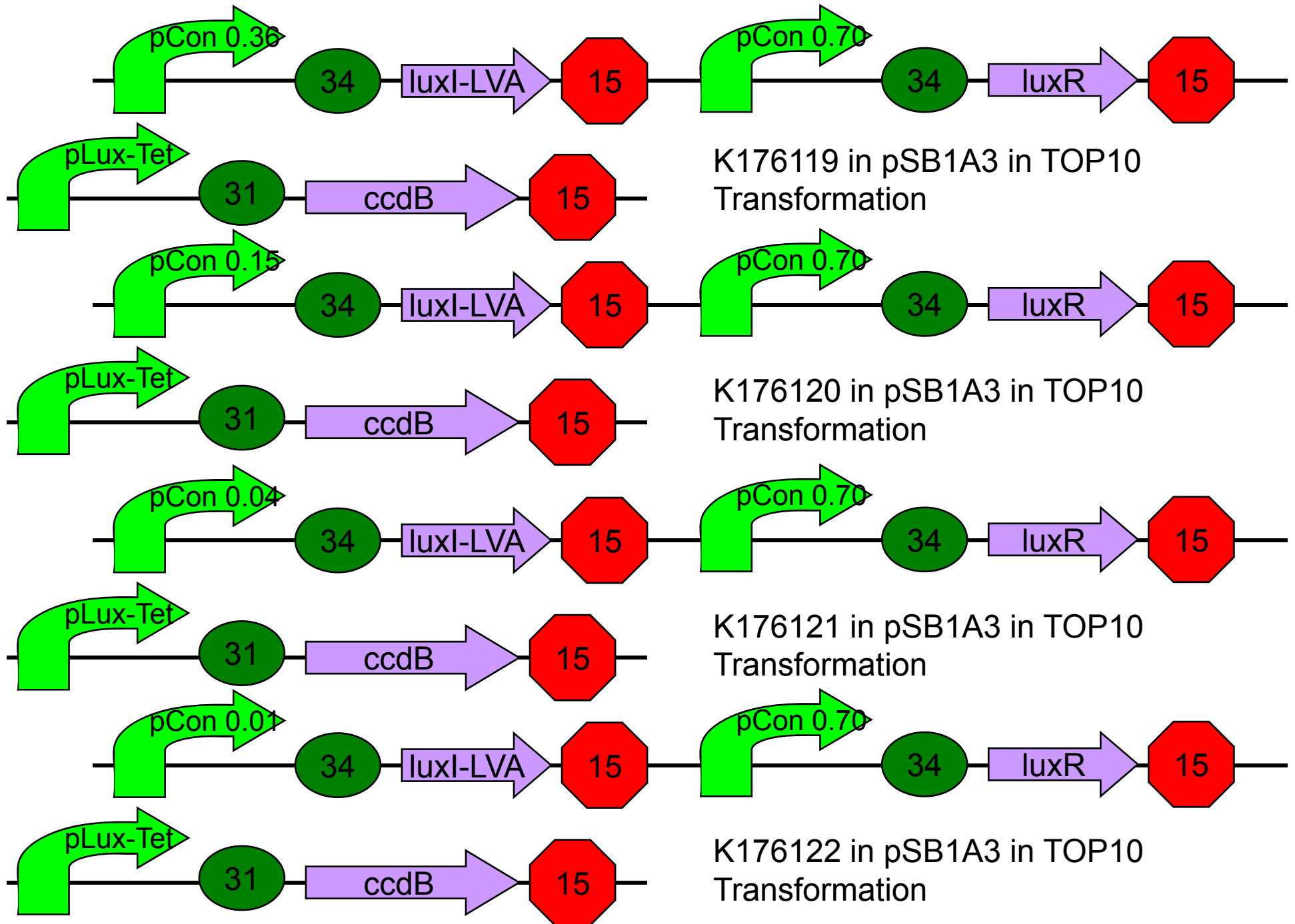

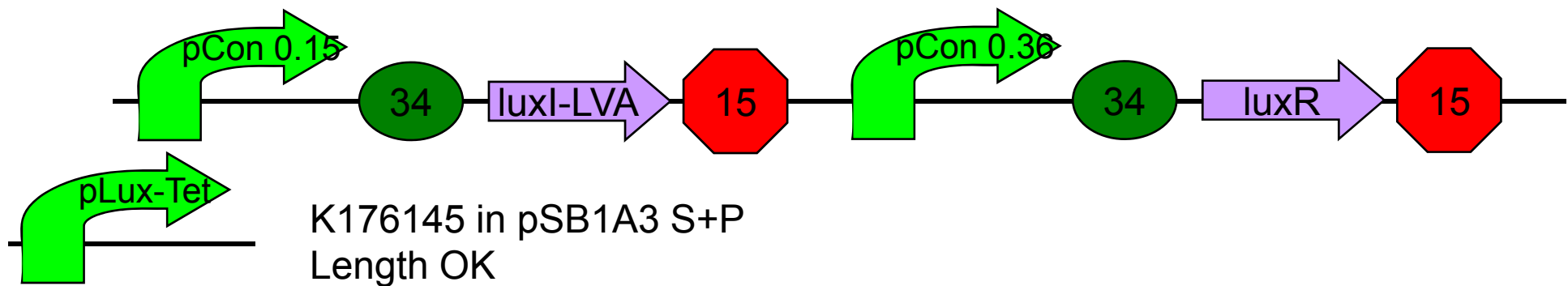
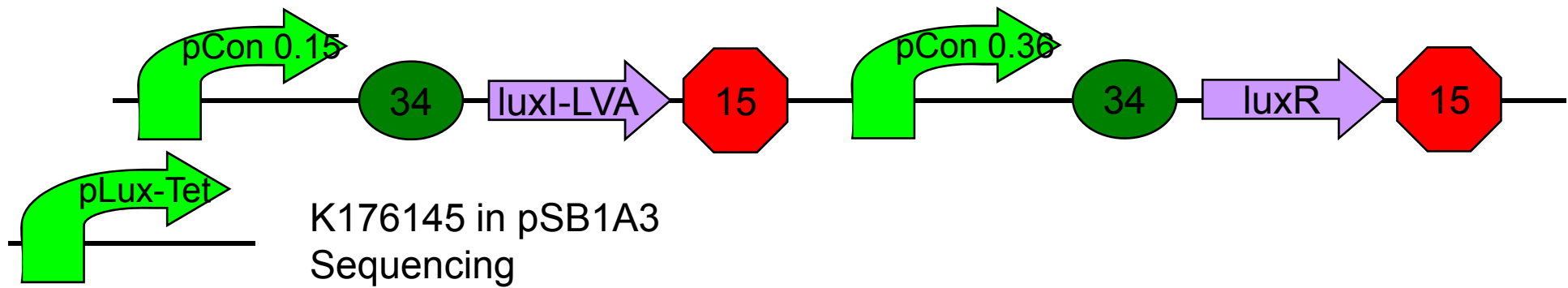
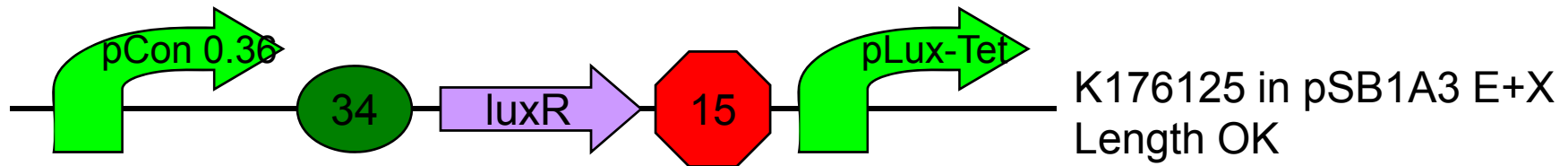

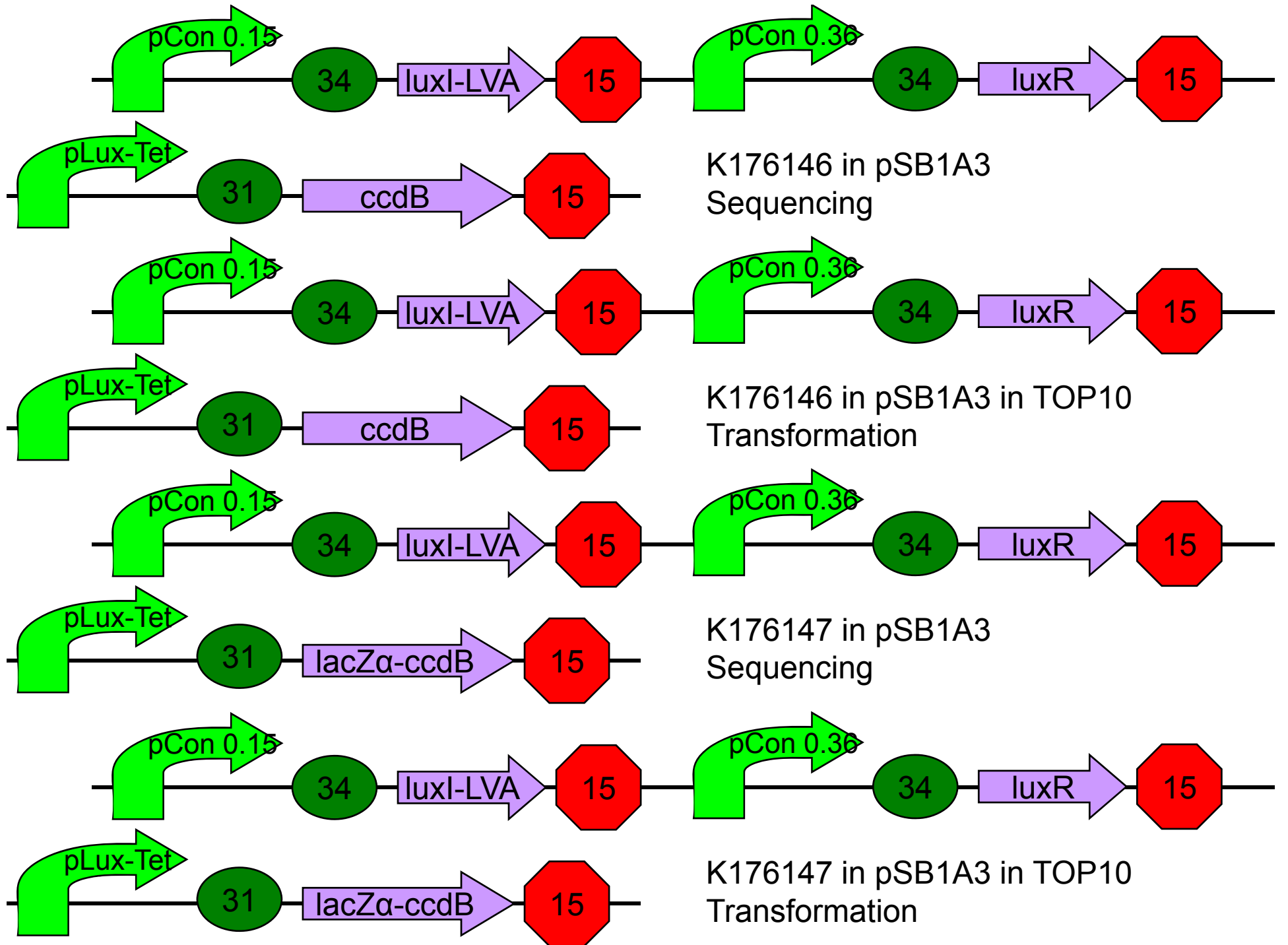

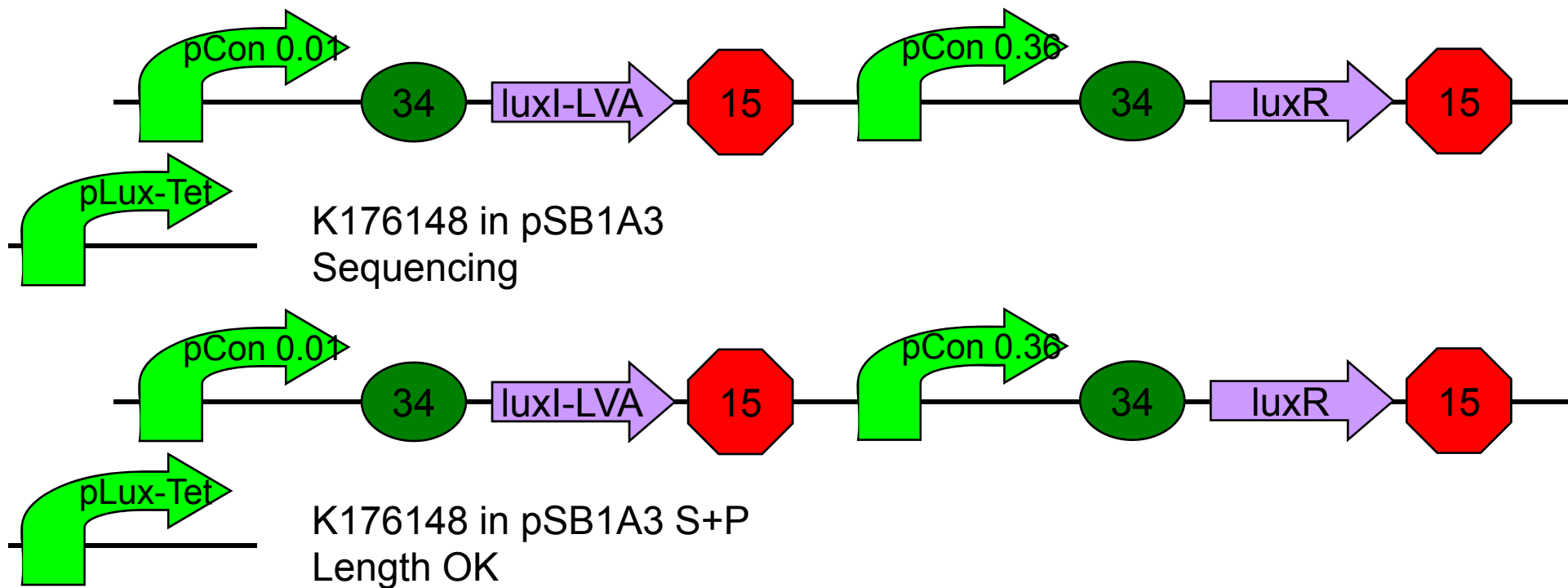

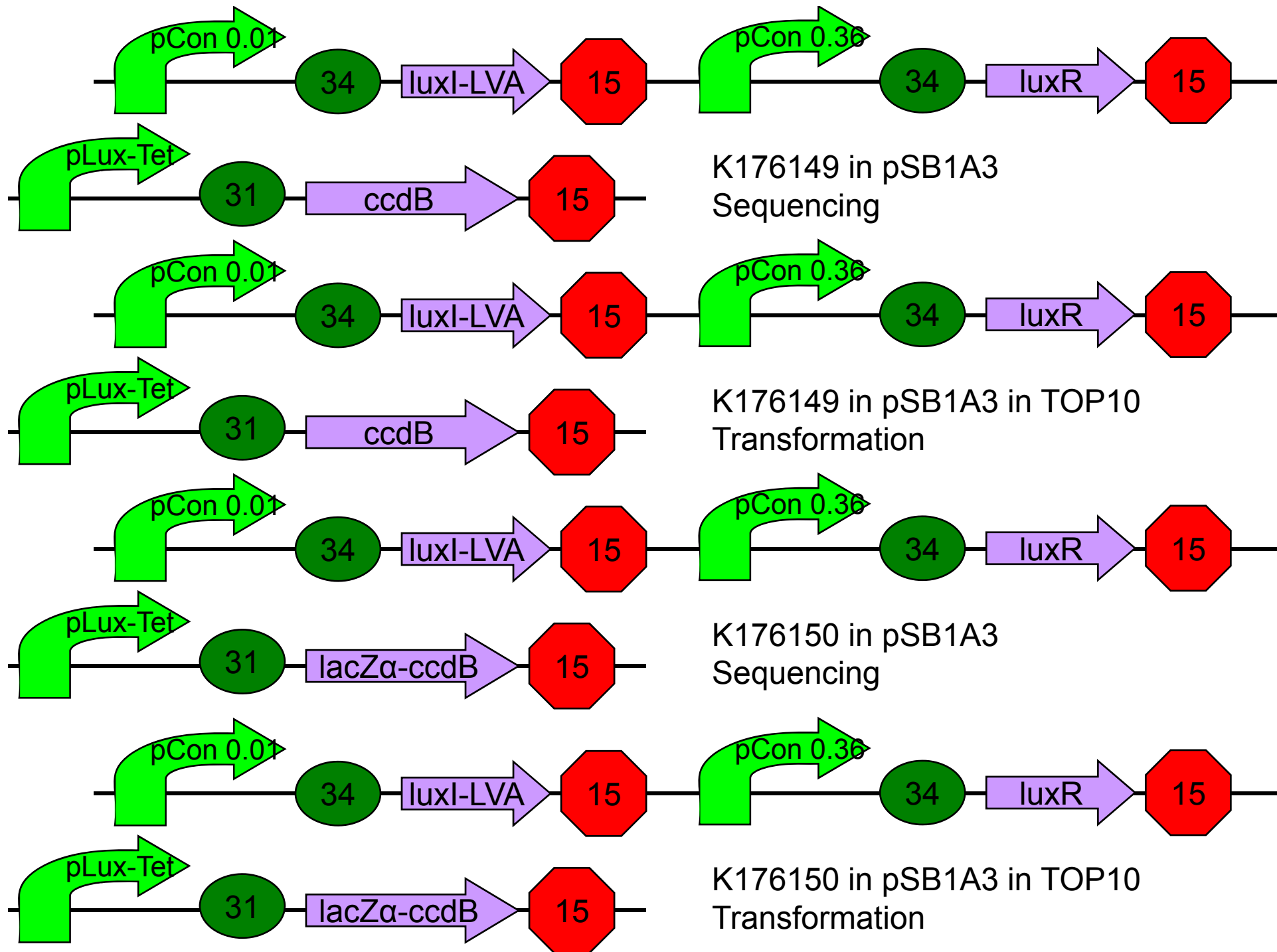

































15

	K176037 E+S Synthesis OK		K176037 in pSB1A3 Sequencing		K176047 Synthesis OK
	K176038 E+S Synthesis OK		K176038 in pSB1A3 Sequencing		K176048 Synthesis OK
	K176039 E+S Synthesis OK		K176039 in pSB1A3 Sequencing		K176049 Synthesis OK
	K176040 E+S Synthesis OK		K176040 in pSB1A3 Sequencing		K176050 Synthesis OK
	K176041 E+S Synthesis OK		K176041 in pSB1A3 Sequencing		K176051 Synthesis OK
	K176042 E+S Synthesis OK		K176042 in pSB1A3 Sequencing		K176052 Synthesis OK
	K176043 E+S Synthesis OK		K176043 in pSB1A3 Sequencing		K176053 Synthesis OK
	K176044 E+S Synthesis OK		K176044 in pSB1A3 Sequencing		K176054 Synthesis OK
	K176045 E+S Synthesis OK		K176045 in pSB1A3 Sequencing		K176055 Synthesis OK
	K176046 E+S Synthesis OK		K176046 in pSB1A3 Sequencing		K176056 Synthesis OK
—	pSB1A3 E+S Length OK				

16

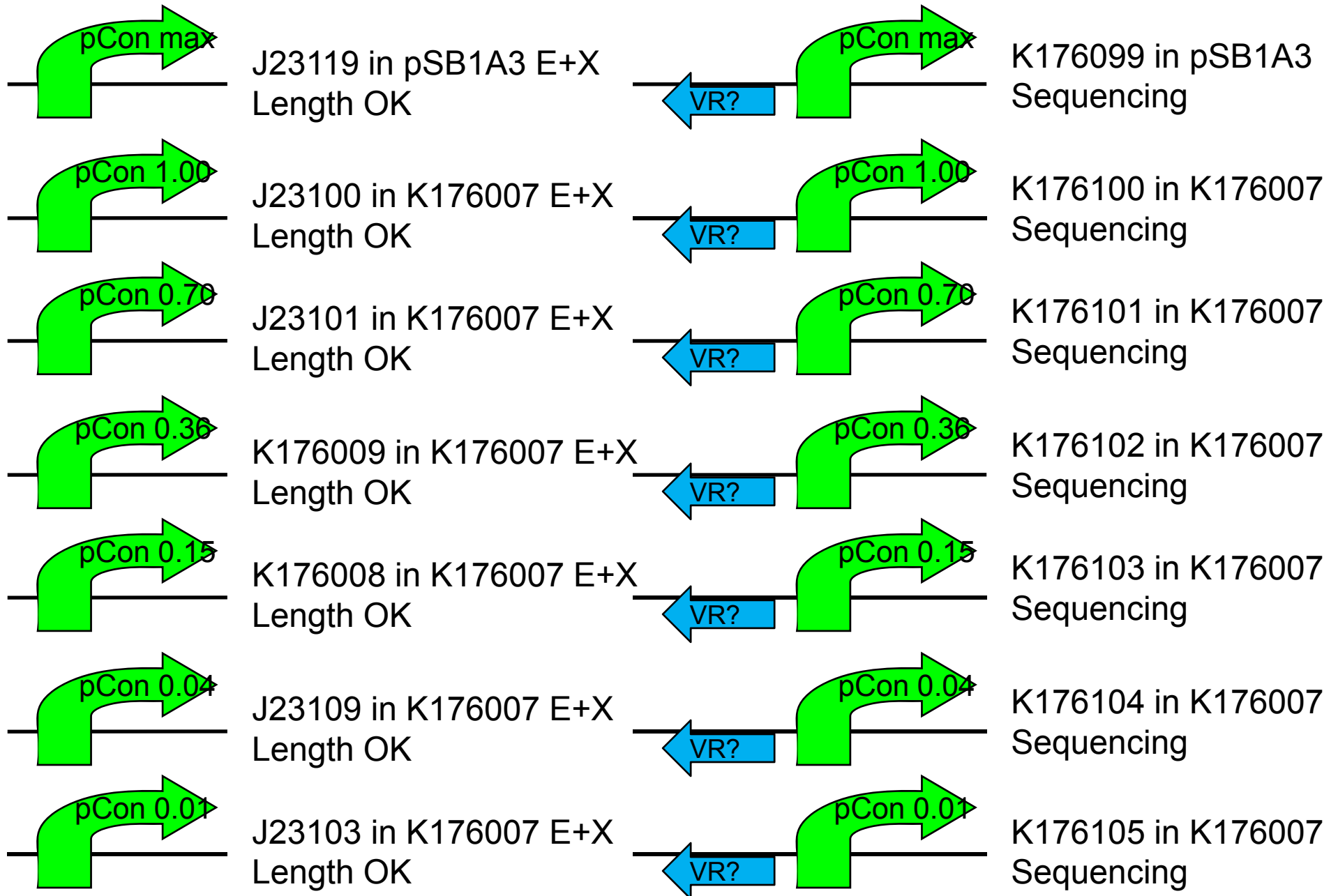

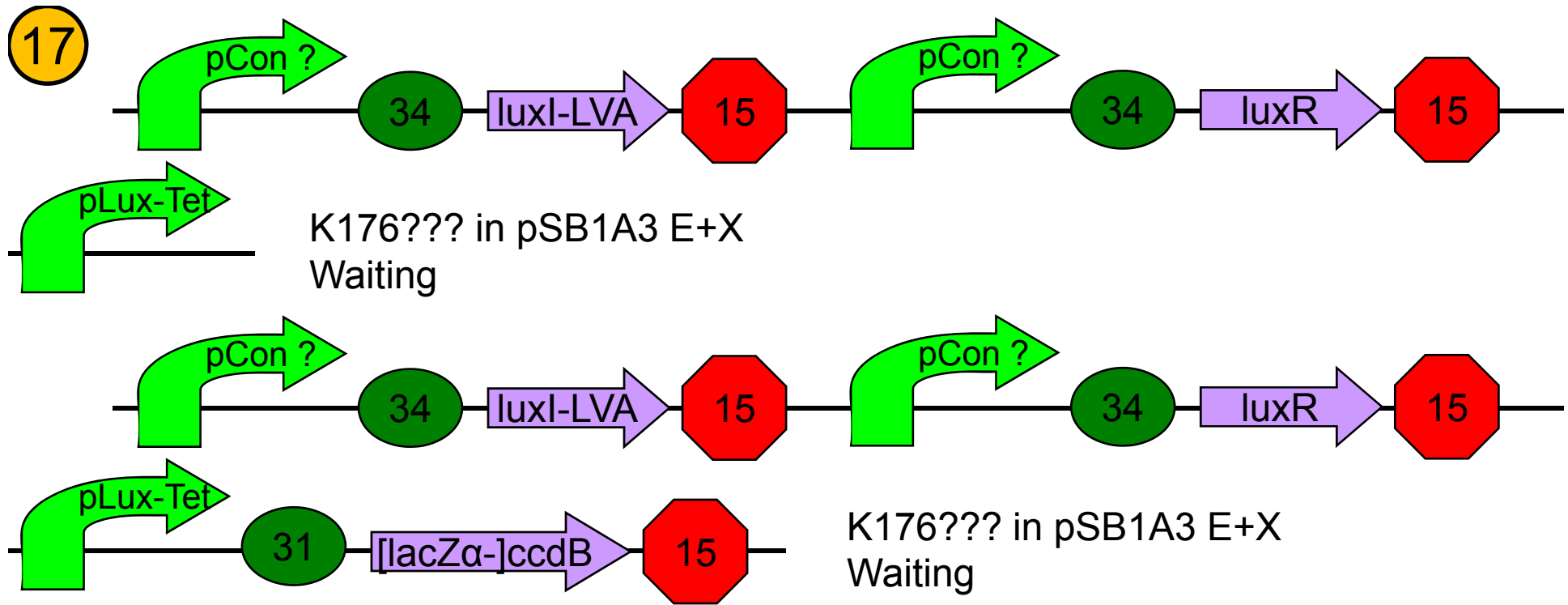

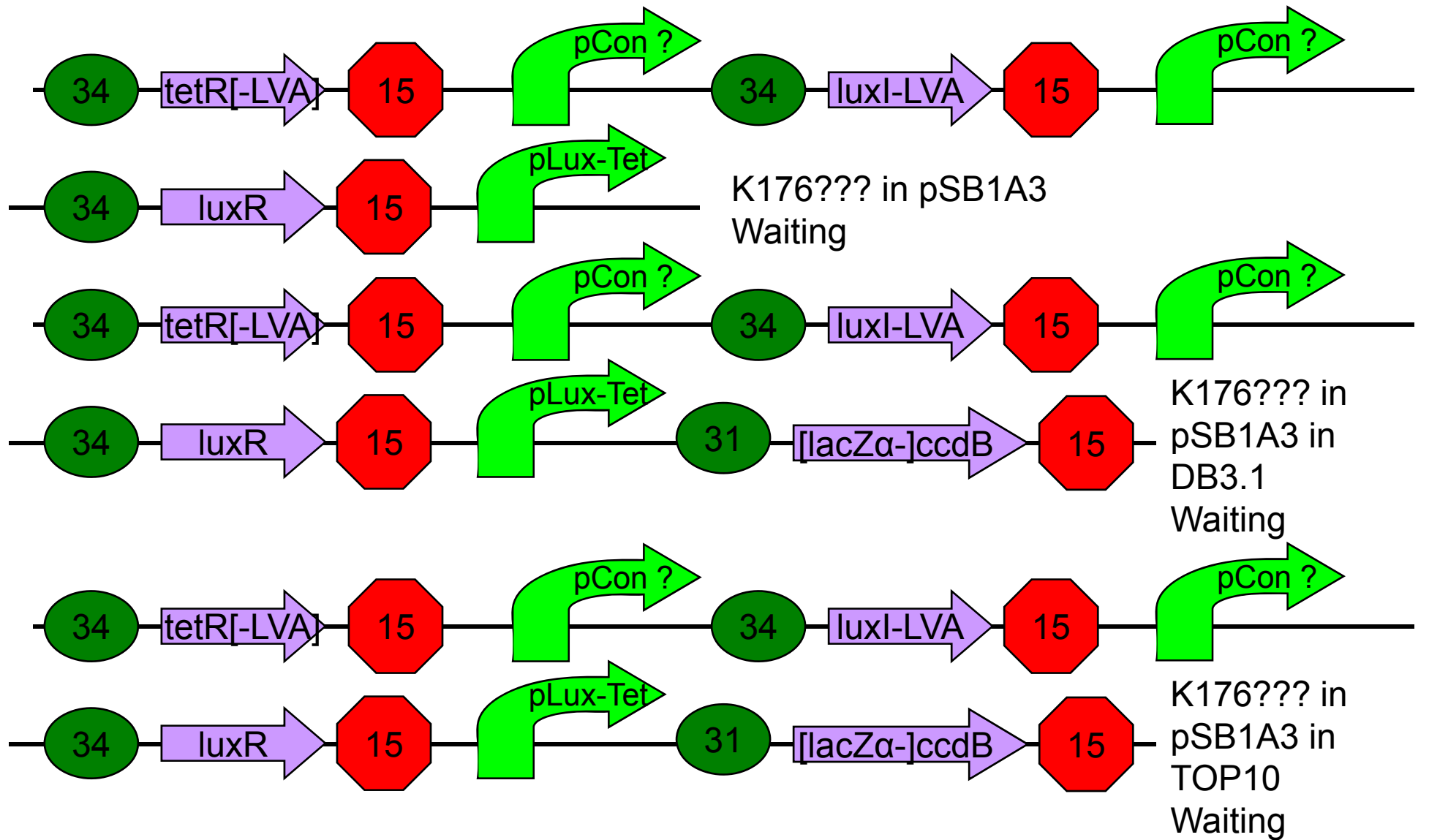

18

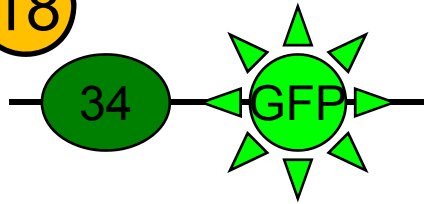

I13500 in pSB1A2
Sequence OK

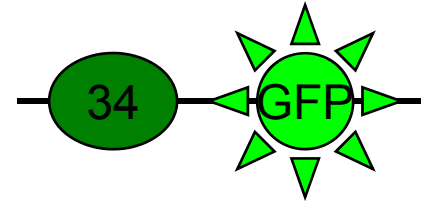

I13500 in pSB1A2 S+P
Length OK

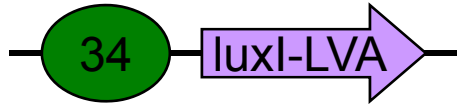

C0261 in pSB1A2
Sequence OK

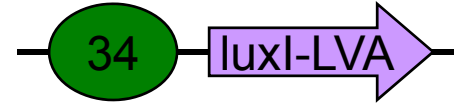

C0261 X+P
Length OK

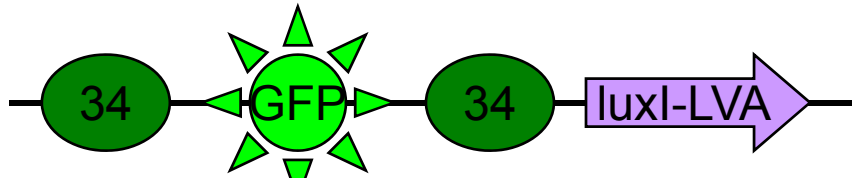

K176106 in pSB1A2
Sequence OK

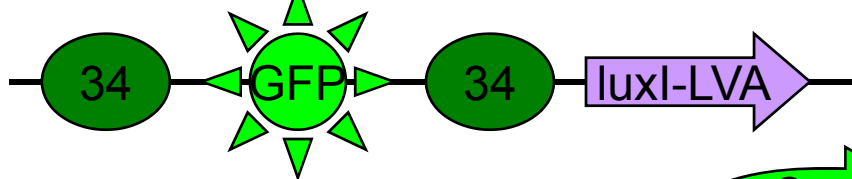

K176106 E+S
Digestion

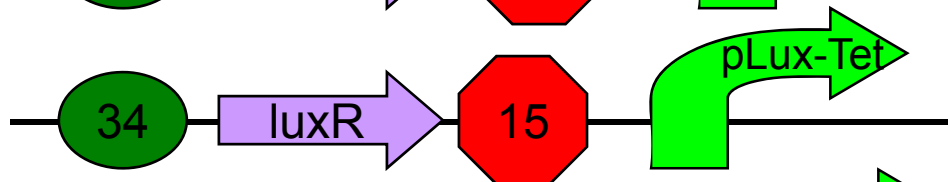
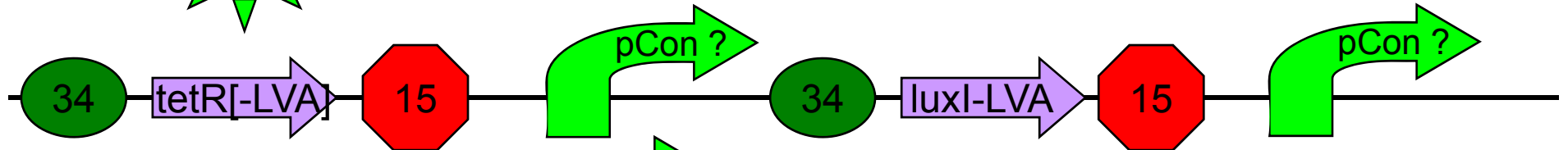

K176??? in pSB1A3 S+P
Waiting

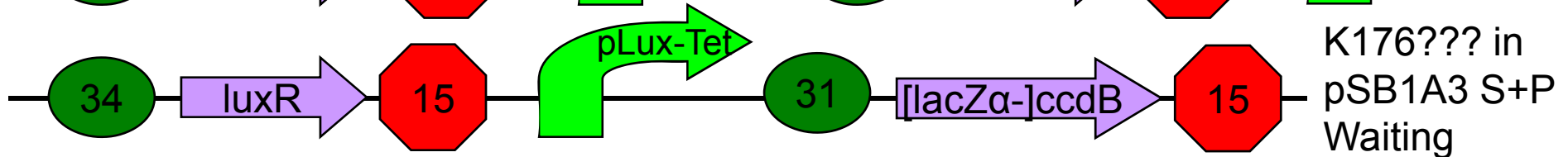
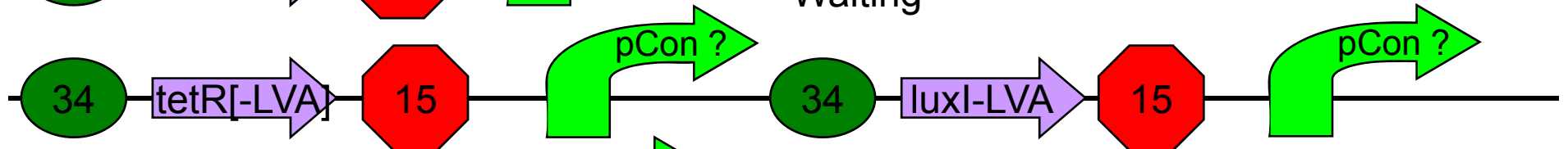

K176??? in
pSB1A3 S+P
Waiting

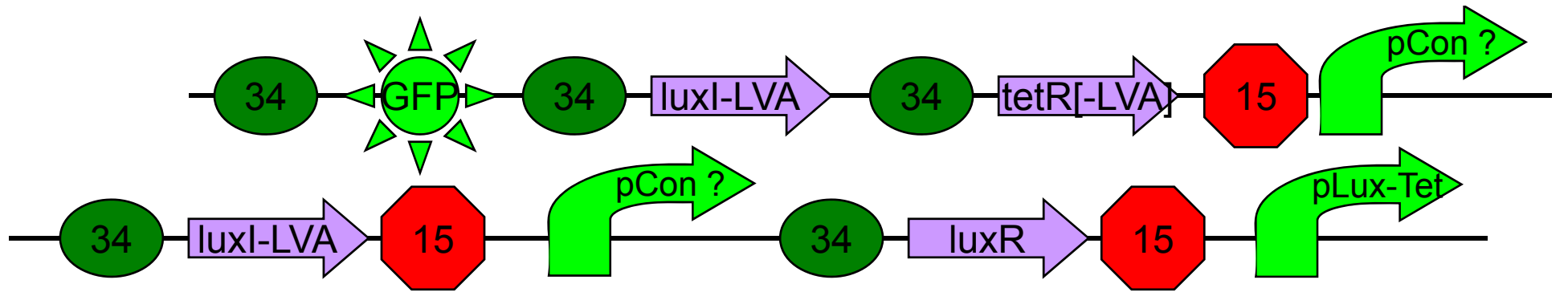

K176??? in pSB1A3
Waiting

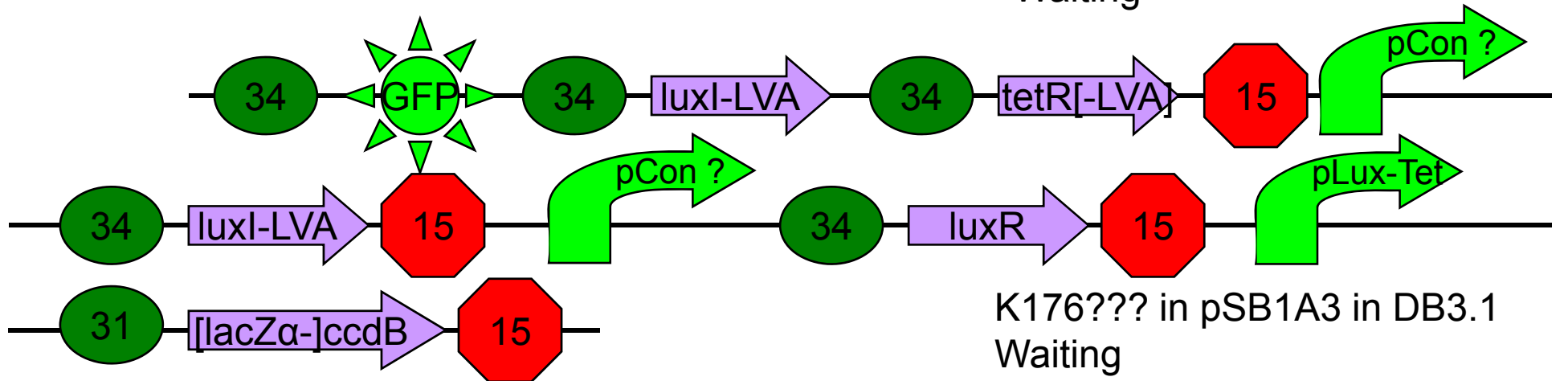

K176??? in pSB1A3 in DB3.1
Waiting

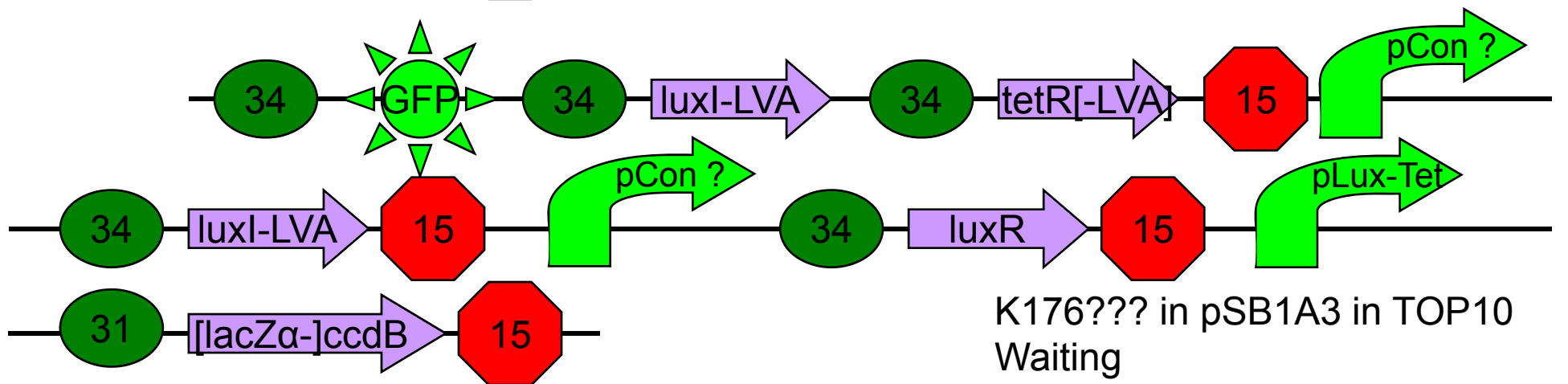

K176??? in pSB1A3 in TOP10
Waiting

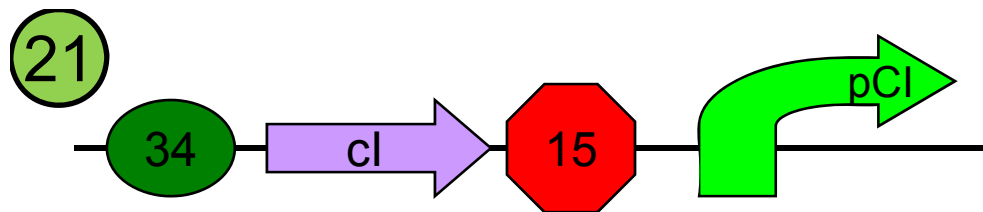

Q04510 in pSB2K3
Sequence OK

22

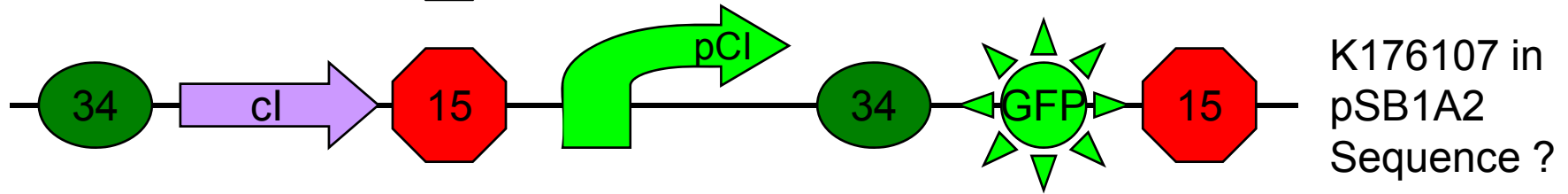
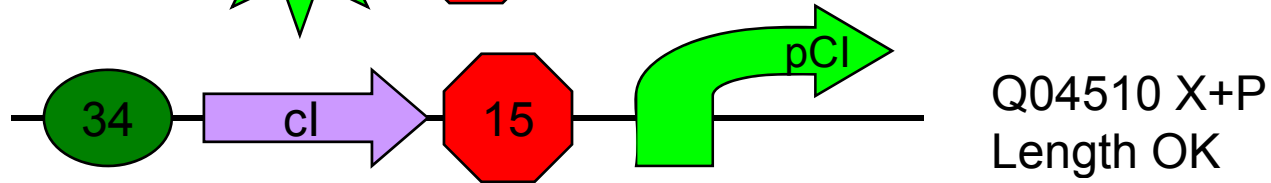
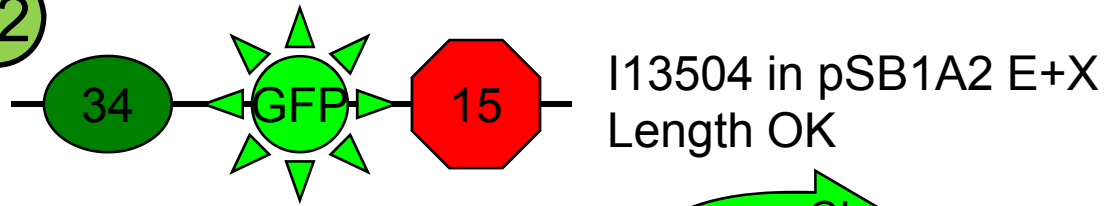

23

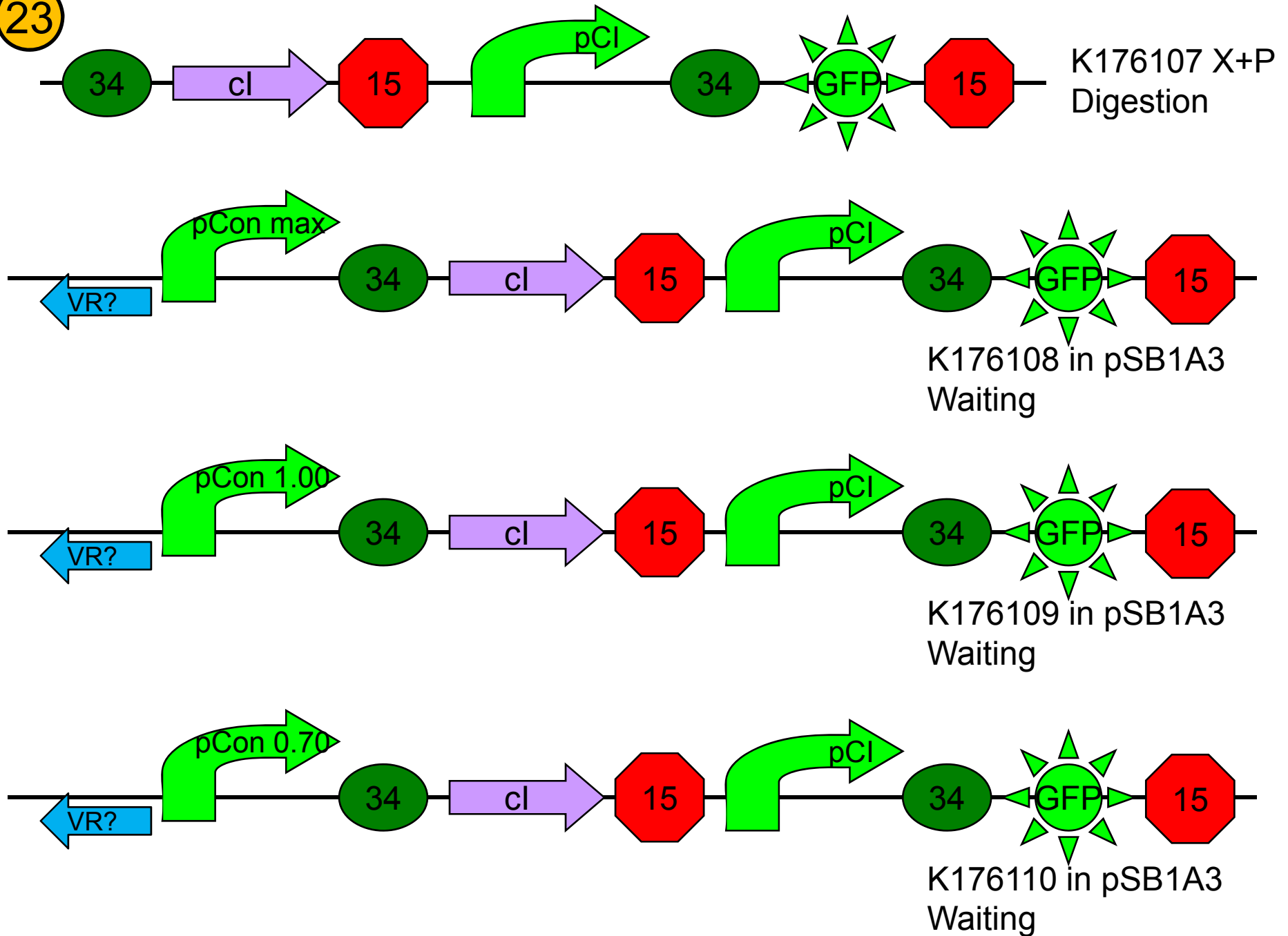

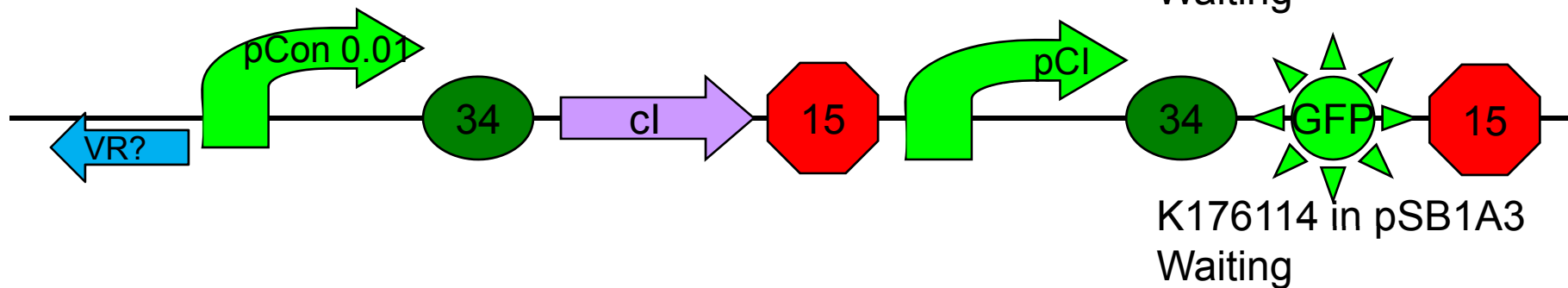
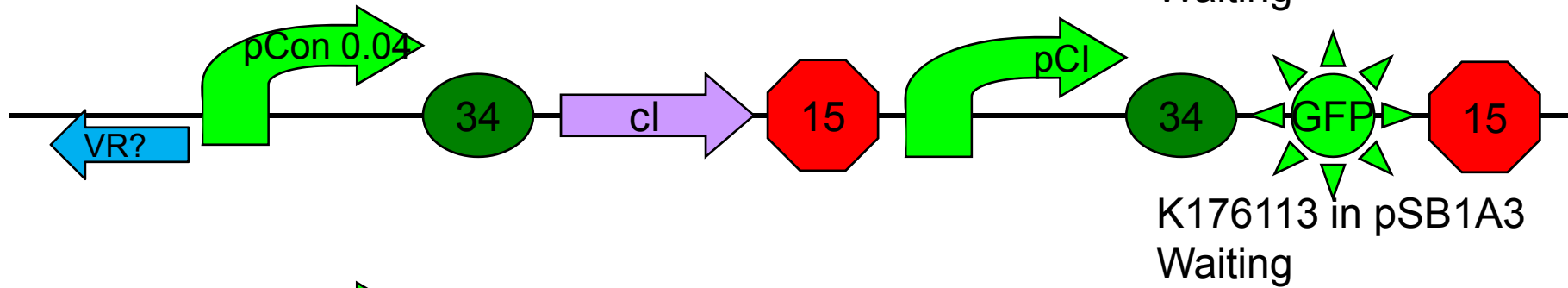
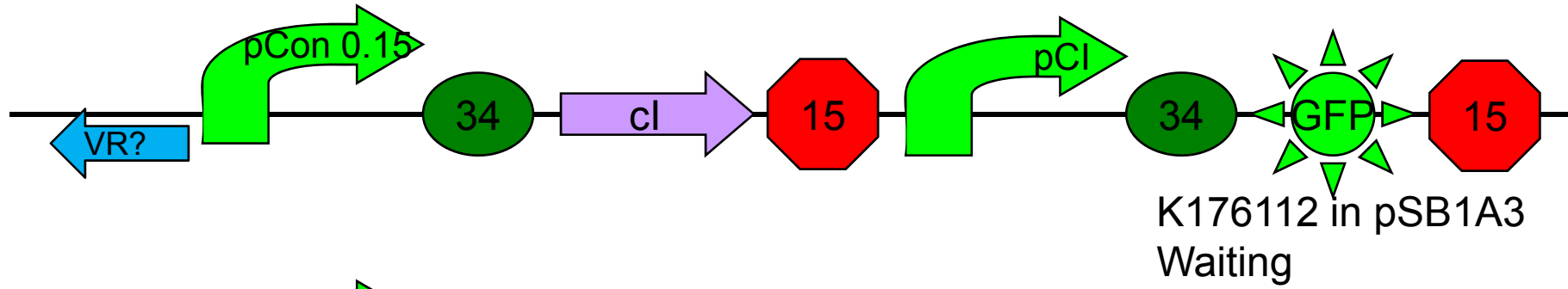
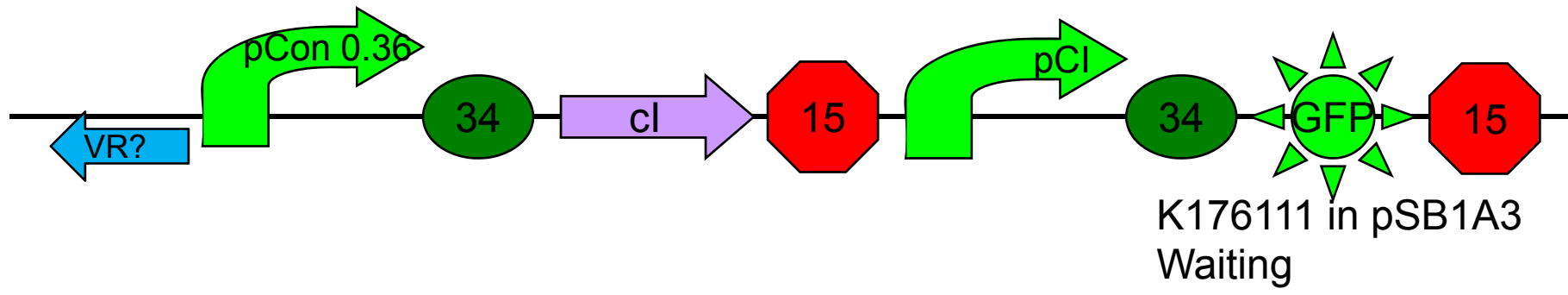

Measurement

- Strain
 - TOP10
 - DH5 α
 - MG1655
 - MDS 42 recA Blue
- Plasmid
- Medium
 - LB
 - M9
 - Minimal
 - Supplemented
 - EZ Rich Define
 - pH-buffered TBK
 - pH-buffered LBK
- pH
- Temperature
 - 37°C
 - 30°C
 - 34°C
- Pre-warm
- Shake
- Dilution
- Wash

Wiki

- Team project description
- Notebook
 - Meetings
 - Lab Work
 - Sample Naming Sheets
- Logo
- Team
- Other pages

Thank You