

# Standard assembly

Teach the Teachers Workshop  
May 16, 2009

# BioBrick standard parts



# BioBrick standard assembly

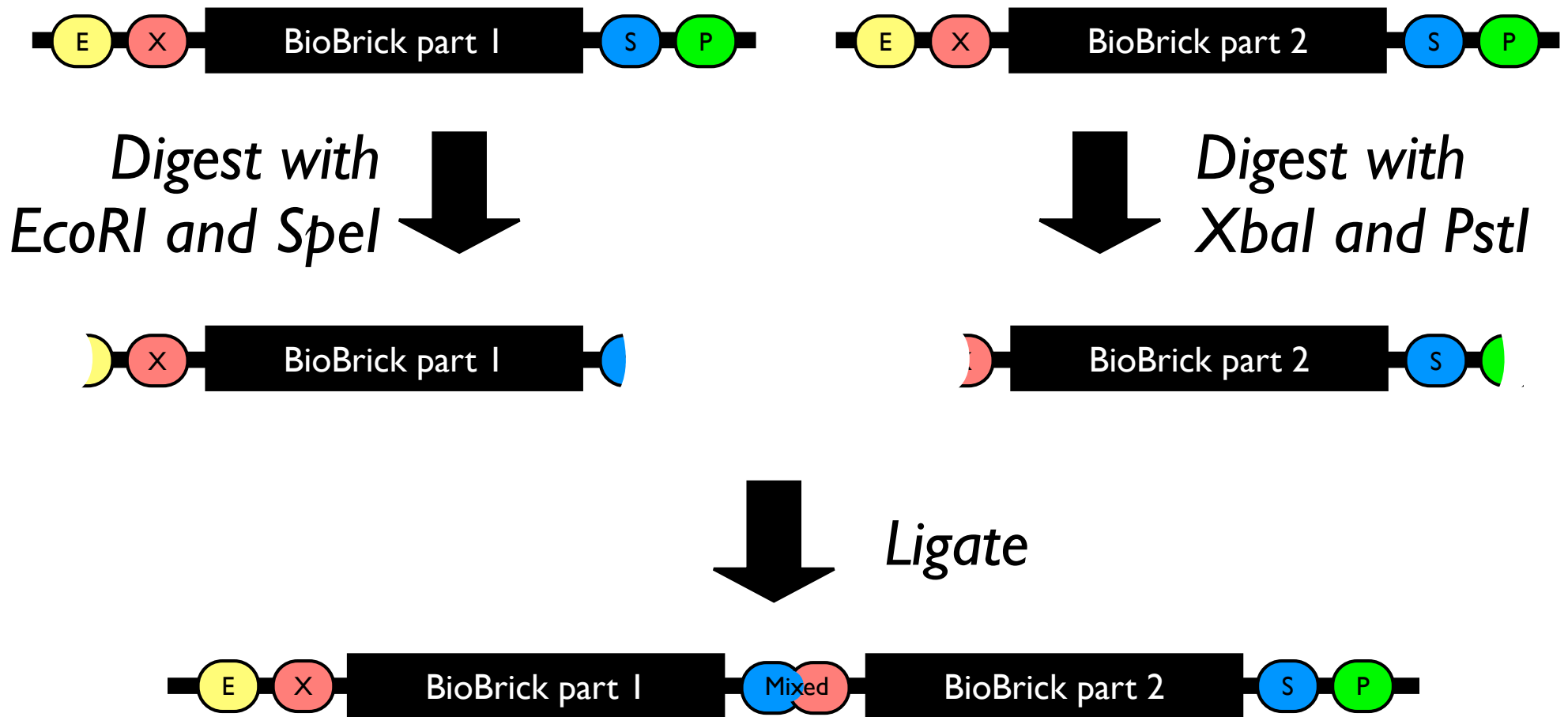

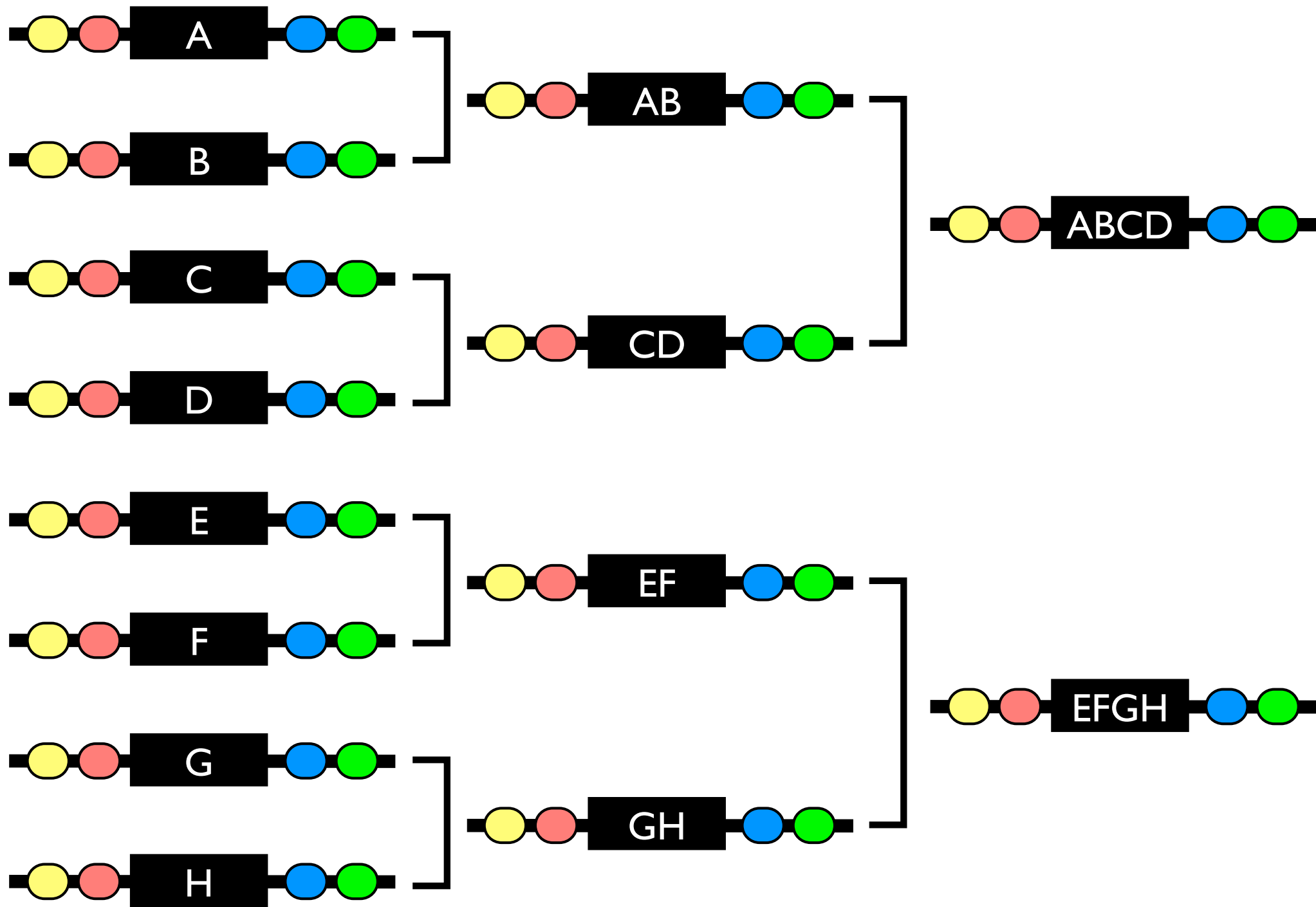

# Why use the BioBrick standard?

- It is faster to build multi-part systems
- Assembling every two parts is the same
- You can reuse parts from the Registry
- Other people can reuse your parts
- It is required to win a prize at iGEM!

# BioBrick™ Assembly Kit

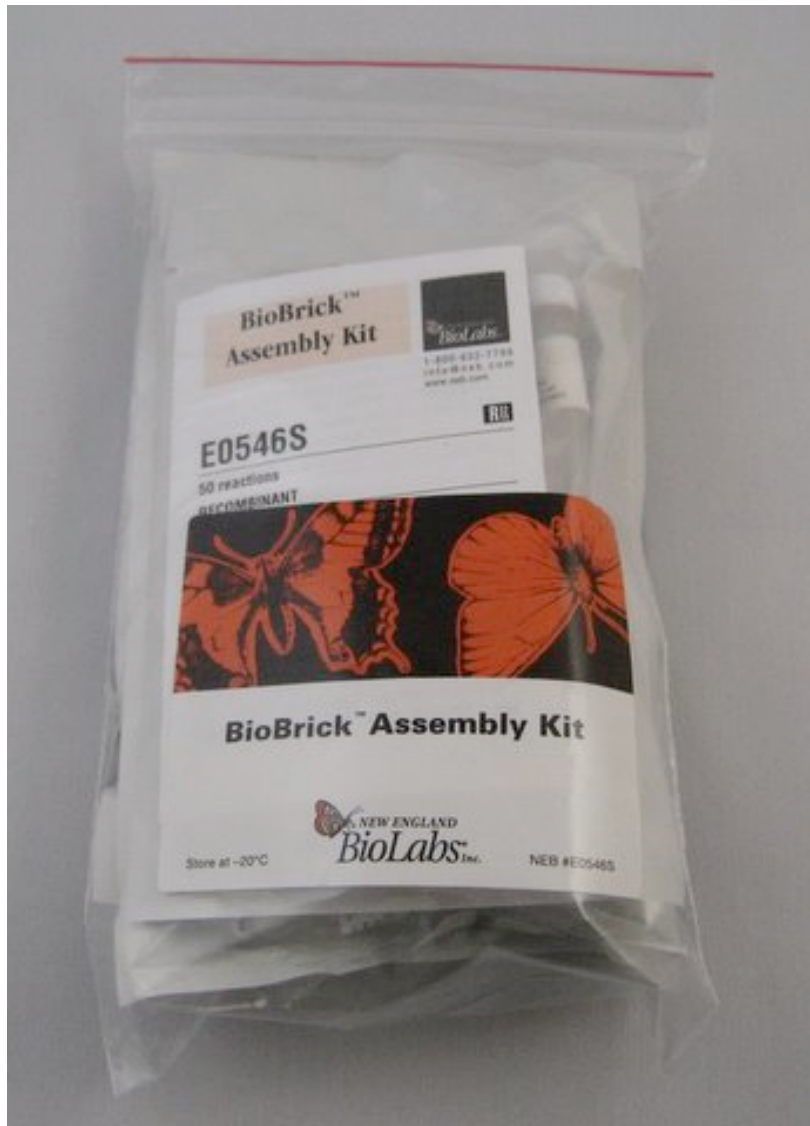

Get the  
enzymes  
cheaper

# BioBrick™ Assembly Manual

This manual describes the major steps of BioBrick assembly using BioBrick Assembly Standard 1.0. The input to the protocol is DNA for the two parts to be assembled and a destination plasmid. The manual includes protocols for the digestion of the three input DNA molecules and the ligation of the digested DNA to

form a circularized plasmid containing the composite part. The product of the ligation reaction can be used to transform competent cells with the composite part. To read more about the BioBrick system and browse the BioBrick collection, visit the Registry of Standard Biological Parts at <http://partsregistry.org>.

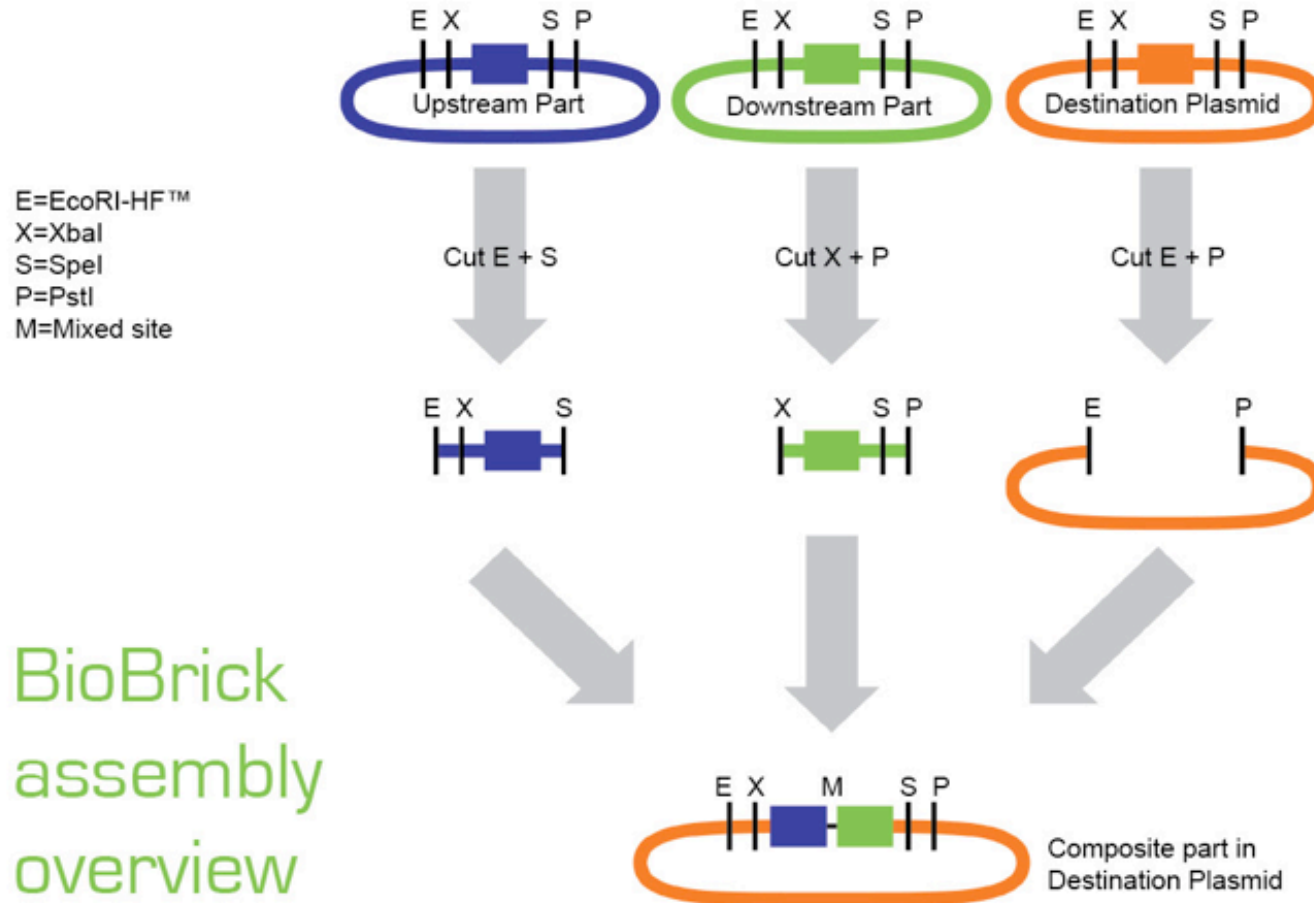

**1** Start with two BioBrick parts and a BioBrick destination plasmid. The destination plasmid contains a toxic gene, *ccdB*, in the BioBrick cloning site and a different antibiotic resistance marker to the upstream and downstream parts.

**2** Digest each of the parts with the appropriate restriction enzymes.

**3** Mix the digests together and perform a ligation step. One of the ligation products formed will be the correctly assembled composite part in the destination plasmid. You can use the ligation mix to transform competent cells with the new composite part.

The BioBrick™ Assembly Kit from NEB and Ginkgo BioWorks has been designed for use with this manual. Download this manual from <http://ginkgobioworks.com/support>

BioBrick  
assembly  
overview

# materials

## consumables

- A Restriction enzymes (EcoRI-HF, XbaI, SpeI, PstI), NEBuffer 2, BSA
- B 10X T4 DNA Ligase Reaction Buffer, T4 DNA Ligase
- C H<sub>2</sub>O (not shown)
- D Small PCR tubes
- E 2 µl, 200µl pipet tips
- F Destination plasmid as purified DNA
- G Upstream and downstream parts as purified DNA

## equipment

- H 2 µl and 20 µl pipet
- I Incubator/water bath/thermocycler capable of holding 37°C and 80°C (not shown)
- J Timer
- K Rack for small PCR tubes

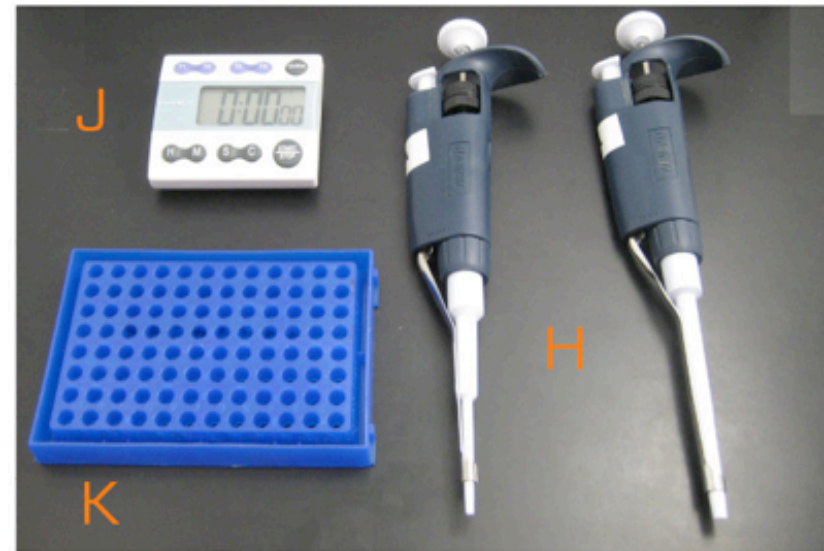
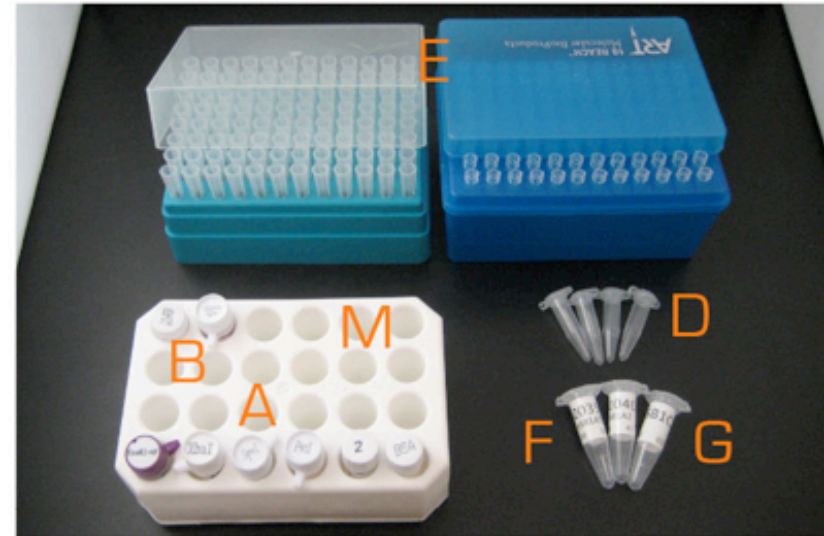



# digest

**!** This protocol assumes you have purified DNA for each of the BioBrick parts you want to assemble and also that you have purified DNA for the destination plasmid. The DNA could be produced from a DNA miniprep or a PCR amplification from a template. If the DNA was produced via a PCR amplification, the protocol assumes the DNA has been purified from the PCR enzymes that can reduce ligation efficiency.

The destination plasmid must have a different antibiotic resistance than the plasmids carrying the parts to be assembled, otherwise, many of the colonies obtained after transformation of competent cells will contain the input BioBrick parts, and not the composite BioBrick part. The toxic gene in the BioBrick cloning site of the destination plasmid ensures that cells transformed with undigested destination plasmid will not grow.

## prepare reaction mix

**1** Remove the DNA for the upstream part, the downstream part and the destination plasmid along with NEBuffer 2 and BSA from the freezer to thaw. Thawing is fast if the tubes are immersed in room temperature water. You can also remove the enzymes from the freezer but leave them in a cold box so they remain close to  $-20^{\circ}\text{C}$ .



**2** You will need three PCR tubes, one for the digest of the upstream part, one for the downstream part, and one for the destination plasmid. You should label each tube (for example, U, D, P, for upstream part, downstream part, and destination plasmid respectively).

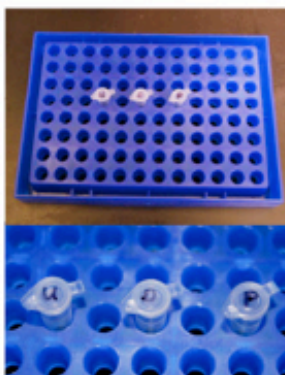

**3** To each tube, add  $\text{H}_2\text{O}$  and 500 ng of the part or plasmid to be digested. Adjust the amount of water you add such that the total volume in each tube is 42.5  $\mu\text{l}$ .

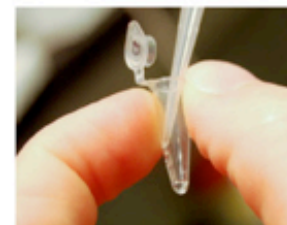

**4** Add 5  $\mu\text{l}$  of NEBuffer 2 to each tube.



**5** Add 0.5  $\mu\text{l}$  of BSA to each tube.



**6** Add 1  $\mu\text{l}$  of the first appropriate\* restriction enzyme to each tube\*\*.



**7** Add 1  $\mu\text{l}$  of the second appropriate\* restriction enzyme to each tube\*\*.

\* See the overview diagram on Page 1 for the appropriate restriction enzymes for each part and the destination plasmid.

\*\* When pipeting restriction enzyme, only touch the very end of the pipet tip into the restriction enzyme. Restriction enzymes are stored in a high percentage glycerol solution that sticks to the outside of the pipet tip. If you dip the tip deeply into the restriction digest you will add much more restriction digest than needed as well as increase the glycerol concentration of the digest mix. A high glycerol concentration (>5%) can result in non-specific cutting of the DNA (referred to as "star activity").

# brick layer

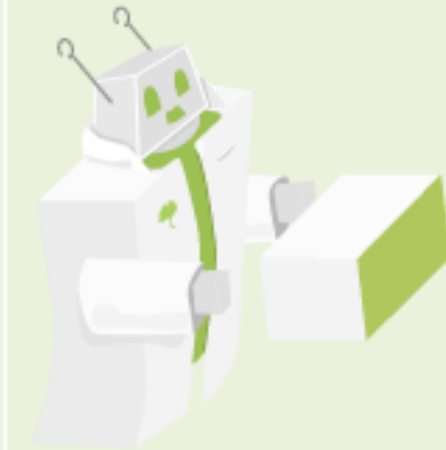

A fast, reliable,  
BioBrick assembly  
service from the  
Ginkgo bots

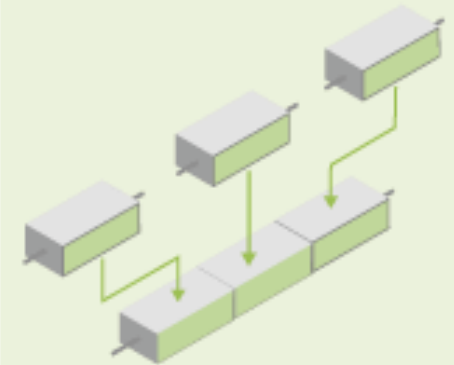

## The details

- All assemblies use **BioBrick™ assembly standard 10**.
- Orders can be submitted via email.
- Ginkgo engineers will consult on the selection of parts.
- Assemblies are sent in two weeks. Faster assembly is available for standard registry parts.

## Coming Summer 2009

Keep me informed...

# Plasmid backbones

Teach the Teachers Workshop  
May 16, 2009

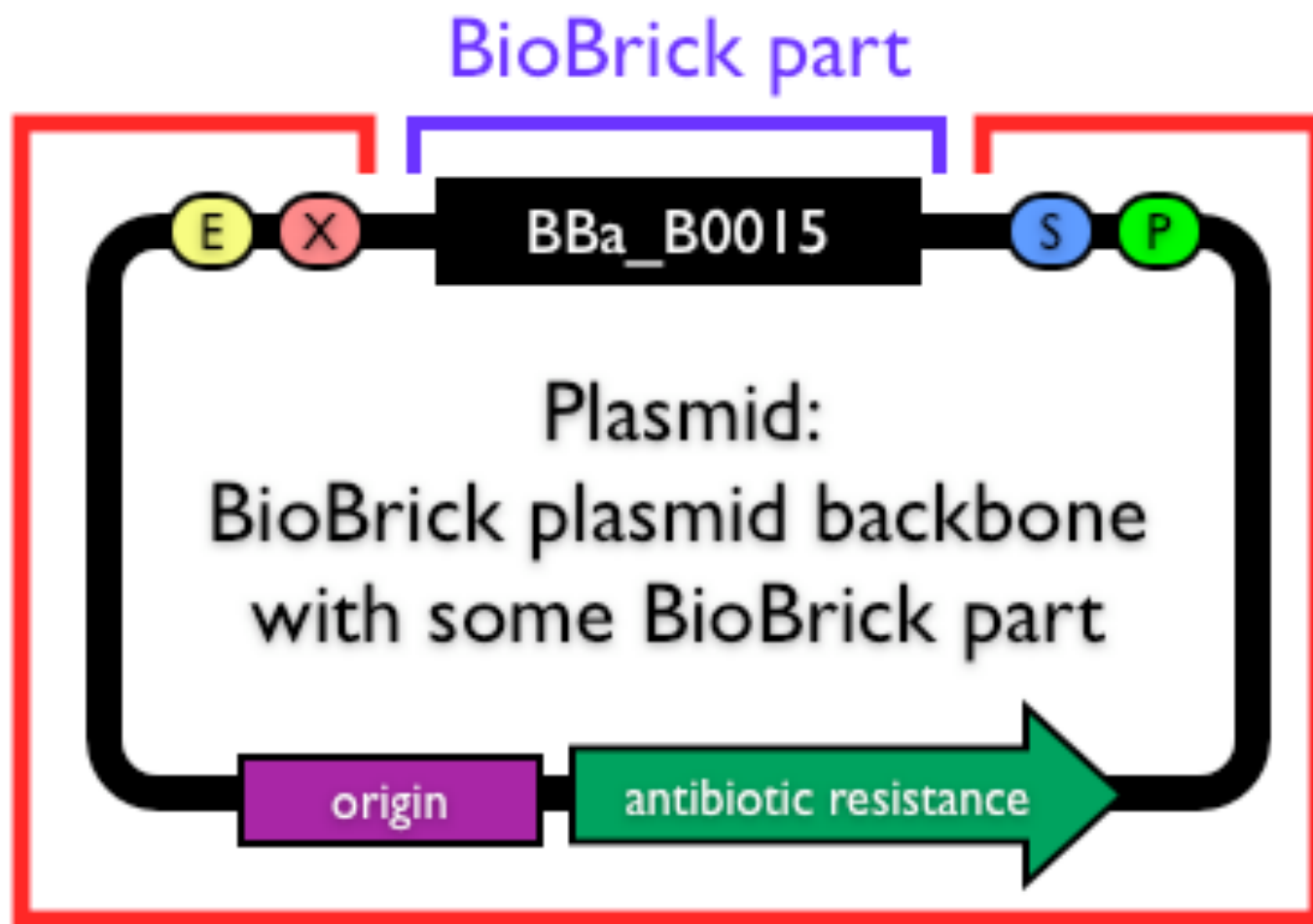

BioBrick plasmid backbone